



# ISONIC 2007

Dual Channel Portable Digital Ultrasonic Flaw Detector and Recorder  
Operating Manual  
Revision 1.14



**Sonotron NDT**



Information in this document is subject to change without notice. No part of this document may be reproduced or transmitted in any form or by any means, electronic or mechanical, for any purpose, without the express written permission of:

**Sonotron NDT, 4, Pekeris st., Rabin Science Park, Rehovot, Israel, 76702**

Covered by the United States patents **5524627**, **5952577**, **6545681**; other US & foreign patents pending



## Sonotron NDT

4, Pekeris str., Rabin Science Park, Rehovot, 76702, Israel  
Phone:++972-(0)8-9477701 Fax:++972-(0)8-9477712  
<http://www.sonotronndt.com>

### EC Declaration of Conformity

**Council Directive 89/336/EEC on Electromagnetic Compatibility, as amended by Council Directive 92/31/EEC & Council Directive 93/68/EEC Council Directive 73/23/EEC ( Low Voltage Directive ), as amended by Council Directive 93/68/EEC**

We, **Sonotron NDT Ltd.**, 4 Pekeris Street, Rehovot, 76702 Israel, certify that the product described is in conformity with the Directives 73/23/EEC and 89/336/EEC as amended

### ISONIC 2007

#### Dual Channel Portable Digital Ultrasonic Flaw Detector and Recorder

The product identified above complies with the requirements of above EU directives by meeting the following standards:

#### Safety

EN 61010-1:1993

#### EMC

EN 61326:1997

EN 61000-3-2:1995 /A1:1998 /A2:1998 /A14:2000

EN 61000-3-3:1995





## Sonotron NDT

4, Pekeris str., Rabin Science Park, Rehovot, 76702, Israel  
Phone:++972-(0)8-9477701 Fax:++972-(0)8-9477712  
<http://www.sonotronndt.com>

## Declaration of Compliance

We, **Sonotron NDT Ltd.**, 4 Pekeris Street, Rehovot, 76702 Israel certify that the product described is in conformity with National and International Codes as amended

### ISONIC 2007

#### Dual Channel Portable Digital Ultrasonic Flaw Detector and Recorder

The product identified above complies with the requirements of following National and International Codes:

- ASME Section I – Rules for Construction of Power Boilers
- ASME Section VIII, Division 1 – Rules for Construction of Pressure Vessels
- ASME Section VIII, Division 2 – Rules for Construction of Pressure Vessels. Alternative Rules
- ASME Section VIII Article KE-3 – Examination of Welds and Acceptance Criteria
- ASME Code Case 2235 Rev 9 – Use of Ultrasonic Examination in Lieu of Radiography
- Non-Destructive Examination of Welded Joints – Ultrasonic Examination of Welded Joints. – British and European Standard BS EN 1714:1998
- Non-Destructive Examination of Welds – Ultrasonic Examination – Characterization of Indications in Welds. – British and European Standard BS EN 1713:1998
- Calibration and Setting-Up of the Ultrasonic Time of Flight Diffraction (TOFD) Technique for the Detection, Location and Sizing of Flaws. – British Standard BS 7706:1993
- WI 00121377, Welding – Use Of Time-Of-Flight Diffraction Technique (TOFD) For Testing Of Welds. – European Committee for Standardization – Document # CEN/TC 121/SC 5/WG 2 N 146, issued Feb, 12, 2003
- ASTM E 2373 – 04 – Standard Practice for Use of the Ultrasonic Time of Flight Diffraction (TOFD) Technique
- Non-Destructive Testing – Ultrasonic Examination – Part 5: Characterization and Sizing of Discontinuities. – British and European Standard BS EN 583-5:2001
- Non-Destructive Testing – Ultrasonic Examination – Part 2: Sensitivity and Range Setting. – British and European Standard BS EN 583-2:2001
- Manufacture and Testing of Pressure Vessels. Non-Destructive Testing of Welded Joints. Minimum Requirement for Non-Destructive Testing Methods – Appendix 1 to AD-Merkblatt HP5/3 (Germany).– Edition July 1989



## FCC Rules

This **ISONIC 2007** ultrasonic flaw detector and data recorder (hereinafter called **ISONIC 2007**) has been tested and found to comply with the limits for a Class B digital device, pursuant to Part 15 of the FCC Rules. These limits are designed to provide reasonable protection against harmful interference in a residential installation. This equipment generates, uses and can radiate radio frequency energy and, if not installed and used in accordance with the instructions, may cause harmful interference to radio communications. However, there is no guarantee that interference will not occur in a particular installation. If this equipment does cause harmful interference to radio or television reception, which can be determined by turning the equipment off and on, the user is encouraged to try to correct the interference by one or more of the following measures:

- Reorient or relocate the receiving antenna
- Increase the separation between the equipment and receiver
- Connect the equipment into an outlet on a circuit different from that to which the receiver is connected
- Consult the dealer or an experienced radio/TV technician for help

## Safety Regulations



Please read this section carefully and observe the regulations in order to ensure your safety and operate the system as intended

Please observe the warnings and notes printed in this manual and on the unit

The **ISONIC 2007** has been built and tested according to the regulations specified in EN60950/VDE0805. It was in perfect working condition on leaving the manufacturer's premises

In order to retain this standard and to avoid any risk in operating the equipment, the user must make sure to comply with any hints and warnings included in this manual

Depending on the power supply the **ISONIC 2007** complies with protection class I /protective grounding/, protection class II, or protection class III

### Exemption from statutory liability for accidents

The manufacturer shall be exempt from statutory liability for accidents in the case of non-observance of the safety regulations by any operating person

### Limitation of Liability

The manufacturer shall assume no warranty during the warranty period if the equipment is operated without observing the safety regulations. In any such case, manufacturer shall be exempt from statutory liability for accidents resulting from any operation

### Exemption from warranty

The manufacturer shall be exempt from any warranty obligations in case of the non-observance of the safety regulations  
The manufacturer will only warrant safety, reliability, and performance of the **ISONIC 2007** if the following safety regulations are closely observed:

- Setting up, expansions, re-adjustments, alterations, and repairs must only be carried out by persons who have been authorized by manufacturer
- The electric installations of the room where the equipment is to be set up must be in accordance with IEC requirements
- The equipment must be operated in accordance with the instructions
- Any expansions to the equipment must comply with the legal requirements, as well as with the specifications for the unit concerned
- Confirm the rated voltage of your **ISONIC 2007** matches the voltage of your power outlet
- The mains socket must be located close to the system and must be easily accessible
- Use only the power cord furnished with your **ISONIC 2007** and a properly grounded outlet /only protection class I/
- Do not connect the **ISONIC 2007** to power bar supplying already other devices. Do not use an extension power cord
- Any interruption to the PE conductor, either internally or externally, or removing the earthed conductor will make the system unsafe to use /only protection class I/
- Any required cable connectors must be screwed to or hooked into the casing
- The equipment must be disconnected from mains before opening
- To interrupt power supply, simply disconnect from the mains
- Any balancing, maintenance, or repair may only be carried out by manufacturer authorized specialists who are familiar with the inherent dangers
- Both the version and the rated current of any replacement fuse must comply with specifications laid down
- Using any repaired fuses, or short-circuiting the safety holder is illegal
- If the equipment has suffered visible damage or if it has stopped working, it must be assumed that it can no longer be operated without any danger. In these cases, the system must be switched off and be safeguarded against accidental use
- Only use the cables supplied by manufacturer or shielded data cable with shielded connectors at either end
- Do not drop small objects, such as paper clips, into the **ISONIC 2007**
- Do not put the **ISONIC 2007** in direct sunlight, near a heater, or near water. Leave space around the **ISONIC 2007**
- Disconnect the power cord whenever a thunderstorm is nearby. Leaving the power cord connected may damage the **ISONIC 2007** or your property
- When positioning the equipment, external monitor, external keyboard, and external mouse take into account any local or national regulations relating to ergonomic requirements. For example, you should ensure that little or no ambient light is reflected off the external monitor screen as glare, and that the external keyboard is placed in a comfortable position for typing

- Do not allow any cables, particularly power cords, to trail across the floor, where they can be snagged by people walking past
- The voltage of the External DC Power Supply below 11 V is not allowed for the **ISONIC 2007** unit
- The voltage of the External DC Power Supply above 16 V is not allowed for the **ISONIC 2007** unit
- Charge of the battery for the **ISONIC 2007** unit is allowed only with use of the AC/DC converters / chargers supplied along with it or authorized by Sonotron NDT

Remember this before:

- balancing
- carrying out maintenance work
- repairing
- exchanging any parts

Please make sure batteries, rechargeable batteries, or a power supply with SELV output supplies power

#### **Software**

**ISONIC 2007** is a software controlled inspection device. Based on present state of the art, software can never be completely free of faults. **ISONIC 2007** should therefore be checked before and after use in order to ensure that the necessary functions operate perfectly in the envisaged combination. If you have any questions about solving problems related to use the **ISONIC 2007**, please contact your local Sonotron NDT representative

|  |     |
|--|-----|
| 1. INTRODUCTION .....  | 11  |
| 2. TECHNICAL DATA.....   | 14  |
| 2.1. INSTRUMENTS MANUFACTURED ON OR BEFORE DEC 1, 2007 .....   | 15  |
| 2.2. INSTRUMENTS MANUFACTURED AFTER DEC 1, 2007 .....  | 17  |
| 3. ISONIC 2007 – SCOPE OF SUPPLY.....  | 19  |
| 4. OPERATING ISONIC 2007 .....   | 24  |
| 4.1. PRECONDITIONS FOR ULTRASONIC TESTING WITH ISONIC 2007.....  | 25  |
| 4.2. ISONIC 2007 CONTROLS AND TERMINALS .....  | 26  |
| 4.3. TURNING ON / OFF.....   | 28  |
| 5. UDS 3-5 PULSER RECEIVER CHANNELS.....   | 30  |
| 5.1. START UP UDS 3-5 PULSER RECEIVER.....   | 31  |
| 5.2. MAIN OPERATING SURFACE .....  | 32  |
| 5.2.1. Main Menu.....  | 34  |
| 5.2.2. Sub Menu BASICS .....   | 35  |
| 5.2.3. Sub Menu PULSER.....  | 40  |
| 5.2.4. Sub Menu RECEIVER .....   | 46  |
| 5.2.5. Sub Menu GATE A .....   | 51  |
| 5.2.6. Sub Menu GATE B .....   | 55  |
| 5.2.7. Drag and Drop: Gate A and Gate B .....  | 59  |
| 5.2.8. Sub Menu ALARM.....   | 60  |
| 5.2.9. Sub Menu DAC/TCG .....  | 64  |
| 5.2.10. Create / Modify DAC.....   | 65  |
| 5.2.10.1 Theoretical DAC: dB/mm (dB/in).....   | 65  |
| 5.2.10.2 Experimental DAC: recording signals from variously located reflectors .....   | 67  |
| 5.2.11. DGS.....   | 71  |
| 5.2.12. Sub Menu MEASURE.....  | 83  |
| 5.2.13. Time Domain Signal Evaluation - Measurements Guide.....  | 88  |
| 5.2.13.1. Values available for Automatic Measurements and Digital Readout.....   | 88  |
| 5.2.13.2. Flank, Top, Flank-First, and Top-First Modes of Measurement .....  | 90  |
| 5.2.13.3. Advanced Scheme for Reflectors Depth Measurement Whilst Using Angle Beam Probe – Thickness / Skip / Curved Scanning Surface Correction.....                            | 92  |
| 5.2.13.4. Dual Ultrasound Velocity Measurement Mode – Typical Example.....   | 96  |
| 5.2.13.5. Determining Probe Delay - Miniature Angle Beam Probes (contact face width 12.5 mm / 0.5 in or less) - Shear or Longitudinal Waves – Typical Example.....               | 100 |
| 5.2.13.6. Determining Probe Delay - Large and Medium Size Angle Beam Probes (contact face width more than 12.5 mm / 0.5 in) - Shear or Longitudinal Waves – Typical Example..... | 101 |
| 5.2.13.7. Determining Probe Delay - Straight Beam (Normal) Single Element and Dual (TR) Probes – Typical Example.....  | 102 |
| 5.2.13.8. Automatic Calibration (AUTOCAL) of Probe Delay and US Velocity - Angle Beam Probes - Shear or Longitudinal Waves – Typical Example .....                               | 103 |
| 5.2.13.9. Automatic Calibration of Probe Delay and US Velocity - Straight Beam (Normal) Single Element and Dual (TR) Probes – Typical Example.....                               | 108 |
| 5.2.13.10. Determining Incidence Angle (Probe Angle) .....   | 109 |
| 5.2.14. Frequency Domain Signal Presentation and Evaluation .....  | 110 |
| 5.2.15. Freeze A-Scan / FFT Graph .....  | 116 |
| 5.2.16. Zoom A-Scan / FFT Graph .....  | 117 |
| 5.2.17. Save an A-Scan and its Calibration Dump into a file.....   | 118 |
| 5.2.18. Load an A-Scan and its Calibration Dump from a file .....  | 119 |
| 5.2.19. Print A-Scan/FFT Graph and Settings List.....  | 120 |
| 5.2.20. Activate Main Recording Menu for Single Channel Operation using CH 1 .....   | 120 |
| 5.2.21. Switch OFF UDS 3-5 .....   | 120 |
| 6. RECORDING AND IMAGING – SINGLE CHANNEL (CH 1) .....   | 121 |
| 6.1. MAIN RECORDING MENU – SINGLE CHANNEL (CH 1) .....   | 122 |
| 6.2. TIME BASED AND TRUE TO LOCATION RECORDING SUBMENUS.....   | 123 |
| 6.3. THICKNESS PROFILE IMAGING AND RECORDING – T-BSCAN(TH) AND BSCAN(TH) .....   | 124 |
| 6.3.1. Setup Pulser Receiver for Thickness Profile Imaging and Recording .....   | 124 |
| 6.3.2. Thickness Profile Imaging – Implementation .....  | 126 |
| 6.3.2.1. t-BScan(Th) – Prior to Scanning .....   | 126 |
| 6.3.2.2. t-BScan(Th) – Scanning .....  | 133 |
| 6.3.2.3. BScan(Th) – Prior to Scanning .....   | 134 |
| 6.3.2.4. BScan(Th) – Scanning.....   | 137 |



|  |     |
|--|-----|
| 6.3.2.5. t-BScan(Th) / BScan(Th) – Postprocessing .....  | 138 |
| 6.4. B-SCAN CROSS-SECTIONAL IMAGING AND RECORDING OF DEFECTS FOR LONGITUDINAL AND SHEAR WAVE INSPECTION – T-ABISCAN OR ABISCAN.....                  | 144 |
| 6.4.1. Setup Pulser Receiver for t-ABIScan or ABIScan Imaging and Recording.....   | 144 |
| 6.4.1.1. Straight Beam Probes.....   | 144 |
| 6.4.1.2. Angle Beam Probes.....  | 145 |
| 6.4.2. B-Scan Cross Sectional Imaging – Implementation.....  | 146 |
| 6.4.2.1. t-ABIScan – Prior to Scanning (Straight Beam Probes).....   | 146 |
| 6.4.2.2. t-ABIScan – Scanning (Straight Beam Probes).....  | 151 |
| 6.4.2.3. ABIScan – Prior to Scanning (Straight Beam Probes).....   | 152 |
| 6.4.2.4. ABIScan – Scanning (Straight Beam Probes).....  | 156 |
| 6.4.2.5. t-ABIScan – Prior to Scanning (Angle Beam Probes).....  | 157 |
| 6.4.2.6. t-ABIScan – Scanning (Angle Beam Probes).....   | 163 |
| 6.4.2.7. ABIScan – Prior to Scanning (Angle Beam Probes).....  | 164 |
| 6.4.2.8. ABIScan – Scanning (Angle Beam Probes).....   | 169 |
| 6.4.2.9. t-ABIScan / ABIScan – Postprocessing.....   | 170 |
| 6.5. TOFD INSPECTION – RF B-SCAN AND D-SCAN IMAGING AND RECORDING – T-TOFD OR TOFD.....  | 181 |
| 6.5.1. Setup Pulser Receiver for t-TOFD and TOFD.....  | 181 |
| 6.5.1.1. Accumulated Probe Pair Delay.....   | 182 |
| 6.5.1.2. Display Delay and Range.....  | 186 |
| 6.5.1.3. Gain.....   | 187 |
| 6.5.1.4. Probe Separation.....   | 188 |
| 6.5.2. t-TOFD and TOFD – Implementation.....   | 189 |
| 6.5.2.1. t-TOFD – Prior to Scanning.....   | 189 |
| 6.5.2.2. t-TOFD – Scanning.....  | 196 |
| 6.5.2.3. TOFD – Prior to Scanning.....   | 197 |
| 6.5.2.4. TOFD – Scanning.....  | 202 |
| 6.5.2.5. t-TOFD / TOFD – Postprocessing.....   | 203 |
| 6.6. CB-SCAN HORIZONTAL PLANE-VIEW IMAGING AND RECORDING OF DEFECTS FOR SHEAR, SURFACE, AND GUIDED WAVE INSPECTION – T-FLOORMAP L OR FLOORMAP L..... | 227 |
| 6.6.1. Setup Pulser Receiver for t-FLOORMAP L and FLOORMAP L.....  | 227 |
| 6.6.1.1. Angle Beam Inspection – Shear and Longitudinal Waves.....   | 227 |
| 6.6.1.2. Guided, Surface, Creeping, and Head Wave Inspection.....  | 228 |
| 6.6.1.3. Determining Probe Delay and Ultrasound Velocity for Guided / Surface / Creeping / Head Wave Inspection.....                                 | 229 |
| 6.6.1.4. Setting Gain and DAC for Guided / Surface / Creeping / Head Wave Inspection.....  | 230 |
| 6.6.2. t-FLOORMAP L and FLOORMAP L – Implementation.....   | 231 |
| 6.6.2.1. t-FLOORMAP L – Prior to Scanning.....   | 231 |
| 6.6.2.2. t-FLOORMAP L – Scanning.....  | 236 |
| 6.6.2.3. FLOORMAP L – Prior to Scanning.....   | 237 |
| 6.6.2.4. FLOORMAP L – Scanning.....  | 240 |
| 6.6.2.5. t-FLOORMAP L / FLOORMAP L – Postprocessing.....   | 241 |
| 7. RECORDING AND IMAGING – DUAL CHANNEL.....   | 255 |
| 7.1. MAIN RECORDING MENU – DUAL CHANNEL.....   | 256 |
| 7.2. DUAL CHANNEL THICKNESS PROFILE IMAGING AND RECORDING – BSCAN(Th).....   | 257 |
| 7.2.1. Setting Pulser Receiver Channels.....   | 257 |
| 7.2.2. Scanning.....   | 257 |
| 7.2.3. Postprocessing.....   | 260 |
| 7.3. DUAL CHANNEL TOFD INSPECTION – RF B-SCAN AND D-SCAN IMAGING AND RECORDING.....  | 263 |
| 7.3.1. Setting Pulser Receiver Channels.....   | 263 |
| 7.3.2. Pre-Scanning Settings.....  | 263 |
| 7.3.3. Scanning.....   | 268 |
| 7.3.4. Postprocessing.....   | 270 |
| 7.4. CB-SCAN HORIZONTAL PLANE-VIEW IMAGING AND RECORDING OF DEFECTS FOR SHEAR, SURFACE, AND GUIDED WAVE INSPECTION – FLOORMAP L.....                 | 273 |
| 7.4.1. Setting Pulser Receiver Channels.....   | 273 |
| 7.4.2. Pre-Scanning Settings.....  | 273 |
| 7.4.3. Scanning.....   | 275 |
| 7.4.4. Postprocessing.....   | 277 |
| 8. INCREMENTAL ENCODERS.....   | 280 |
| 8.1. STANDARD ENCODER SK 2001108 ABI – SINGLE CHANNEL OPERATION.....   | 281 |
| 8.2. STANDARD ENCODER SK 2001108 FM – SINGLE CHANNEL OPERATION.....  | 282 |
| 8.2.1. TOFD.....   | 282 |
| 8.2.2. FLOORMAP L.....   | 283 |
| 8.3. CUSTOMIZED ENCODERS FOR PROPRIETARY INSPECTION TASKS – SINGLE AND DUAL CHANNEL OPERATION.....   | 284 |
| 8.4. ENCODER CALIBRATION.....  | 284 |

|   |     |
|---|-----|
| 9. MISCELLANEOUS .....  | 289 |
| 9.1. INTERNATIONAL SETTINGS .....   | 290 |
| 9.1.1. Language .....   | 291 |
| 9.1.2. Metric and Imperial Units .....  | 292 |
| 9.2. DISPLAY SETTINGS .....   | 293 |
| 9.2.1. A-Scan Color Scheme .....  | 293 |
| 9.2.2. TOFD Display Settings .....  | 295 |
| 9.3. FIRING MODE .....  | 299 |
| 9.4. PRINTER SELECTION .....  | 300 |
| 9.5. EXIT TO WINDOWS .....  | 301 |
| 9.6. CONNECTION TO NETWORK .....  | 301 |
| 9.7. EXTERNAL USB DEVICES .....   | 302 |
| 9.7.1. Mouse .....  | 302 |
| 9.7.2. Keyboard .....   | 302 |
| 9.7.3. Memory Stick (Disk on Key) .....   | 302 |
| 9.7.4. Printer .....  | 302 |
| 9.7.5. ISONIC Alarmer .....   | 303 |
| 9.8. EXTERNAL VGA SCREEN / VGA PROJECTOR .....                                  | 306 |
| 9.9. SOFTWARE UPGRADE .....   | 306 |
| 9.9. ISONIC OFFICE AND ISONIC OFFICE 2005 SOFTWARE PACKAGES FOR OFFICE PC ..... | 307 |
| 9.10. ISONIC PAR2TXT CONVERTER SOFTWARE PACKAGE .....                           | 307 |
| 9.11. ISONIC D-LINE AND ISONIC D-SPREADSHEET CREATOR SOFTWARE PACKAGES .....    | 309 |
| 9.12. CHARGING BATTERY .....  | 313 |
| 9.13. SILICON RUBBER JACKET .....   | 314 |
| 10. DUAL CHANNEL TOFD PREAMPLIFIER .....  | 319 |

# 1. Introduction

**ISONIC 2007** uniquely combines functionality and mobility of high performance single/dual portable digital ultrasonic flaw detector with recording, imaging, and data processing capabilities of smart computerized inspection system

**ISONIC 2007** resolves a *variability of ultrasonic inspection tasks*:

- **A-Scan-based inspection** using conventional pulse echo, back echo attenuation, and through transmission techniques
- **Single Channel Straight Line Scanning Record - based inspection:**
  - **Thickness Profile B-Scan** imaging and recording, which is performed through continuous measuring of thickness value along straight line type probe trace
  - **B-Scan cross-sectional imaging and recording of defects** for longitudinal and shear wave inspection, which is performed through continuous measuring of echo amplitudes and reflectors coordinates along straight line type probe trace
  - **CB-Scan horizontal plane-view imaging and recording** of defects for shear, surface, and guided wave inspection, which is performed through continuous measuring of echo amplitudes and reflectors coordinates along straight line type probe trace
  - **TOFD Inspection – RF B-Scan and D-Scan Imaging** along straight line type probe traceFor *Single Channel Straight Line Scanning* records it may be used:
  - *Time-based mode* – **ISONIC 2007** is equipped with built-in real time clock
  - *True-to-location mode* – **ISONIC 2007** is equipped with built-in incremental encoder interface
- **Dual Channel Straight Line Scanning Record - based inspection:**
  - **Thickness Profile B-Scan** imaging and recording, which is performed through continuous measuring of thickness value along straight line type probe trace
  - **CB-Scan horizontal plane-view imaging and recording** of defects for shear, surface, and guided wave inspection, which is performed through continuous measuring of echo amplitudes and reflectors coordinates along straight line type probe trace
  - **TOFD Inspection – RF B-Scan and D-Scan Imaging** along straight line type probe traceFor *Dual Channel Straight Line Scanning* records it may be used:
  - *True-to-location mode* – **ISONIC 2007** is equipped with built-in incremental encoder interface
- **XY-Scanning Record - based inspection:**
  - **Thickness Map** imaging and recording, which is performed through continuous measuring of thickness value along probe trace
  - **Flaw Detection – Pulse Echo 3D imaging (C-Scan, B-Scan, D-Scan) and recording of defects** for straight beam inspection, which is performed through continuous measuring of echo amplitudes and reflectors coordinates along probe trace
  - **Flaw Detection – Through Transmission / Back Echo Attenuation 2D imaging and recording (C-Scan)** which is performed through continuous measuring of signal amplitudes along probe traceFor *XY-Scanning* records it is necessary to use optional items such as scanning mechanism driven either manually or automatically, 2 incremental encoders built-in into a scanning mechanism, dual axis encoder USB Interface, and **MULTISCAN COMBO S ME** inspection software package

For all types of *Straight Line Scanning* and *XY-Scanning* records A-Scans are captured for each probe position along probe trace and may be played back and evaluated off-line at postprocessing stage. This unique feature makes it possible **off-line defect characterization through echo-dynamic pattern analysis**

**Thickness Profile B-Scan Data** recorded during *Straight Line Scanning* and **Thickness Map** data recorded during *XY-Scanning* is presented in the format compatible with various *Risk Based Inspection and Maintenance* procedures. Off-line measurements and statistical analysis functions also meet the requirements of said procedures

**ISONIC 2007** has practically unlimited capacity for storing of

- Single **A-Scans** accompanied with corresponding instrument settings
- Ultrasonic signal spectrum graphs (FFT Graphs) accompanied with corresponding RF **A-Scans** and instrument settings
- Various **A-Scans** sequences along with corresponding Thickness Profiles, or **B-Scans**, or **CB-Scans**, or **TOFD** Maps depending on mode of operation selected accompanied with corresponding instrument settings

**ISONIC 2007** complies with the requirements of National and International Codes:

- ❑ ASME Section I – Rules for Construction of Power Boilers
- ❑ ASME Section VIII, Division 1 – Rules for Construction of Pressure Vessels
- ❑ ASME Section VIII, Division 2 – Rules for Construction of Pressure Vessels. Alternative Rules
- ❑ ASME Section VIII Article KE-3 – Examination of Welds and Acceptance Criteria
- ❑ ASME Code Case 2235 Rev 9 – Use of Ultrasonic Examination in Lieu of Radiography
- ❑ Non-Destructive Examination of Welded Joints – Ultrasonic Examination of Welded Joints. – British and European Standard BS EN 1714:1998
- ❑ Non-Destructive Examination of Welds – Ultrasonic Examination – Characterization of Indications in Welds. – British and European Standard BS EN 1713:1998
- ❑ Calibration and Setting-Up of the Ultrasonic Time of Flight Diffraction (TOFD) Technique for the Detection, Location and Sizing of Flaws. – British Standard BS 7706:1993
- ❑ WI 00121377, Welding – Use Of Time-Of-Flight Diffraction Technique (TOFD) For Testing Of Welds. – European Committee for Standardization – Document # CEN/TC 121/SC 5/WG 2 N 146, issued Feb, 12, 2003
- ❑ Non-Destructive Testing – Ultrasonic Examination – Part 5: Characterization and Sizing of Discontinuities. – British and European Standard BS EN 583-5:2001
- ❑ Non-Destructive Testing – Ultrasonic Examination – Part 2: Sensitivity and Range Setting. – British and European Standard BS EN 583-2:2001
- ❑ Manufacture and Testing of Pressure Vessels. Non-Destructive Testing of Welded Joints. Minimum Requirement for Non-Destructive Testing Methods – Appendix 1 to AD-Merkblatt HP5/3 (Germany).– Edition July 1989

## 2. Technical Data

## 2.1. Instruments manufactured on or before Dec 1, 2007

|   |   |
|---|---|
| Pulse Type*:  | Positive Spike Pulse / Positive Square Wave Pulse   |
| Initial Transition*:                                | ≤5 ns (10-90%)  |
| Pulse Amplitude*:                                   | Spike pulse - smoothly tunable (18 levels) 50 V ... 400 V into 50 Ω at 4 levels of excitation Energy<br>Square wave pulse - smoothly tunable (18 levels) 50V ... 400 V into 50 Ω  |
| Pulse Duration*:                                    | Spike pulse - 10...70 ns for 50 Ω load depending on Energy and Damping setup<br>Square wave pulse - 65...600 ns independently controllable in 5 ns step<br>4 discrete energy values / 40 μJ (min) to 250 μJ (max) – at 400V amplitude<br>Single / Dual  |
| Energy (Spike Pulse)*:                              | 17 discrete resistances values / 25 Ω min to 1000 Ω max   |
| Modes*:   | 16 discrete inductivity values / 2 μH min to 78 μH max  |
| Damping*:   |   |
| Internal Matching Coil – Probe Impedance Matching*: |   |
| PRF*:   | 0 – optionally; 15...5000 Hz controllable in 1 Hz resolution  |
| Optional Sync Output / Input*:                      | Max +5V, τ ≤ 5 ns, t ≥ 100 ns, Load Impedance ≥ 50 Ω  |
| Gain*:  | 0...120 dB controllable in 0.5 dB resolution  |
| Advanced Low Noise Design*:                         | 93 μV peak to peak input referred to 80 dB gain / 35 MHz bandwidth  |
| Frequency Band*:                                    | 0.35 ... 35 MHz Wide Band / 34 Sub Bands  |
| Ultrasound Velocity*:                               | 300...20000 m/s (11.81...787.4 "/ms) controllable in 1 m/s (0.1 "/ms) resolution  |
| Range*:   | 0.5...7000 μs controllable in 0.01 μs resolution  |
| Display Delay*:                                     | 0...3200 μs controllable in 0.01 μs resolution  |
| Probe Angle*:                                       | 0...90° controllable in 1° resolution   |
| Probe Delay*:                                       | 0 to 70 μs controllable in 0.01 μs resolution - expandable  |
| Display Modes*:                                     | RF, Rectified (Full Wave / Negative or Positive Half Wave), Signal's Spectrum (FFT Graph)   |
| Reject*:  | 0...99 % of screen height controllable in 1% resolution   |
| DAC / TCG*:   | Theoretical – through keying in dB/mm (dB/" ) factor<br>Experimental – through sequential recording echo amplitudes from variously distanced equal reflectors<br>46 dB Dynamic Range, Slope ≤ 20 dB/μs, Capacity ≤ 40 points<br>Available for Rectified and RF Display<br>Standard Library for 18 probes / unlimitedly expandable |
| DGS*:   |   |
| Gates*:   | 2 Independent Gates / unlimitedly expandable  |
| Gate Start and Width*:                              | Controllable over whole variety of A-Scan Display Delay and A-Scan Range in 0.1 mm /// 0.001" resolution<br>5...95 % of A-Scan height controllable in 1 % resolution  |
| Gate Threshold*:                                    |   |
| Measuring Functions – Digital Display Readout*:     | 27 automatic functions / expandable; Dual Ultrasound Velocity Measurement Mode for Multi-Layer Structures; Curved Surface / Thickness / Skip correction for angle beam probes; Ultrasound velocity and Probe Delay Auto-Calibration for all types of probes   |
| Freeze (A-Scans and Spectrum Graphs)*:              | Freeze All – A-Scans and Spectrum Graphs / Freeze Peak – A-Scans / All measurements functions, manipulating Gates, and ±6dB Gain varying are available for frozen signals   |
| Encoder Interface:                                  | Built-in controller and interface for incremental mechanical encoder  |
| Encoding:   | Time-based (built-in real time clock – 0.02 sec resolution) – for single channel operation only<br>True-to-location (incremental encoder – 0.5 mm resolution) – for single and dual channel operation   |
| Imaging Modes:                                      | Single Channel: Thickness Profile B-Scan, Cross-sectional B-Scan, Plane View CB-Scan, TOFD<br>Dual Channel: Thickness Profile B-Scan, Plane View CB-Scan, TOFD  |
| Length of one Straight Line Scanning record:        | 50...20000 mm (2" ...800"), automatic scrolling   |
| Method of Record**:                                 | Complete raw data recording   |
| Region of Interest**:                               | Controllable over entire Display Delay, Probe Delay, Range, Ultrasound Velocity and other appropriate instrument settings   |
| Off-Line Image Analysis**:                          | Recovery and play back of A-Scan sequence at various gain levels<br>Echo-dynamic pattern analysis<br>Defects sizing, outlining, pattern recognition<br>Converting Record into ASCII Format / MS Excel format / MS Word Format   |
| Data Reporting**:                                   | Direct printout of Calibration Dumps, A-Scans, Spectrum Graphs, Thickness Profile B-Scans, cross-sectional B-Scans, plane view CB-Scans, TOFD maps  |
| Data Storage Capacity:                              | At least 100000 sets including calibration dumps accompanied with A-Scans and/or Spectrum Graphs<br>At least 10000 sets including calibration dumps accompanied with Thickness Profile B-Scans, cross-sectional B-Scans, plane view CB-Scans, TOFD maps, and complete sequence of A-Scans captured during scanning                |
| On-Board Computer:                                  | Pentium M 300MHz  |
| RAM:  | 128 Megabytes   |
| Internal Flash Memory - Quasi HDD:                  | 2 Gigabytes   |
| Outputs:  | LAN, USB X 2, PS 2, SVGA  |
| Screen:   | 6.5" High Color Resolution (32 bit) SVGA 640x480 pixels 133x98 mm (5.24" x 3.86") Sun-readable LCD;<br>Maximal A-Scan Size (working area) – 130x92 mm (5.12" x 3.62")   |
| Controls:   | Front Panel Sealed Keyboard, Front Panel Sealed Mouse, Touch Screen   |
| Compatibility with the external devices:            | PS 2 Keyboard and Mouse, USB Keyboard and Mouse, USB Flash Memory card, Printer through USB or LAN, PC through USB or LAN, SVGA External Monitor  |
| Operating System:                                   | Windows™98SE – instrument operation<br>Fully compatible for networking and / or USB connection and off-line data analysis and reporting in external PC running under Windows™98SE, Windows™2000, Windows™XP   |
| Power:  | Mains - 100...240 VAC, 40...70 Hz, auto-switch; Battery 12V 8AH up to 6 hours continuous operation  |

Housing: **IP 53 rugged aluminum case with carrying handle**  
Dimensions: **265×156×121 mm (10.43"×6.14"×4.76") - without battery**  
**265×156×159 mm (10.43"×6.14"×6.26") - with battery**  
Weight: **3.150 kg (5.83 lbs) - without battery**  
**4.280 kg (7.88 lbs) - with battery**

\* - for both channels

\*\* - for single and dual channel operation



## 2.2. Instruments manufactured after Dec 1, 2007

|   |   |
|---|---|
| Pulse Type*:  | Positive Spike Pulse / Positive Square Wave Pulse   |
| Initial Transition*:                                | ≤5 ns (10-90%)  |
| Pulse Amplitude*:                                   | Spike pulse - smoothly tunable (18 levels) 50 V ... 400 V into 50 Ω at 4 levels of excitation Energy<br>Square wave pulse - smoothly tunable (18 levels) 50V ... 400 V into 50 Ω  |
| Pulse Duration*:                                    | Spike pulse - 10...70 ns for 50 Ω load depending on Energy and Damping setup<br>Square wave pulse - 65...600 ns independently controllable in 5 ns step<br>4 discrete energy values / 40 μJ (min) to 250 μJ (max) – at 400V amplitude<br>Single / Dual  |
| Energy (Spike Pulse)*:                              | 17 discrete resistances values / 25 Ω min to 1000 Ω max   |
| Modes*:   | 16 discrete inductivity values / 2 μH min to 78 μH max  |
| Damping*:   |   |
| Internal Matching Coil – Probe Impedance Matching*: |   |
| PRF*:   | 0 – optionally; 15...5000 Hz controllable in 1 Hz resolution  |
| Optional Sync Output / Input*:                      | Max +5V, τ ≤ 5 ns, t ≥ 100 ns, Load Impedance ≥ 50 Ω  |
| Gain*:  | 0...120 dB controllable in 0.5 dB resolution  |
| Advanced Low Noise Design*:                         | 93 μV peak to peak input referred to 80 dB gain / 35 MHz bandwidth  |
| Frequency Band*:                                    | 0.35 ... 35 MHz Wide Band / 34 Sub Bands  |
| Ultrasound Velocity*:                               | 300...20000 m/s (11.81...787.4 "/ms) controllable in 1 m/s (0.1 "/ms) resolution  |
| Range*:   | 0.5...7000 μs controllable in 0.01 μs resolution  |
| Display Delay*:                                     | 0...3200 μs controllable in 0.01 μs resolution  |
| Probe Angle*:                                       | 0...90° controllable in 1° resolution   |
| Probe Delay*:                                       | 0 to 70 μs controllable in 0.01 μs resolution - expandable  |
| Display Modes*:                                     | RF, Rectified (Full Wave / Negative or Positive Half Wave), Signal's Spectrum (FFT Graph)   |
| Reject*:  | 0...99 % of screen height controllable in 1% resolution   |
| DAC / TCG*:   | Theoretical – through keying in dB/mm (dB/" ) factor<br>Experimental – through sequential recording echo amplitudes from variously distanced equal reflectors<br>46 dB Dynamic Range, Slope ≤ 20 dB/μs, Capacity ≤ 40 points<br>Available for Rectified and RF Display<br>Standard Library for 18 probes / unlimitedly expandable |
| DGS*:   |   |
| Gates*:   | 2 Independent Gates / unlimitedly expandable  |
| Gate Start and Width*:                              | Controllable over whole variety of A-Scan Display Delay and A-Scan Range in 0.1 mm /// 0.001" resolution  |
| Gate Threshold*:                                    | 5...95 % of A-Scan height controllable in 1 % resolution  |
| Measuring Functions – Digital Display Readout*:     | 27 automatic functions / expandable; Dual Ultrasound Velocity Measurement Mode for Multi-Layer Structures; Curved Surface / Thickness / Skip correction for angle beam probes; Ultrasound velocity and Probe Delay Auto-Calibration for all types of probes   |
| Freeze (A-Scans and Spectrum Graphs)*:              | Freeze All – A-Scans and Spectrum Graphs / Freeze Peak – A-Scans / All measurements functions, manipulating Gates, and ±6dB Gain varying are available for frozen signals   |
| Encoder Interface:                                  | Built-in controller and interface for incremental mechanical encoder  |
| Encoding:   | Time-based (built-in real time clock – 0.02 sec resolution) – for single channel operation only<br>True-to-location (incremental encoder – 0.5 mm resolution) – for single and dual channel operation   |
| Imaging Modes:                                      | Single Channel: Thickness Profile B-Scan, Cross-sectional B-Scan, Plane View CB-Scan, TOFD<br>Dual Channel: Thickness Profile B-Scan, Plane View CB-Scan, TOFD  |
| Length of one Straight Line Scanning record:        | 50...20000 mm (2" ...800"), automatic scrolling   |
| Method of Record**:                                 | Complete raw data recording   |
| Region of Interest**:                               | Controllable over entire Display Delay, Probe Delay, Range, Ultrasound Velocity and other appropriate instrument settings   |
| Off-Line Image Analysis**:                          | Recovery and play back of A-Scan sequence at various gain levels<br>Echo-dynamic pattern analysis<br>Defects sizing, outlining, pattern recognition<br>Converting Record into ASCII Format / MS Excel format / MS Word Format   |
| Data Reporting**:                                   | Direct printout of Calibration Dumps, A-Scans, Spectrum Graphs, Thickness Profile B-Scans, cross-sectional B-Scans, plane view CB-Scans, TOFD maps  |
| Data Storage Capacity:                              | At least 100000 sets including calibration dumps accompanied with A-Scans and/or Spectrum Graphs<br>At least 10000 sets including calibration dumps accompanied with Thickness Profile B-Scans, cross-sectional B-Scans, plane view CB-Scans, TOFD maps, and complete sequence of A-Scans captured during scanning                |
| On-Board Computer:                                  | Pentium M 300MHz  |
| RAM:  | 1 Gigabyte  |
| Internal Flash Memory - Quasi HDD:                  | 4 Gigabytes   |
| Outputs:  | LAN, USB X 2, PS 2, SVGA  |
| Screen:   | 6.5" High Color Resolution (32 bit) SVGA 640x480 pixels 133x98 mm (5.24" x 3.86") Sun-readable LCD;<br>Maximal A-Scan Size (working area) – 130x92 mm (5.12" x 3.62")   |
| Controls:   | Front Panel Sealed Keyboard, Front Panel Sealed Mouse, Touch Screen   |
| Compatibility with the external devices:            | PS 2 Keyboard and Mouse, USB Keyboard and Mouse, USB Flash Memory card, Printer through USB or LAN, PC through USB or LAN, SVGA External Monitor  |
| Operating System:                                   | Windows™98SE – instrument operation<br>Fully compatible for networking and / or USB connection and off-line data analysis and reporting in external PC running under Windows™98SE, Windows™2000, Windows™XP   |
| Power:  | Mains - 100...240 VAC, 40...70 Hz, auto-switch; Battery 12V 8AH up to 6 hours continuous operation  |

Housing: **IP 53 rugged aluminum case with carrying handle**  
Dimensions: **265×156×121 mm (10.43"×6.14"×4.76") - without battery**  
**265×156×159 mm (10.43"×6.14"×6.26") - with battery**  
Weight: **3.150 kg (5.83 lbs) - without battery**  
**4.280 kg (7.88 lbs) - with battery**

\* - for both channels

\*\* - for single and dual channel operation

## **3. ISONIC 2007 – Scope of Supply**

| # | Item   | Order Code (Part #) | Note |
|---|--|---------------------|------|
| 1 | <p><b>ISONIC 2007 – Dual Channel Portable Digital Ultrasonic Flaw Detector</b></p> <ul style="list-style-type: none"> <li>• <b>ISONIC 2007 Electronic unit</b> – including: <ul style="list-style-type: none"> <li>&gt; Internal PC (P-MMX-S - 300 MHz, RAM-1G, Quazi-HDD Flash Memory Card 4G, active TFT sVGA LCD High Color Sun-Readable Touch Screen, Built-In Interfaces: 2XUSB; Ethernet; PS/2; Front Panel Sealed Keyboard and Mouse; sVGA output)</li> <li>&gt; 100 ... 250 VAC AC/DC converter</li> <li>&gt; SE 248000 - UDS 3-5 Pulsar Receiver Card X 2: <ul style="list-style-type: none"> <li>□ Combined “Spike wave – Selectable Energy” / “Square Wave – Tunable Width” Tunable Firing Level Pulsar; Single / Dual Modes of Operation; Damping: 17 discrete resistances values / 25Ω min to 1000Ω max; Internal Matching Coil – Probe Impedance Matching: 16 discrete inductivity values / 2 μH min to 78 μH max; Special Probe Protection Circuit to Prevent Probe Damage for Not Properly Adjusted Pulse Width</li> <li>□ Gain: 0...120 dB controllable in 0.5 dB resolution; Advanced Low Noise Design: 93μV peak to peak input referred to 80 dB gain / 35 MHz bandwidth; Frequency Band: 0.35 ... 35 MHz Wide Band / 34 Sub Bands</li> <li>□ Built-In Incremental Encoder Interface</li> </ul> </li> </ul> </li> <li>• <b>Software</b> <ul style="list-style-type: none"> <li>□ ISONIC 2006 Multi-Functional Package (SWA 99C07200) <ul style="list-style-type: none"> <li>• <b>Single Channel A-Scan Inspection and Straight Line Scanning Inspection and recording</b> <ul style="list-style-type: none"> <li>◆ <b>A-Scan</b> <ul style="list-style-type: none"> <li>⇒ A-Scan (Full Wave / Neg Wave / Pos Wave rectification; RF)</li> <li>⇒ Selectable A-Scan color scheme</li> <li>⇒ DAC, DGS, TCG</li> <li>⇒ Auto Calibration for Straight Beam and Angle Beam</li> </ul> </li> <li>Probes <ul style="list-style-type: none"> <li>⇒ Curved Surface / Wall Thickness / Skip - Correction for Angle Beam Inspection</li> <li>⇒ Smart Automatic Measurements of Gated Signals - Flank / Flank First / Top / Top First; Auto-Marking Measuring Points on A-Scan</li> <li>⇒ FFT (Frequency Domain Signal Presentation) - additional feature for defects evaluation and / or pattern recognition / probes characterization</li> <li>⇒ Enhanced Signal Evaluation for Live and Frozen A-Scans including Gain Adjustments whilst in Freeze Mode</li> <li>⇒ Dual Ultrasound Velocity Multiecho Measurements</li> </ul> </li> <li>Mode <ul style="list-style-type: none"> <li>⇒ Comprehensive Setup and A-Scan / FFT graph report, Direct Connection To any Type of USB or LAN Windows Printer</li> </ul> </li> <li>◆ <b>Thickness Profile Imaging and Recording (Typical Application: Corrosion characterization)</b> <ul style="list-style-type: none"> <li>⇒ Continuous measuring of thickness value along probe trace</li> <li>⇒ Time-based (real time clock) and true-to-location (built-in incremental encoder interface) modes of data recording</li> <li>⇒ Recording of complete sequence of A-Scans along with thickness profile</li> <li>⇒ Off-line evaluation of thickness profile images featured with: <ul style="list-style-type: none"> <li>▶ Sizing of thickness damages at any location along stored image - remaining thickness, thickness loss, and length of damage</li> <li>▶ Play-back and evaluation of A-Scans obtained during thickness profile recording</li> <li>▶ Echodynamic pattern analysis</li> <li>▶ Off-line reconstruction of thickness profile image for various Gain / Gate setup</li> </ul> </li> <li>⇒ Comprehensive Setup and Scanning Reporting, Direct Connection To any Type of USB or LAN Windows Printer</li> </ul> </li> <li>◆ <b>B-Scan cross-sectional imaging and recording of defects for longitudinal and shear wave inspection (Typical Application: Pulse echo inspection of welds, composites, metals, plastics, and the like)</b> <ul style="list-style-type: none"> <li>⇒ Continuous measuring of echo amplitudes and reflectors coordinates along probe trace</li> <li>⇒ Time-based (real time clock) and true-to-location (built-in incremental encoder interface) modes of data recording</li> </ul> </li> </ul> </li> </ul> </li> </ul> </li> </ul> | SA 80470            |      |

| # | Item   | Order Code (Part #) | Note |
|---|--|---------------------|------|
|   | <ul style="list-style-type: none"> <li>⇒ Recording of complete sequence of A-Scans along with B-Scan defects images</li> <li>⇒ Off-line evaluation of B-Scan record images featured with: <ul style="list-style-type: none"> <li>▶ Sizing of defects at any location along stored image – coordinates and projection size</li> <li>▶ Play-back and evaluation of A-Scans obtained during B-Scan imaging and recording</li> <li>▶ Echodynamic pattern analysis</li> <li>▶ Defects outlining and pattern recognition based on A-Scan sequence analysis</li> <li>▶ Off-line reconstruction of B-Scan defects images for various Gain / Rejection level setup</li> <li>▶ DAC / DGS B-Scan normalization</li> </ul> </li> <li>⇒ Comprehensive Setup and Scanning Reporting, Direct Connection To any Type of USB or LAN Windows Printer</li> <li>◆ <b>CB-Scan horizontal plane-view imaging and recording of defects for shear, surface, and guided wave inspection (Typical Application: Long range pulse echo and CHIME inspection of annular plates and piping, stress corrosion, etc; weld inspection, surface wave inspection)</b> <ul style="list-style-type: none"> <li>⇒ Continuous measuring of echo amplitudes and reflectors coordinates along probe trace</li> <li>⇒ Time-based (real time clock) and true-to-location (built-in incremental encoder interface) modes of data recording</li> <li>⇒ Recording of complete sequence of A-Scans along with CB-Scan defects images</li> <li>⇒ Off-line evaluation of CB-Scan record images featured with: <ul style="list-style-type: none"> <li>▶ Sizing of defects at any location along stored image – coordinates and projection size</li> <li>▶ Play-back and evaluation of A-Scans obtained during CB-Scan imaging and recording</li> <li>▶ Echodynamic pattern analysis</li> <li>▶ Defects outlining and pattern recognition based on A-Scan sequence analysis</li> <li>▶ Off-line reconstruction of CB-Scan defects images for various Gain / Rejection level setup</li> <li>▶ DAC / DGS CB-Scan normalization</li> </ul> </li> <li>⇒ Comprehensive Setup and Scanning Reporting, Direct Connection To any Type of USB or LAN Windows Printer</li> <li>◆ <b>TOFD Inspection – RF B-Scan and D-Scan Imaging (Typical Application: weld inspection; CHIME inspection)</b> <ul style="list-style-type: none"> <li>⇒ Time-based (real time clock) and true-to-location (built-in incremental encoder interface) modes of data recording</li> <li>⇒ Averaging A-Scans whilst recording as per operator's selection</li> <li>⇒ Recording of complete sequence of A-Scans along with TOFD map</li> <li>⇒ Off-line evaluation of TOFD Map featured with: <ul style="list-style-type: none"> <li>▶ Improvement of near to surface resolution through removal of lateral wave and back echo records from TOFD Map</li> <li>▶ Linearization and straightening of TOFD Map</li> <li>▶ Increasing contrast of TOFD images through varying Gain and rectification</li> <li>▶ A-Scan sequence analysis</li> <li>▶ Defects pattern recognition and sizing</li> </ul> </li> <li>⇒ Comprehensive Setup and Scanning Reporting, Direct Connection To any Type of USB or LAN Windows Printer</li> <li>● <b>Dual Channel A-Scan Inspection and Straight Line Scanning Inspection and recording</b> <ul style="list-style-type: none"> <li>◆ <b>A-Scan</b> <ul style="list-style-type: none"> <li>⇒ A-Scan (Full Wave / Neg Wave / Pos Wave rectification; RF)</li> <li>⇒ Selectable A-Scan color scheme</li> <li>⇒ DAC, DGS, TCG</li> </ul> </li> </ul> </li> </ul> </li> </ul> </li></ul> |                     |      |
|   | Probes   |                     |      |

| # | Item  | Order Code (Part #) | Note |
|---|---|---------------------|------|
|   | <ul style="list-style-type: none"> <li>⇒ Curved Surface / Wall Thickness / Skip - Correction for Angle Beam Inspection</li> <li>⇒ Smart Automatic Measurements of Gated Signals - Flank / Flank First / Top / Top First; Auto-Marking Measuring Points on A-Scan</li> <li>⇒ FFT (Frequency Domain Signal Presentation) - additional feature for defects evaluation and / or pattern recognition / probes characterization</li> <li>⇒ Enhanced Signal Evaluation for Live and Frozen A-Scans including Gain Adjustments whilst in Freeze Mode</li> <li>⇒ Dual Ultrasound Velocity Multiecho Measurements Mode</li> <li>⇒ Comprehensive Setup and A-Scan / FFT graph report, Direct Connection To any Type of USB or LAN Windows Printer</li> <li>◆ <b>Dual Channel Thickness Profile Imaging and Recording</b> <ul style="list-style-type: none"> <li>⇒ Continuous measuring of thickness value along probe trace</li> <li>⇒ True-to-location (built-in incremental encoder interface) modes of data recording</li> <li>⇒ Recording of complete sequence of A-Scans along with thickness profile</li> <li>⇒ Off-line evaluation of thickness profile images featured with: <ul style="list-style-type: none"> <li>▶ Sizing of thickness damages at any location along stored image - remaining thickness, thickness loss, and length of damage</li> <li>▶ Play-back and evaluation of A-Scans obtained during thickness profile recording</li> <li>▶ Echodynamic pattern analysis</li> <li>▶ Off-line reconstruction of thickness profile image for various Gain / Gate setup</li> </ul> </li> <li>⇒ Comprehensive Setup and Scanning Reporting, Direct Connection To any Type of USB or LAN Windows Printer</li> <li>◆ <b>Dual Channel CB-Scan horizontal plane-view imaging and recording of defects for shear, surface, and guided wave inspection</b> <ul style="list-style-type: none"> <li>⇒ Continuous measuring of echo amplitudes and reflectors coordinates along probe trace</li> <li>⇒ True-to-location (built-in incremental encoder interface) modes of data recording</li> <li>⇒ Recording of complete sequence of A-Scans along with CB-Scan defects images</li> <li>⇒ Off-line evaluation of CB-Scan record images featured with: <ul style="list-style-type: none"> <li>▶ Sizing of defects at any location along stored image – coordinates and projection size</li> <li>▶ Play-back and evaluation of A-Scans obtained during CB-Scan imaging and recording</li> <li>▶ Echodynamic pattern analysis</li> <li>▶ Defects outlining and pattern recognition based on A-Scan sequence analysis</li> <li>▶ Off-line reconstruction of CB-Scan defects images for various Gain / Rejection level setup</li> <li>▶ DAC / DGS CB-Scan normalization</li> </ul> </li> <li>⇒ Comprehensive Setup and Scanning Reporting, Direct Connection To any Type of USB or LAN Windows Printer</li> <li>◆ <b>Dual Channel TOFD Inspection – RF B-Scan and D-Scan Imaging</b> <ul style="list-style-type: none"> <li>⇒ True-to-location (built-in incremental encoder interface) modes of data recording</li> <li>⇒ Averaging A-Scans whilst recording as per operator's selection</li> <li>⇒ Recording of complete sequence of A-Scans along with TOFD map</li> <li>⇒ Off-line evaluation of TOFD Map featured with: <ul style="list-style-type: none"> <li>▶ Improvement of near to surface resolution through removal of lateral wave and back echo records from TOFD Map</li> <li>▶ Linearization and straightening of TOFD Map</li> </ul> </li> </ul> </li> </ul> </li> </ul> </li></ul> |                     |      |

| #  | Item  | Order Code (Part #) | Note   |
|----|---|---------------------|--|
|    | <ul style="list-style-type: none"> <li>▶ Increasing contrast of TOFD images through varying Gain and rectification</li> <li>▶ A-Scan sequence analysis</li> <li>▶ Defects pattern recognition and sizing</li> </ul> <p>⇒ Comprehensive Setup and Scanning Reporting, Direct Connection To any Type of USB or LAN Windows Printer</p> <ul style="list-style-type: none"> <li>• <b><u>USB Flash Drive for External Data Storage</u></b></li> <li>• <b><u>12 months warranty</u></b></li> <li>• <b><u>Lifetime free software update</u></b></li> </ul> |                     |  |
| 2  | Backup Pen-drive  | SFD 2007098         | Operating Manual on the Pen-Drive  |
| 3  | Silicon Rubber Jacket   | SK 2007111          | Optional item  |
| 4  | Rechargeable Battery Ni MH 9 AH / 12V   | SK 2005102          | Optional item  |
| 5  | Battery Charger   | SK 2005103          | Optional item<br>Required for battery charge   |
| 6  | Travel Hard Case  | SK 2005104          | Optional item<br>Allows safe cargo transportation  |
| 7  | External USB Keyboard   | SK 2005105          | Optional Item<br>Extremely Useful at Postprocessing Stage  |
| 8  | External USB Optical Mouse  | SK 2005106          | Optional Item<br>Extremely Useful at Postprocessing Stage  |
| 9  | <p><b><u>Postprocessing SW Package for Office PC: IOFFICE - ISONIC Office</u></b></p> <p>⇒ comprehensive postprocessing of inspection results files captured by ISONIC 2001, ISONIC 2005, ISONIC 2006, ISONIC 2007, ISONIC 2008</p> <p>⇒ automatic creating of ISONIC 2001, ISONIC 2005, ISONIC 2006, ISONIC 2007, ISONIC 2008 inspection reports in MS Word® format</p>  | SWA99C0203          | Optional   |
| 10 | <p>Dual Channel TOFD preamplifier package including:</p> <p>⇒ Dual Channel TOFD preamplifier</p> <p>⇒ Set of 2 low noise coaxial cables (10 meters length each) for connection to the signal input of ISONIC instrument</p>   | SA 80442            | Optional Item<br>Improves long cable connection to ultrasonic probes. Typical applications are TOFD, Corrosion Detection, etc performed with probes fitted into scanner / crawler frame – refer to chapter 10 of this Operating Manual |
| 11 | <p>ISONIC Alarmer - standard firmware configuration and hardware platform including:</p> <p>⇒ Internal Speaker functioning according to alarm logic settings of UDS 3-5 Pulsar Receiver in the ISONIC 2005, 2006, 2007 instruments / UDS 3-6 Pulsar Receiver of ISONIC 2008 Instrument</p> <p>⇒ Speaker Volume Control Wheel</p> <p>⇒ Headphone Connector</p> <p>⇒ 25-pin programmable Input / Output interface (blank)</p> <p>⇒ USB port and cable for connecting to ISONIC 2005, 2006, 2007, 2008 instrument</p>                                  | SE 554780987        | Optional Item<br>Refer to paragraph 8.8.5 of this Operating Manual   |
| 12 | Ultrasonic probes, fixtures, scanners, cables and other accessories depending on the inspection tasks to be resolved  |                     | Optional Items<br>Ultrasonic probes, fixtures, scanners, cables and other accessories from any manufacturer may be used  |

## 4. Operating ISONIC 2007



Please read the following information before you use **ISONIC 2007**. It is essential to read and understand the following information so that no errors occur during operation, which could lead damaging of the unit or misinterpretation of inspection results

## **4.1. Preconditions for ultrasonic testing with ISONIC 2007**

Operator of **ISONIC 2007** must be certified as at least *Level 2 Ultrasonic Examiner* additionally having the adequate knowledge of

- operating digital ultrasonic flaw detector
- basics of computer operating in the **Windows™** environment including turning computer on/off, keyboard, touch screen and mouse, starting programs, saving and opening files

## 4.2. ISONIC 2007 Controls and Terminals

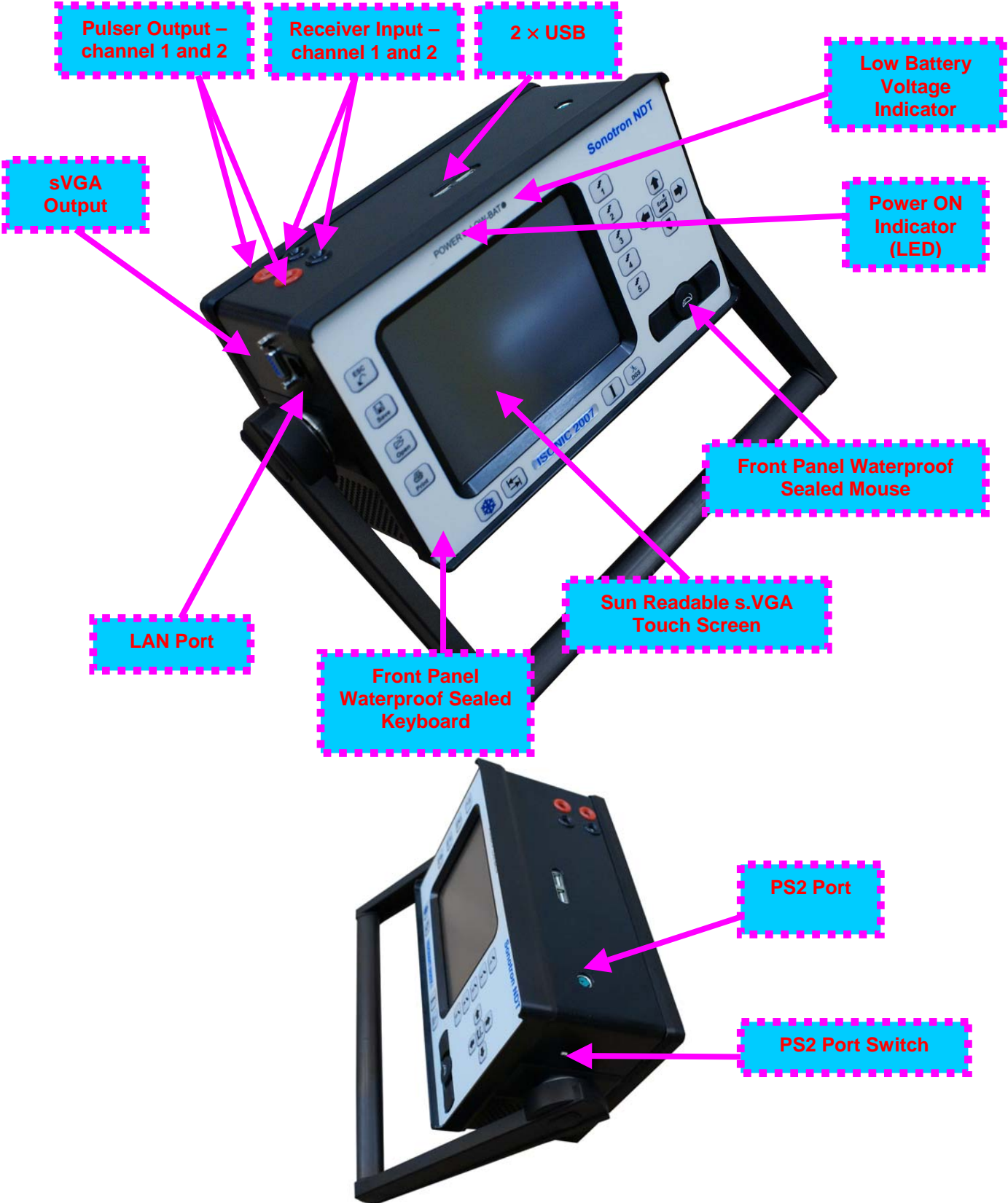

PS 2 Port Switch has 2 positions:  
 Front – Front Panel Keyboard and Mouse active; PS2 Port inactive  
 Rear – Front Panel Keyboard and Mouse inactive; PS2 Port active

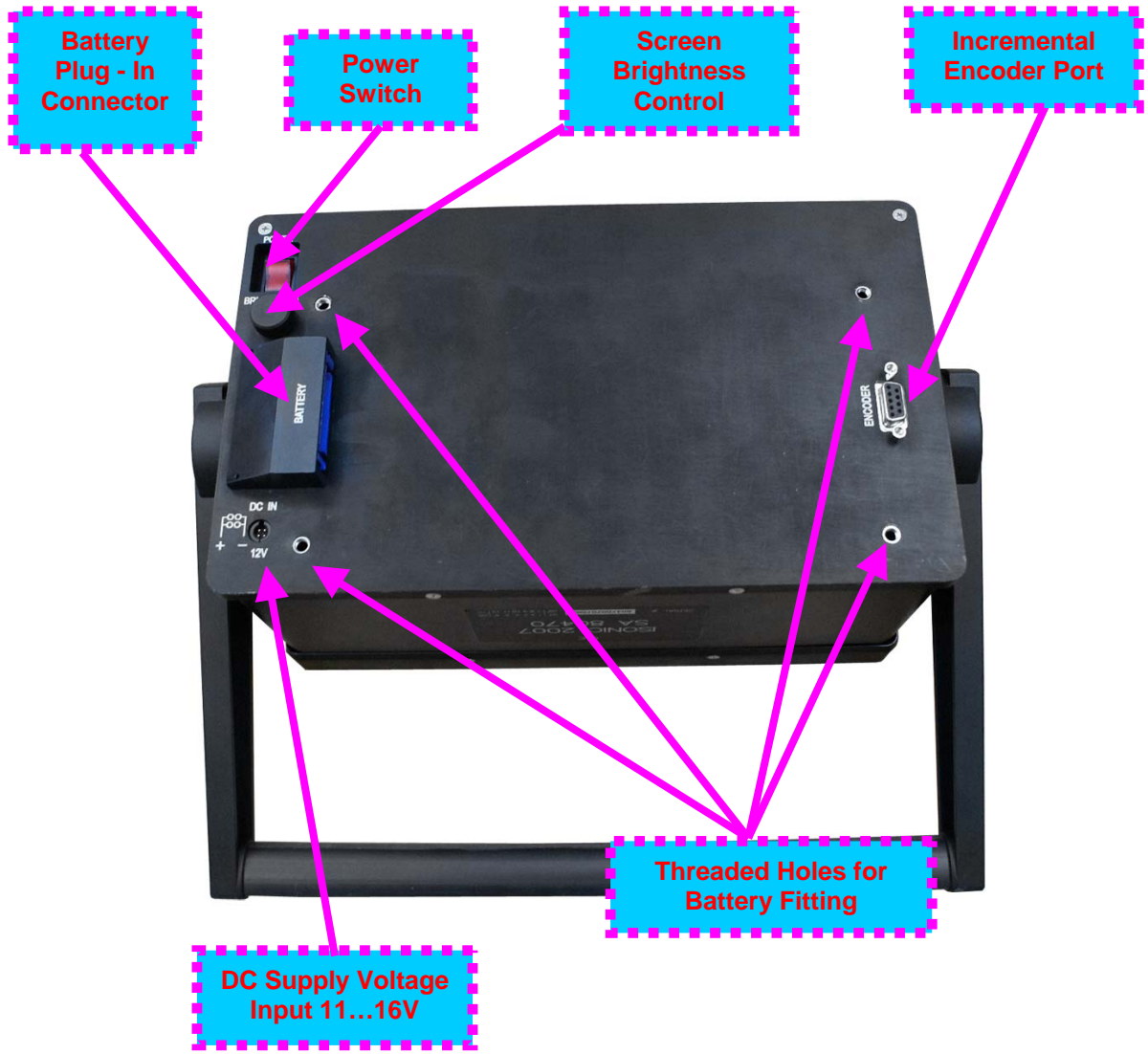

## 4.3. Turning On / Off

ISONIC 2007 may be powered from:

- 100...250 VAC through external AC/DC converter
- External 11...16V DC source (12V – typical)
- Rechargeable battery (optionally)

### AC Power Supply

- ❑ Ensure that power switch is in **O** position before connecting power cords
- ❑ Connect one end of AC power cord to AC/DC converter and plug another end into AC mains
- ❑ Connect DC power cord with suppression filter outgoing from AC/DC converter to DC Supply Voltage Input of **ISONIC 2007**

### External DC Power Supply



- ❑ Ensure DC mains do supply voltage between 11 V and 16 V
- ❑ Ensure that power switch is in **O** position before connecting power cord
- ❑ Connect one end of DC power cord with suppression filter to DC Supply Voltage Input of **ISONIC 2007** and plug another end into DC mains

### Battery

- ❑ Ensure that power switch is in **O** position
- ❑ Plug in battery and fix it using 4 screws



### Power-Up and Turn Off



To Power-Up **ISONIC 2007** set power switch into **I** position. An automatic system test program will then be executed; during this test various texts and information appear followed by the screen as below while booting up



| Instruments manufactured on or before Dec 1, 2007                                   | Instruments manufactured after Dec 1, 2007   |
|---|--|
|  |  |



Wait until **ISONIC 2007 start screen** becomes active automatically upon boot up is completed





Click on  or press  on front panel keyboard or press **F1** on external keyboard to operate **ISONIC 2007** – refer to Chapters 5 through 7 of this Operating Manual

Click on  or press  on front panel keyboard or press **F2** on external keyboard to proceed with general settings of **ISONIC 2007** – refer to Chapters 8 and 9 of this Operating Manual

Click on  or press  on front panel keyboard or press **F3** on external keyboard if it is necessary to fulfill some general purpose Windows procedures such as setting up drivers for external devices (printers, USB memory card, and the like), connecting to LAN, quasi-disk management, etc – refer to Chapter 8 of this Operating Manual

To turn **ISONIC 2007** off click on  or press on  on front panel keyboard or press **F4** on external keyboard then wait until the screen as below appears:

| Instruments manufactured on or before Dec 1, 2007                                  | Instruments manufactured after Dec 1, 2007  |
|--|---|
|  |  |

Set power switch into **O** position upon



After turning **ISONIC 2007 OFF** wait at least 10...30 seconds before switching it **ON** again

## **5. UDS 3-5 Pulsar Receiver Channels**

## 5.1. Start Up UDS 3-5 Pulsar Receiver

While **ISONIC 2007 start screen** is active click on  or press  on the front panel

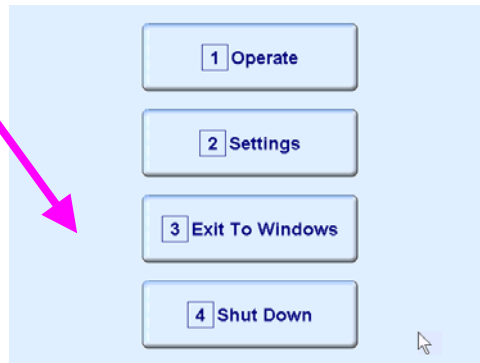

keyboard or press **F1** on external keyboard

## 5.2. Main Operating Surface

Both UDS 3-5 pulser receiver channels of ISONIC 2007 instrument are fully controllable through identical main operating surface:

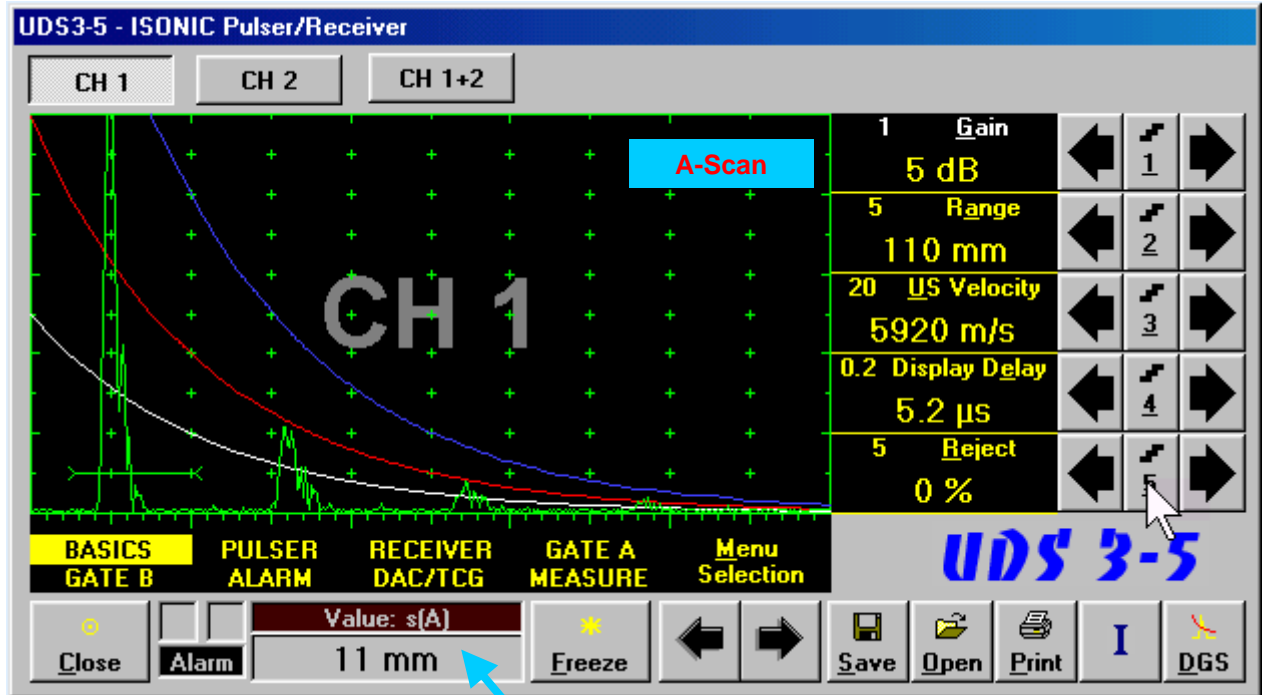

Value Box - Digital Readout

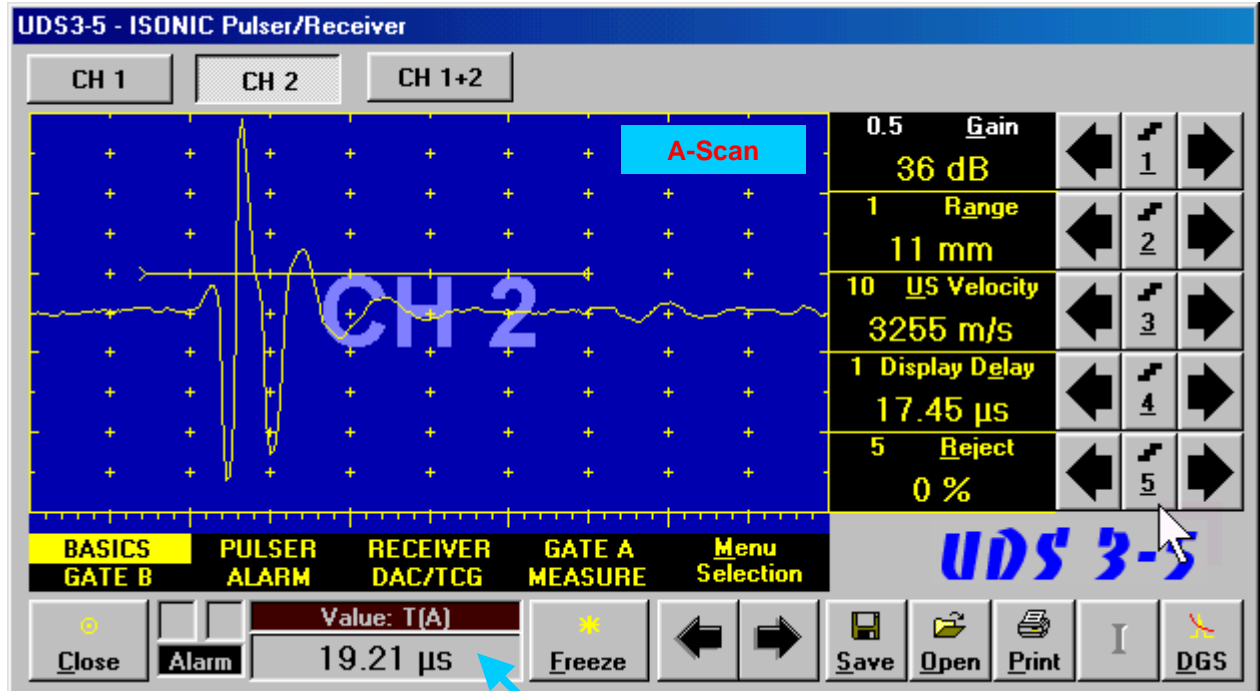

Value Box - Digital Readout

To switch between Channels (CH) 1 and 2 click on **CH 1** and **CH 2** correspondingly



Clicking on **CH 1+2** allows monitoring of both A-Scans obtained by CH 1 and CH 2 simultaneously:

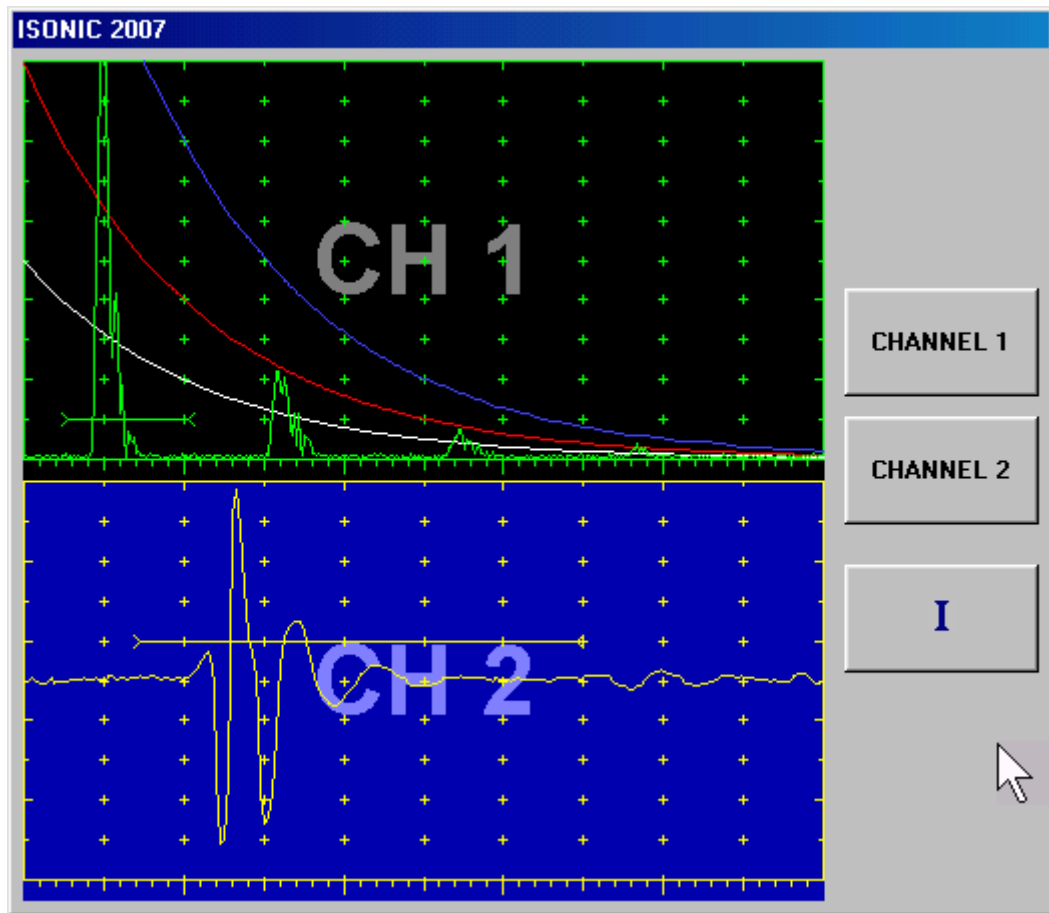

Click on **CHANNEL 1** or press **1** on the front panel keyboard or **F1** on external keyboard to return to control of CH 1

Click on **CHANNEL 2** or press **2** on the front panel keyboard or **F2** on external keyboard to return to control of CH 2

Click on **I** or press **I** on the front panel keyboard or **F8** on external keyboard to proceed with dual channel scanning, recording, and imaging – refer to paragraph 7.1 of present Operating Manual

## 5.2.1. Main Menu

**Main Menu** consists of eight topics; each topic is associated with corresponding **submenu** appearing as vertical bar showing names for five parameters or modes of operation, their current settings and current value of increment/decrement for a parameter. The active topic is highlighted

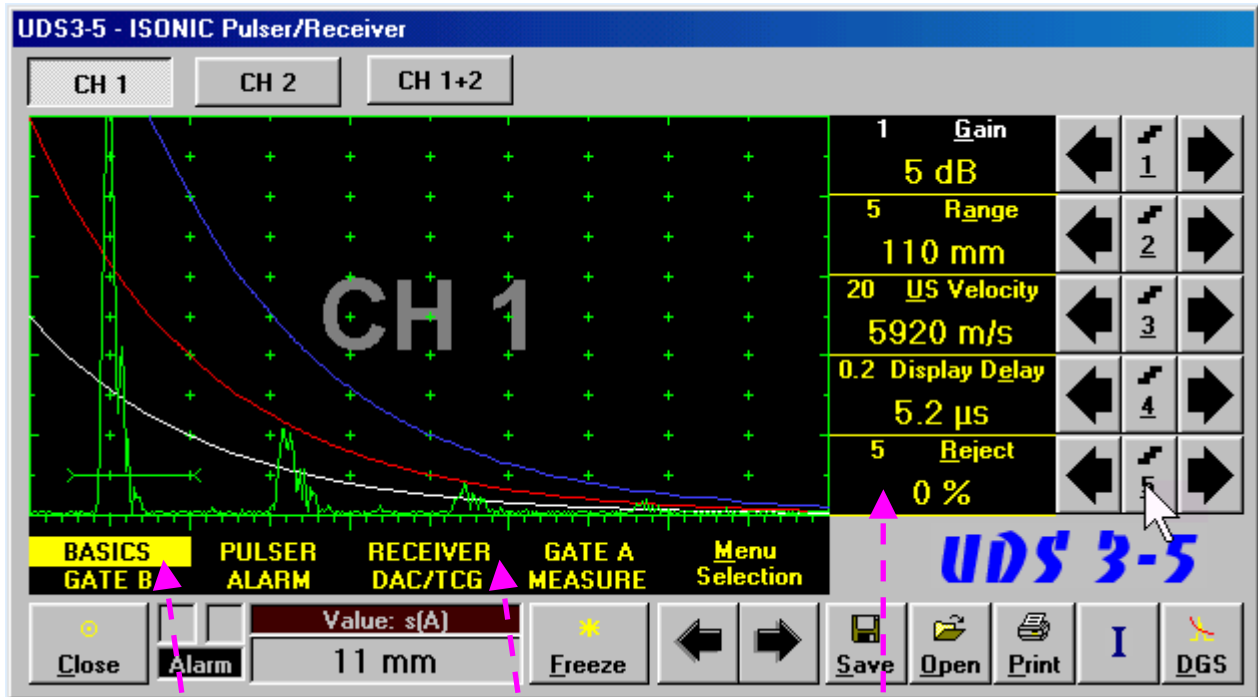





Active Topic

Main Menu

Vertical bar – Submenu corresponding to highlighted active topic

To activate a topic the following manipulations are applicable:

- **Keyboard**









- Press  on front panel keyboard or **F7** on external keyboard until highlighting required topic OR
- Press **<Alt>+<M>** on external keyboard ⇒ **Menu Selection** fore color changes to white - then use , , , 

- **Mouse / Touch Screen**

- Click on topic's name OR

- Click on  

- **Combined**

- Click on **Menu Selection** ⇒ **Menu Selection** fore color changes to white - then use , , ,  on front panel keyboard or , , ,  on external keyboard

## 5.2.2. Sub Menu BASICS

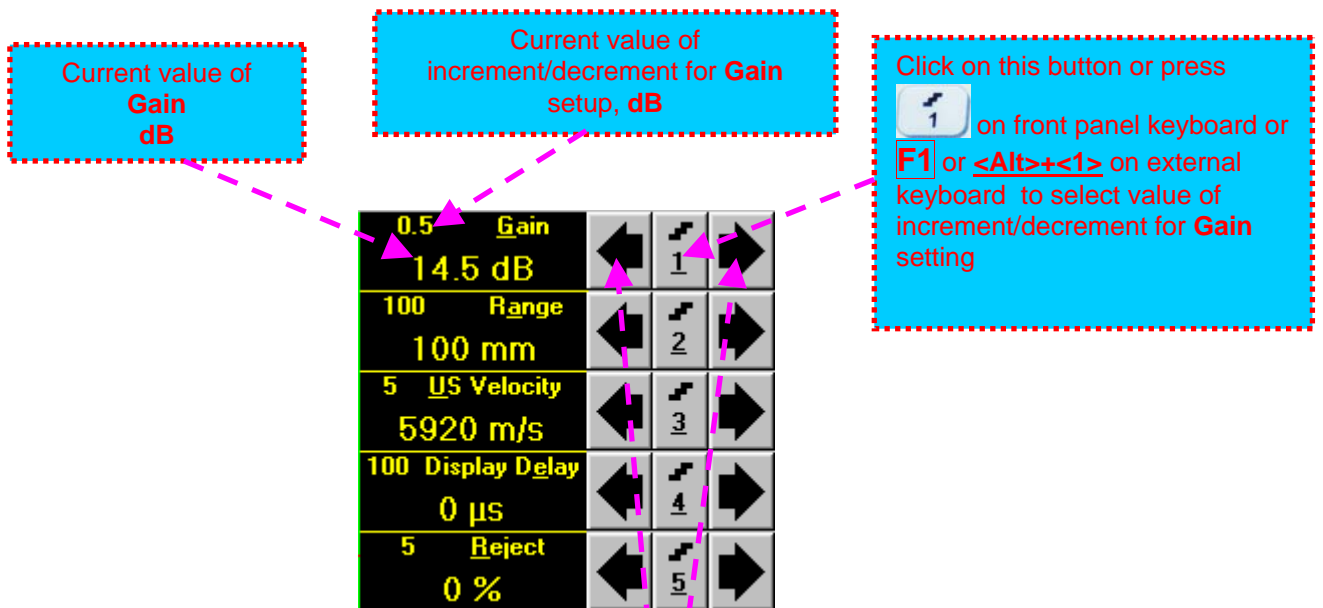









To control **Gain** the following manipulations are applicable:









- **Mouse / Touch Screen**

- Click or press and hold on the appropriate button

- **Keyboard**

- Press  on front panel keyboard or **F1** or **<Alt>+<G>** on external keyboard ⇒ **G**ain fore color changes to white - then use , , ,  on front panel keyboard or , , ,  on external keyboard

- **Combined**

- Click on **G**ain ⇒ **G**ain fore color changes to white - then use , , ,  on front panel keyboard or , , ,  on external keyboard



**Gain** setup is also possible through a number of other submenus following the same rules as above

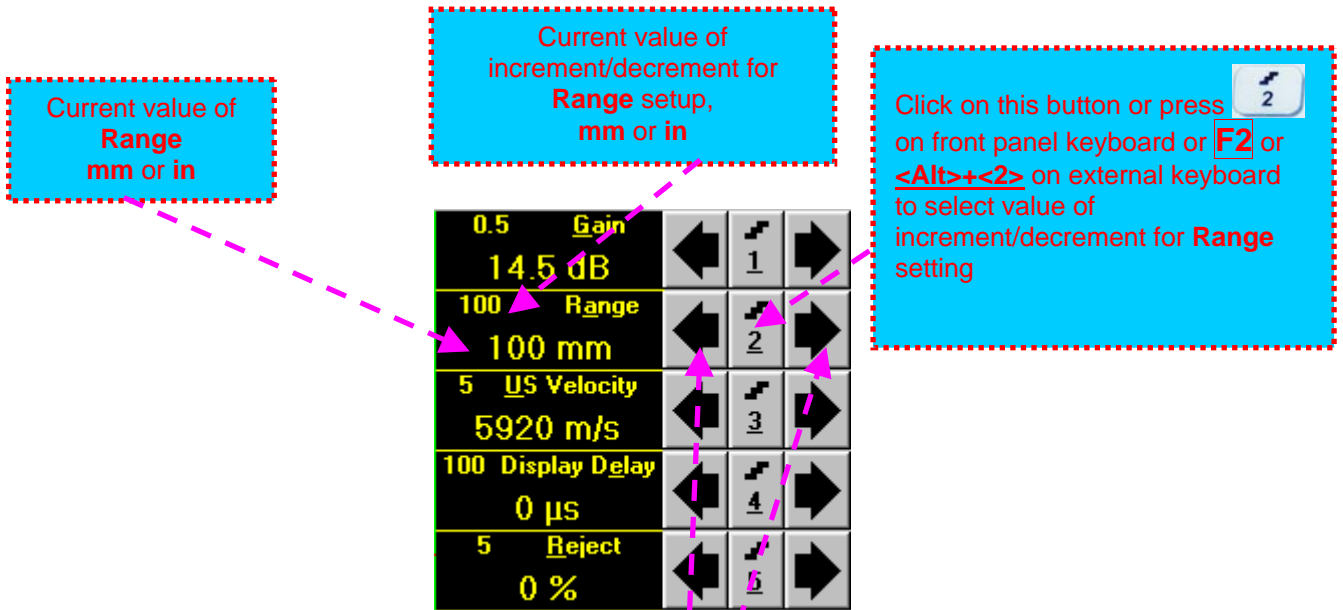









To control **Range** the following manipulations are applicable:









- **Mouse / Touch Screen**

- Click or press and hold on the appropriate **button**

- **Keyboard**

- Press  on front panel keyboard or **F2** or **<Alt>+<A>** on external keyboard ⇒ **Range** fore color changes to white - then use , , ,  on front panel keyboard or , , ,  on external keyboard

- **Combined**

- Click on **Range** ⇒ **Range** fore color changes to white - then use , , ,  on front panel keyboard or , , ,  on external keyboard



**Range** setup is also possible through a number of other submenus following the same rules as above

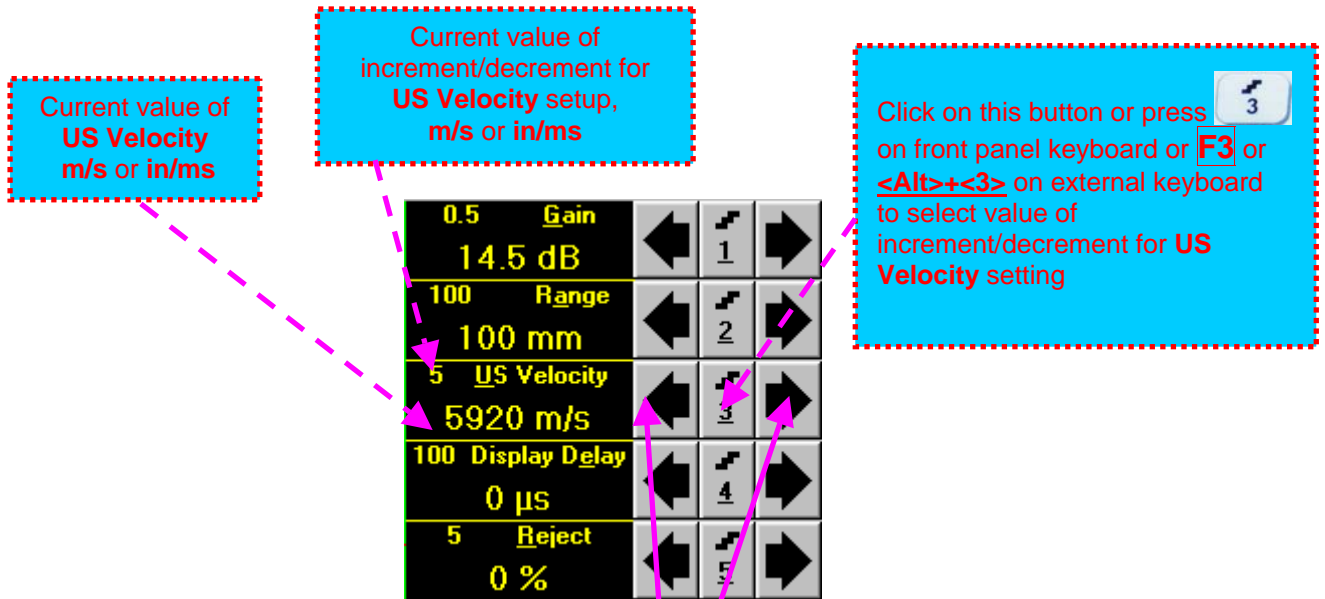

To control **US Velocity** the following manipulations are applicable:

- **Mouse / Touch Screen**

- Click or press and hold on the appropriate **button**

- **Keyboard**

- Press on front panel keyboard or **F3** or **<Alt>+<U>** on external keyboard ⇒ **US Velocity** fore color changes to white - then use , , , on front panel keyboard or , , , on external keyboard

- **Combined**

- Click on **US Velocity** ⇒ **US Velocity** fore color changes to white - then use , , , on front panel keyboard or , , , on external keyboard

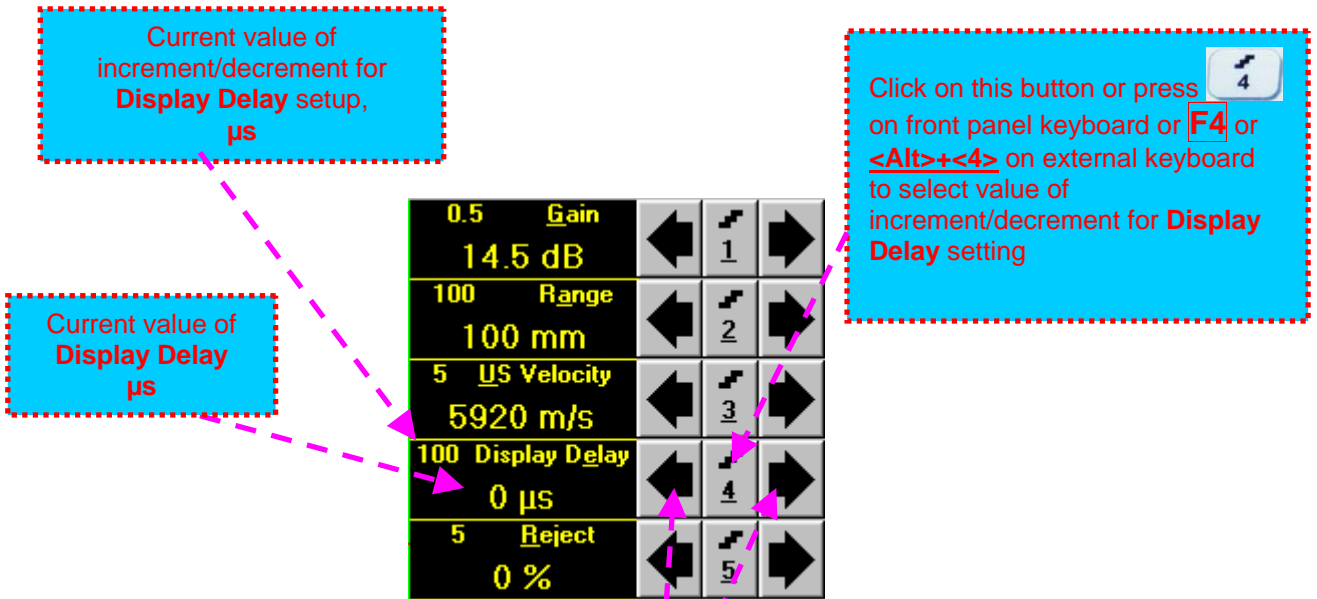









To control **Display Delay** the following manipulations are applicable:









- **Mouse / Touch Screen**

- Click or press and hold on the appropriate button

- **Keyboard**

- Press  on front panel keyboard or **F4** or **<Alt>+<E>** on external keyboard  $\Rightarrow$  **Display Delay** fore color changes to white - then use , , ,  on front panel keyboard or , , ,  on external keyboard

- **Combined**

- Click on **Display Delay**  $\Rightarrow$  **Display Delay** fore color changes to white - then use , , ,  on front panel keyboard or , , ,  on external keyboard

















Current value of increment/decrement for **Reject** setup, %

Current value of **Reject** %

|      |               |   |   |   |
|------|---------------|---|---|---|
| 0.5  | Gain          | ← | 1 | → |
| 14.5 | dB            | ← | 2 | → |
| 100  | Range         | ← | 3 | → |
| 100  | mm            | ← | 4 | → |
| 5    | US Velocity   | ← | 5 | → |
| 5920 | m/s           | ← |   | → |
| 100  | Display Delay | ← |   | → |
| 0    | μs            | ← |   | → |
| 5    | Reject        | ← |   | → |
| 0    | %             | ← |   | → |

Click on this button or press  on front panel keyboard or **F5** or **<Alt>+<5>** on external keyboard to select value of increment/decrement for **Reject** setting

To control **Reject** the following manipulations are applicable:

- **Mouse / Touch Screen**
  - Click or press and hold on the appropriate **button**
- **Keyboard**
  - Press  on front panel keyboard or **F5** or **<Alt>+<E>** on external keyboard ⇒ **Reject** fore color changes to white - then use , , ,  on front panel keyboard or , , ,  on external keyboard
- **Combined**
  - Click on **Reject** ⇒ **Reject** fore color changes to white - then use , , ,  on front panel keyboard or , , ,  on external keyboard



- ◆ Signals below **Reject** level (small signals) are suppressed
- ◆ Signals exceeding **Reject** level (large signals) are presented on the A-Scan without affecting their original height
- ◆ Part of large signal wave form below **Reject** level is suppressed

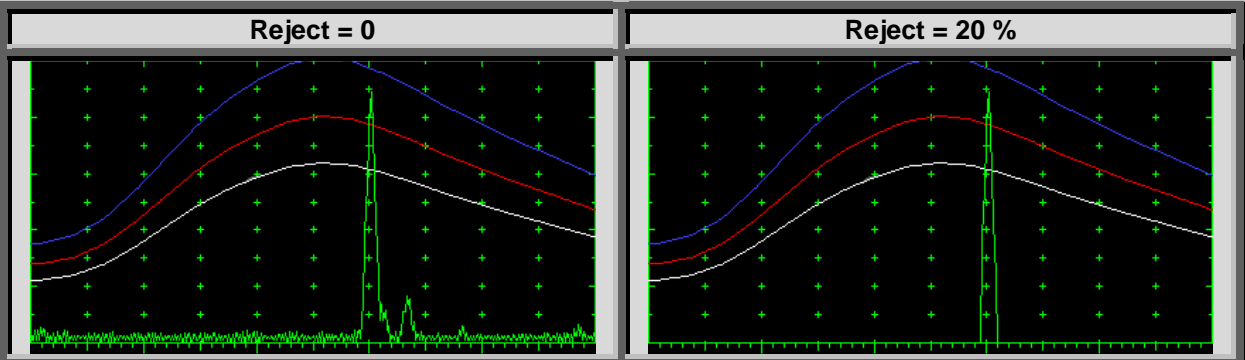

- ◆ **Reject** level may be applied to rectified signals only (Display Modes **Full**, **NegHalf** and **PosHalf** - refer to paragraph 5.2.4 of this Operating Manual)
- ◆ **Reject** setup is also possible through a number of other submenus following the same rules as above

### 5.2.3. Sub Menu PULSER

Amplitude of initial pulse (Firing Level) is controllable through button  appearing on the main operating surface upon activating submenu **PULSER**

To activate **Firing Level Control** subwindow click on 

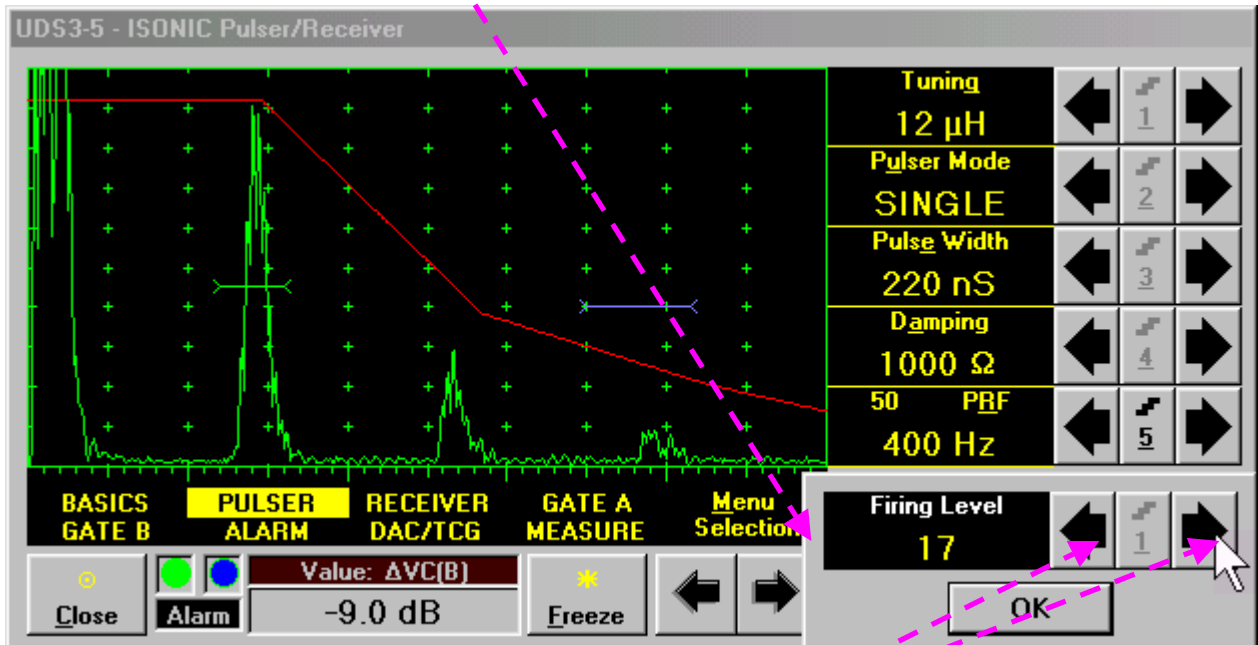











To control **Firing Level** the following manipulations are applicable:

- **Mouse / Touch Screen**

- Click or press and hold on the appropriate **button** Click on  or on any control outside **Firing Level Control** popup window upon completing

- **Combined**

Click on **Firing Level** ⇒ **Firing Level** fore color changes to white - then use , , ,  on front panel keyboard or , , ,  on external keyboard. Press  or  on front panel keyboard or **Esc** or **Enter** on an external keyboard upon completing



There are 18 grades (1 through 18) for setting **Firing Level** – amplitude of initial pulse is controlled from 50 V (**Firing Level** = 1) to 400 V (**Firing Level** = 18)



Current value of  
**Tuning**  
 $\mu\text{H}$

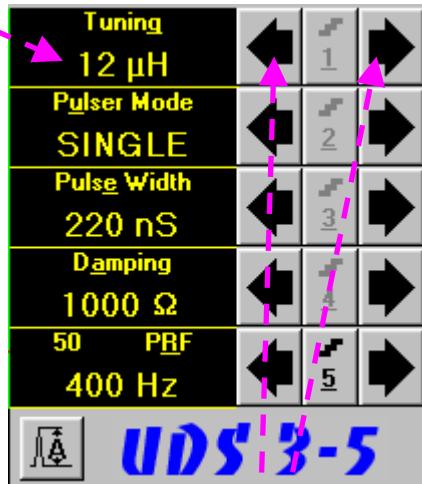





To control **Tuning** the following manipulations are applicable:





- **Mouse / Touch Screen**

- Click or press and hold on the appropriate button

- **Keyboard**

- Press  on front panel keyboard or **F1** or **<Alt>+<G>** on external keyboard  $\Rightarrow$  **Tuning** fore color changes to white - then use , , ,  on front panel keyboard or  $\uparrow$ ,  $\rightarrow$ ,  $\leftarrow$ ,  $\downarrow$  on external keyboard

- **Combined**

- Click on **Tuning**  $\Rightarrow$  **Tuning** fore color changes to white - then use , , ,  on front panel keyboard or  $\uparrow$ ,  $\rightarrow$ ,  $\leftarrow$ ,  $\downarrow$  on external keyboard



- ◆ There are 16 (sixteen) matching coils, which may be connected at parallel to ultrasonic probe in order to obtain best available probe impedance matching / signal to noise ratio. Possible values for the matching coil inductance are:  $2\mu\text{H}$ ,  $7\mu\text{H}$ ,  $12\mu\text{H}$ ,  $17\mu\text{H}$ ,  $24\mu\text{H}$ ,  $29\mu\text{H}$ ,  $34\mu\text{H}$ ,  $39\mu\text{H}$ ,  $41\mu\text{H}$ ,  $46\mu\text{H}$ ,  $51\mu\text{H}$ ,  $56\mu\text{H}$ ,  $63\mu\text{H}$ ,  $68\mu\text{H}$ ,  $73\mu\text{H}$ , and  $78\mu\text{H}$
- ◆ Setting the **Tuning** to "NO" disconnects matching coil

Current **Pulser Mode**

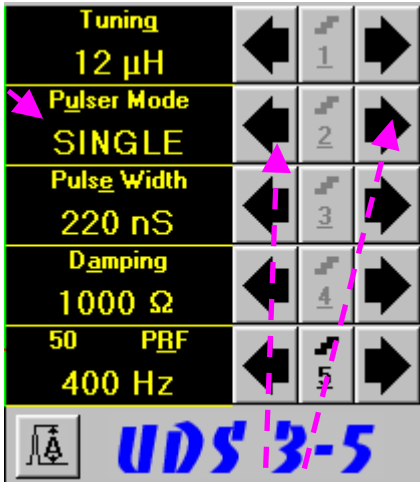









To control **Pulser Mode** the following manipulations are applicable:









- **Mouse / Touch Screen**

- Click or press and hold on the appropriate **button**

- **Keyboard**

- Press  on front panel keyboard or **F2** or **<Alt>+<U>** on external keyboard ⇒ **Pulser Mode** fore color changes to white - then use , , ,  on front panel keyboard or , , ,  on external keyboard

- **Combined**

- Click on **Pulser Mode** ⇒ **Pulser Mode** fore color changes to white - then use , , ,  on front panel keyboard or , , ,  on external keyboard

 There are two Pulser Modes available: **Single** and **Dual**

Current value of **Pulse Width**  
(Duration of Square Wave  
Initial Pulse)  
**ns**

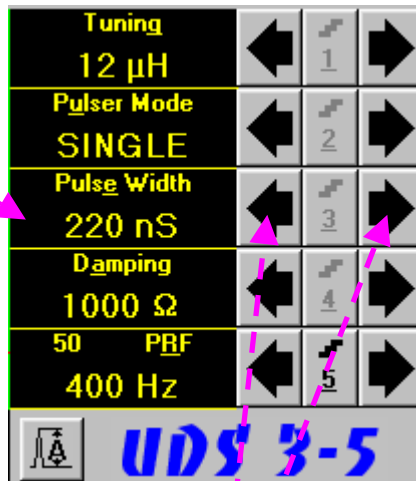









To control **Pulse Width** the following manipulations are applicable:









- **Mouse / Touch Screen**

- Click or press and hold on the appropriate **button**

- **Keyboard**

- Press  on front panel keyboard or **F3** or **<Alt>+<E>** on external keyboard ⇒ **Pulse Width** fore color changes to white - then use , , ,  on front panel keyboard or , , ,  on external keyboard

- **Combined**

- Click on **Pulse Width** ⇒ **Pulse Width** fore color changes to white - then use , , ,  on front panel keyboard or , , ,  on external keyboard



- ◆ **Pulse Width** (Duration of Square Wave Initial Pulse) is tunable between 65 ns to 600 ns in 5 ns steps
- ◆ Attempt to decrease **Pulse Width** below 65 ns switches to *excitation of Spike Pulse instead of Square Wave Pulse*. There are 4 (four) energy levels available for the **Spike Pulse** excitation; said levels are indicated in the **Pulse Width** field:
  - **Spike (250μJ)** – spike pulse with the 250 μJ energy of excitation
  - **Spike (160μJ)** – spike pulse with the 160 μJ energy of excitation
  - **Spike (90μJ)** – spike pulse with the 90 μJ energy of excitation
  - **Spike (40μJ)** – spike pulse with the 40 μJ energy of excitation
- ◆ The energy of **Spike Pulse** excitation is controllable through the same controls as **Pulse Width**
- ◆ Attempt to increase energy of **Spike Pulse** excitation above 250 μJ switches to *excitation of Square Wave Pulse instead of Spike Pulse*
- ◆ Energy levels of **Spike Pulse** excitation are calibrated at **Firing Level = 18**

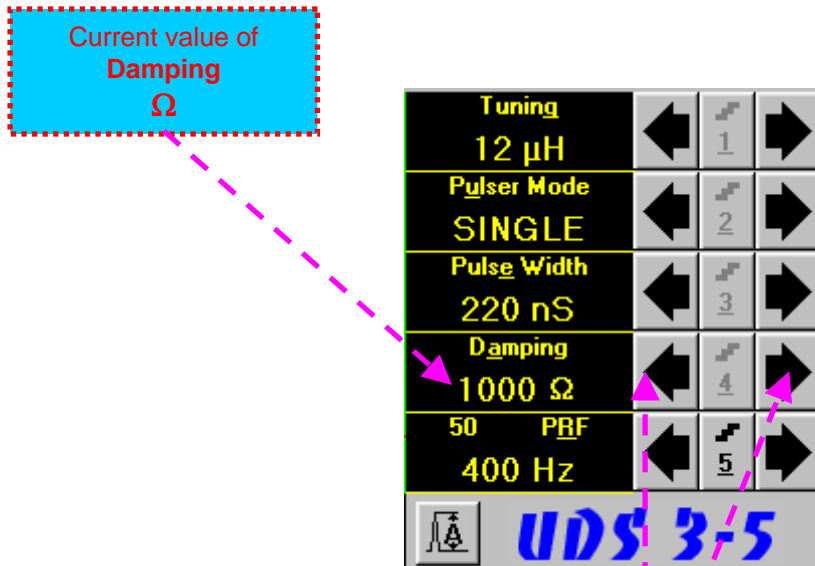









To control **Damping** the following manipulations are applicable:









- **Mouse / Touch Screen**

- Click or press and hold on the appropriate **button**

- **Keyboard**

- Press  on front panel keyboard or **F4** or **<Alt>+<A>** on external keyboard ⇒ **Damping** fore color changes to white - then use , , ,  on front panel keyboard or , , ,  on external keyboard

- **Combined**

- Click on **Damping** ⇒ **Damping** fore color changes to white - then use , , ,  on front panel keyboard or , , ,  on external keyboard



There are 17 (seventeen) discrete damping resistors, which may be connected at parallel to ultrasonic probe, their resistance values are 25Ω, 30Ω, 35Ω, 40Ω, 45Ω, 56Ω, 65Ω, 76Ω, 90Ω, 115Ω, 130Ω, 150Ω, 180Ω, 240Ω, 320Ω, 500Ω, and 1000 Ω

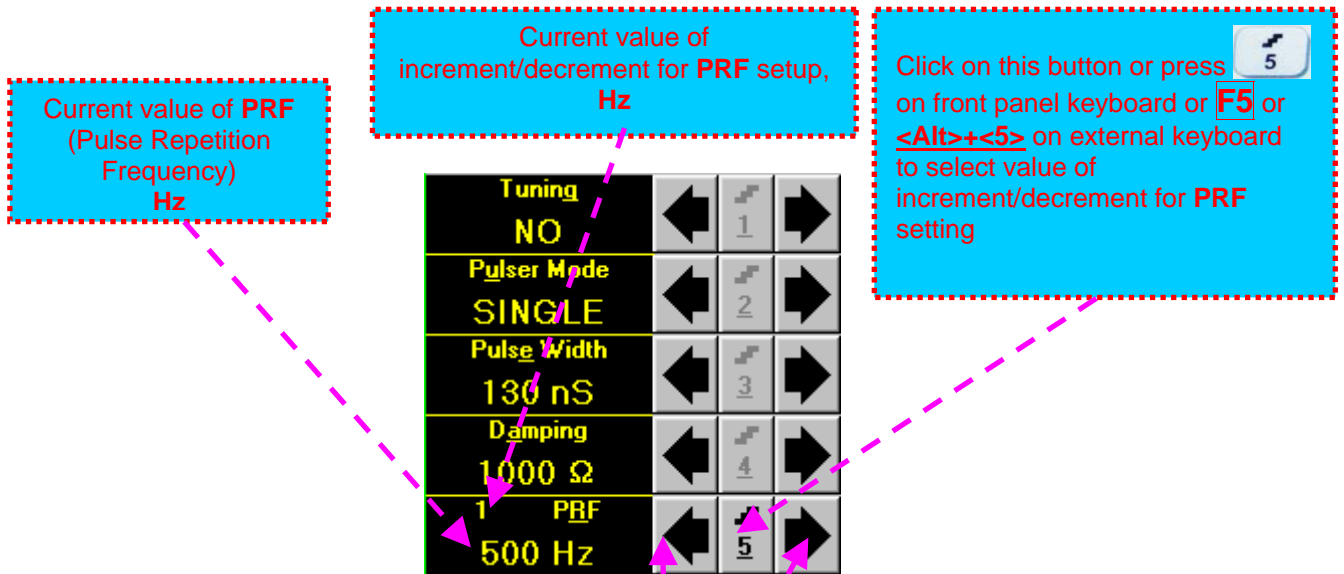

To control **PRF** the following manipulations are applicable:

- **Mouse / Touch Screen**

- Click or press and hold on the appropriate **button**

- **Keyboard**

- Press on front panel keyboard or **F5** or **<Alt>+<R>** on external keyboard ⇒ **PRF** fore color changes to white - then use , , , on front panel keyboard or , , , on external keyboard

- **Combined**

- Click on **PRF** ⇒ **PRF** fore color changes to white - then use , , , on front panel keyboard or , , , on external keyboard



**UDS 3-5** is equipped with a protection circuit preventing probe damage, which may be caused by not proper setting of **Tuning**, or **Damping**, or **Pulse Width**, or **Firing Level**, or combination of them. Protection circuit limits total energy delivered to firing output through *automatic reducing of PRF until reaching safe mode of operation*

## 5.2.4. Sub Menu RECEIVER

Current setting of **Filter** representing central frequency of the narrow band (resonant) Filter  
MHz

|           |         |   |   |   |
|-----------|---------|---|---|---|
| 0.5       | Gain    | ← | 1 | → |
| 11        | dB      | ← | 2 | → |
| Filter    | BB      | ← | 3 | → |
| Frequency | 0.35-35 | ← | 4 | → |
| Display   | Full    | ← | 5 | → |
| 5         | Reject  | ← |   | → |
| 0         | %       | ← |   | → |

To control **Filter** the following manipulations are applicable:

- **Mouse / Touch Screen**

- Click or press and hold on the appropriate **button**

- **Keyboard**

- Press **2** on front panel keyboard or **F2** or **<Alt>+<L>** on external keyboard ⇒ **Filter** fore color changes to white - then use **↑**, **→**, **←**, **↓** on front panel keyboard or **↑**, **→**, **←**, **↓** on external keyboard

- **Combined**

- Click on **Filter** ⇒ **Filter** fore color changes to white - then use **↑**, **→**, **←**, **↓** on front panel keyboard or **↑**, **→**, **←**, **↓** on external keyboard



- ◆ The are 6 (six) narrow bands (resonant) filters with central frequencies as below:
  - **0.5 ± 0.15 MHz** – recommended for 0.3 ... 0.8 MHz probes
  - **1 ± 0.3 MHz** – recommended for 0.8 ... 1.5 MHz probes
  - **2 ± 0.6 MHz** – recommended for 1.5 ... 3.2 MHz probes
  - **4 ± 1.2 MHz** – recommended for 3.2 ... 7.5 MHz probes
  - **10 ± 3 MHz** – recommended for 7.5 ... 12.4 MHz probes
  - **15 ± 4.5 MHz** – recommended for 12.4 ... 17 MHz probes
- ◆ The narrow band (resonant) filtering is negated upon setting **Filter** to **BB** (Broad Band)

Current **Frequency** band of the receiver  
**MHz**  
**From – To**

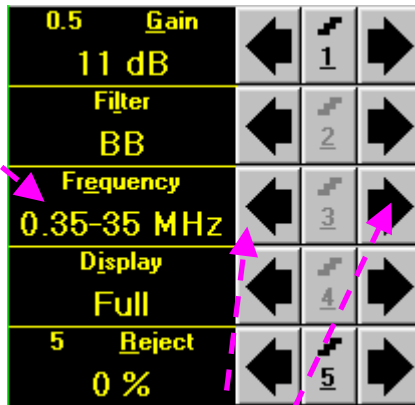









To control receiver's **Frequency** band the following manipulations are applicable:









- **Mouse / Touch Screen**

- Click or press and hold on the appropriate **button**

- **Keyboard**

- Press  on front panel keyboard or **F3** or **<Alt>+<E>** on external keyboard ⇒ **Frequency** fore color changes to white - then use , , ,  on front panel keyboard or , , ,  on external keyboard

- **Combined**

- Click on **Frequency** ⇒ **Frequency** fore color changes to white - then use , , ,  on front panel keyboard or , , ,  on external keyboard



There are 28 (twenty eight) receiver's **Frequency** bands:

|               |                 |               |                |                |                |                 |
|---------------|-----------------|---------------|----------------|----------------|----------------|-----------------|
| 0.35 – 35 MHz | 0.35 – 19.5 MHz | 0.35 – 13 MHz | 0.35 – 5.2 MHz | 0.35 – 2.6 MHz | 0.35 – 1.3 MHz | 0.35 – 0.65 MHz |
| 0.7 – 35 MHz  | 0.7 – 19.5 MHz  | 0.7 – 13 MHz  | 0.7 – 5.2 MHz  | 0.7 – 2.6 MHz  | 0.7 – 1.3 MHz  |                 |
| 1.4 – 35 MHz  | 1.4 – 19.5 MHz  | 1.4 – 13 MHz  | 1.4 – 5.2 MHz  | 1.4 – 2.6 MHz  |                |                 |
| 2.8 – 35 MHz  | 2.8 – 19.5 MHz  | 2.8 – 13 MHz  | 2.8 – 5.2 MHz  |                |                |                 |
| 7 – 35 MHz    | 7 – 19.5 MHz    | 7 – 13 MHz    |                |                |                |                 |
| 10.5 – 35 MHz | 10.5 – 19.5 MHz | 10.5 – 13 MHz |                |                |                |                 |

Current mode of signal presentation (**Display**)









|                                 |   |   |   |
|---------------------------------|---|---|---|
| 0.5 <b>Gain</b><br>11 dB        | ← | 1 | → |
| <b>Filter</b><br>BB             | ← | 2 | → |
| <b>Frequency</b><br>0.35-35 MHz | ← | 3 | → |
| <b>Display</b><br>Full          | ← | 4 | → |
| 5 <b>Reject</b><br>0 %          | ← | 5 | → |

To select mode of signal presentation (**Display**) the following manipulations are applicable:









- **Mouse / Touch Screen**

- Click or press and hold on the appropriate button

- **Keyboard**

- Press  on front panel keyboard or **F4** or **<Alt>+<I>** on external keyboard ⇒ **Display** fore color changes to white - then use , , ,  on front panel keyboard or , , ,  on external keyboard

- **Combined**

- Click on **Display** ⇒ **Display** fore color changes to white - then use , , ,  on front panel keyboard or , , ,  on external keyboard





- ◆ There are four **Display modes** for *time domain signal presentation*:

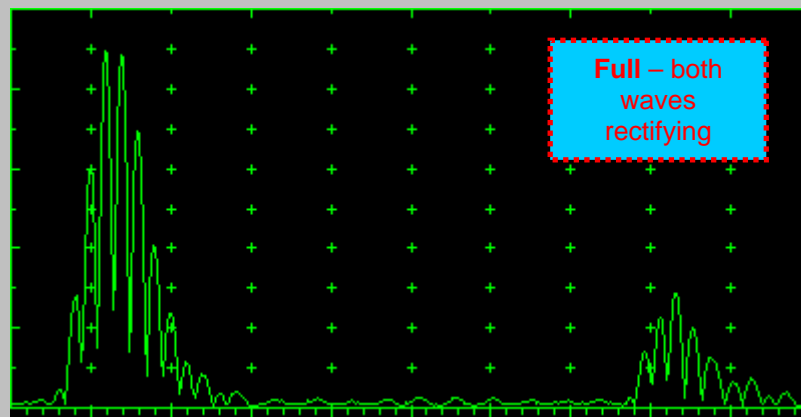
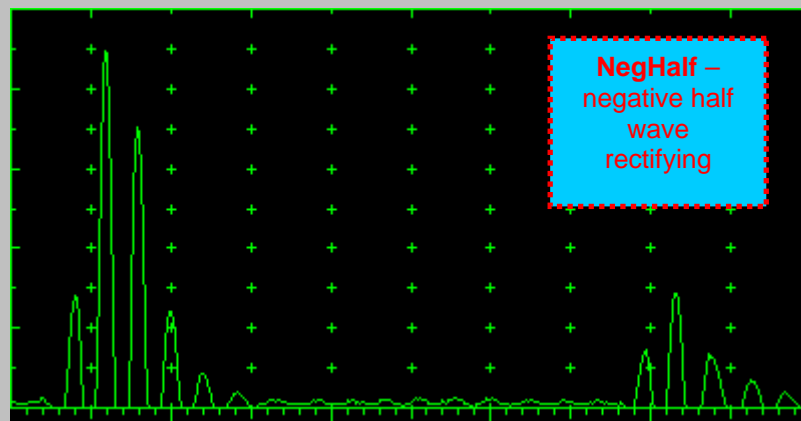
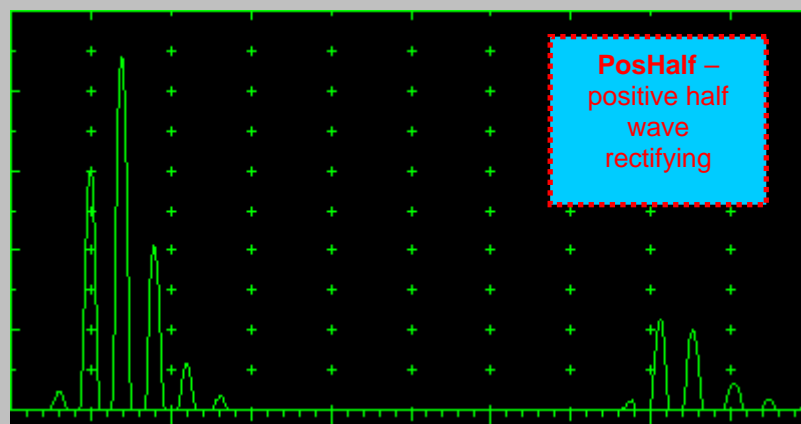
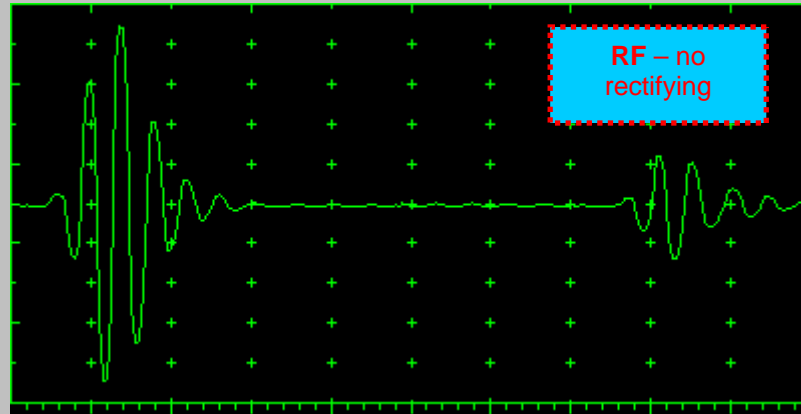

- ◆ Frequency domain signal presentation is available through **FFT Display mode**. Refer to paragraph 5.2.14 of this Operating Manual for instructions related to frequency domain signal presentation

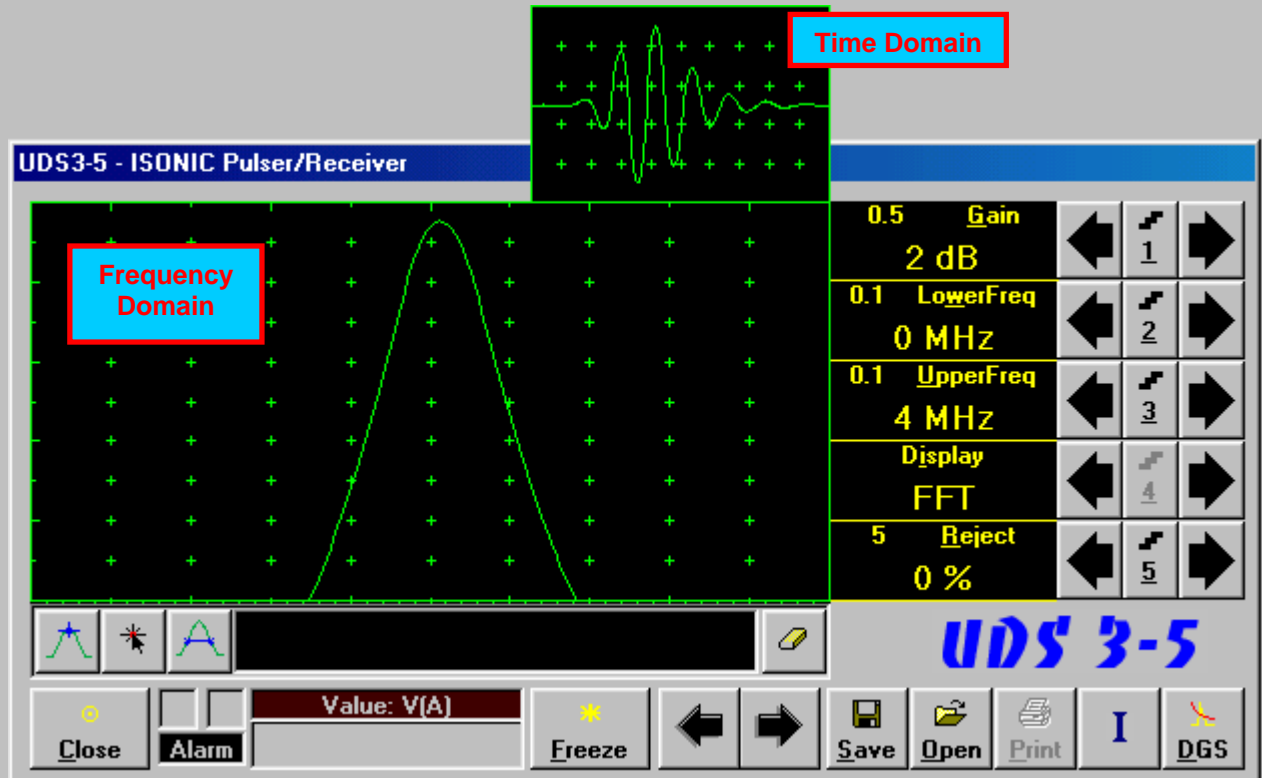

Frequency Domain Signal presentation is not possible if:

- DAC is active (refer to paragraph 5.2.9 of this Operating Manual)
- TCG is active (refer to paragraph 5.2.9 of this Operating Manual)

## 5.2.5. Sub Menu GATE A

Current status of Gate A

|         |            |   |   |   |
|---------|------------|---|---|---|
| 0.5     | Gain       | ← | 1 | → |
| 3       | dB         | ← | 2 | → |
| aSwitch | ON         | ← | 3 | → |
| 2       | aStart     | ← | 4 | → |
| 26      | mm         | ← | 5 | → |
| 2       | aWidth     | ← |   | → |
| 8       | mm         | ← |   | → |
| 10      | aThreshold | ← |   | → |
| 45      | %          | ← |   | → |

To switch **Gate A ON / OFF** the following manipulations are applicable:

- **Mouse / Touch Screen**

- Click or press and hold on the appropriate button

- **Keyboard**







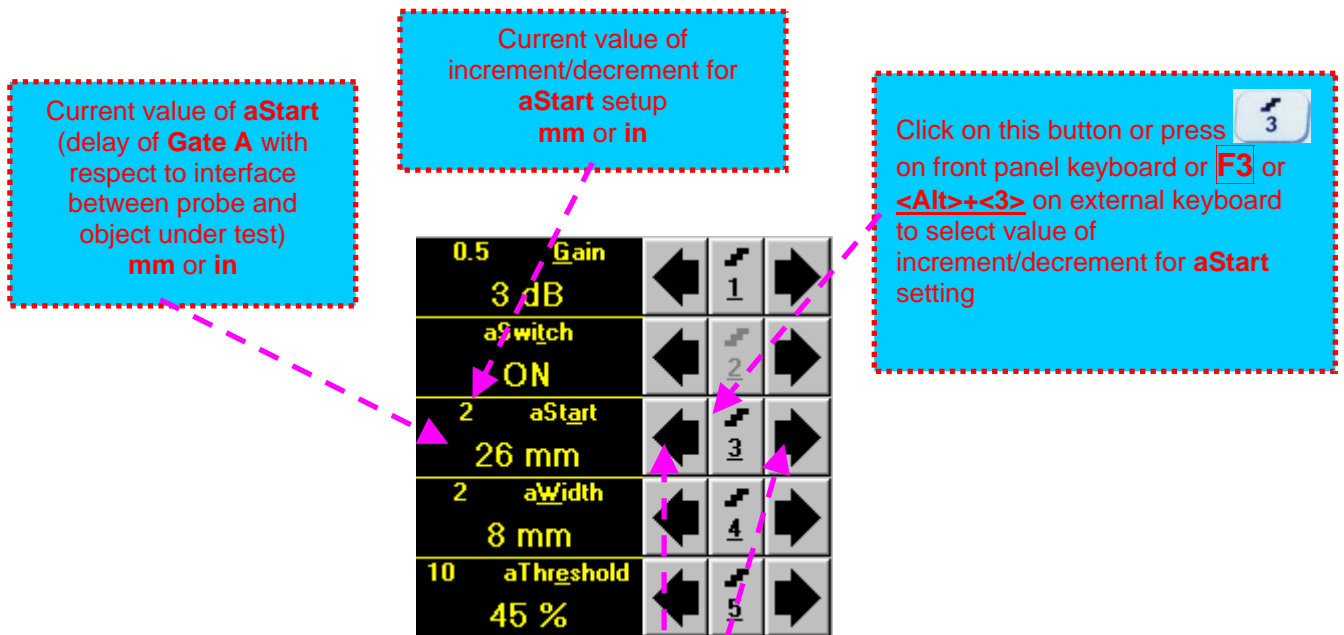









- Press 2 on front panel keyboard or **F2** or **<Alt>+<T>** on external keyboard ⇒ **aSwitch** fore color changes to white - then use ↑, →, ←, ↓ on front panel keyboard or ↑, →, ←, ↓ on external keyboard

- **Combined**

- Click on **aSwitch** ⇒ **aSwitch** fore color changes to white - then use ↑, →, ←, ↓ on front panel keyboard or ↑, →, ←, ↓ on external keyboard



To control delay of **Gate A (aStart)** the following manipulations are applicable:

- **Mouse / Touch Screen**
  - Click or press and hold on the appropriate button
- **Keyboard**
  - Press  on front panel keyboard or **F3** or **<Alt>+<A>** on external keyboard ⇒ **aStart** fore color changes to white - then use , , ,  on front panel keyboard or , , ,  on external keyboard
- **Combined**
  - Click on **aStart** ⇒ **aStart** fore color changes to white - then use , , ,  on front panel keyboard or , , ,  on external keyboard
- **Drag and Drop (refer to paragraph 5.2.7 of this Operating Manual)**



- ◆ **aStart** setup is also possible through a number of other submenus following the same rules as above
- ◆ Counting of **aStart** value starts after finishing of **Probe Delay** count (refer to paragraphs 5.2.12 and 5.2.13 of this Operating Manual)

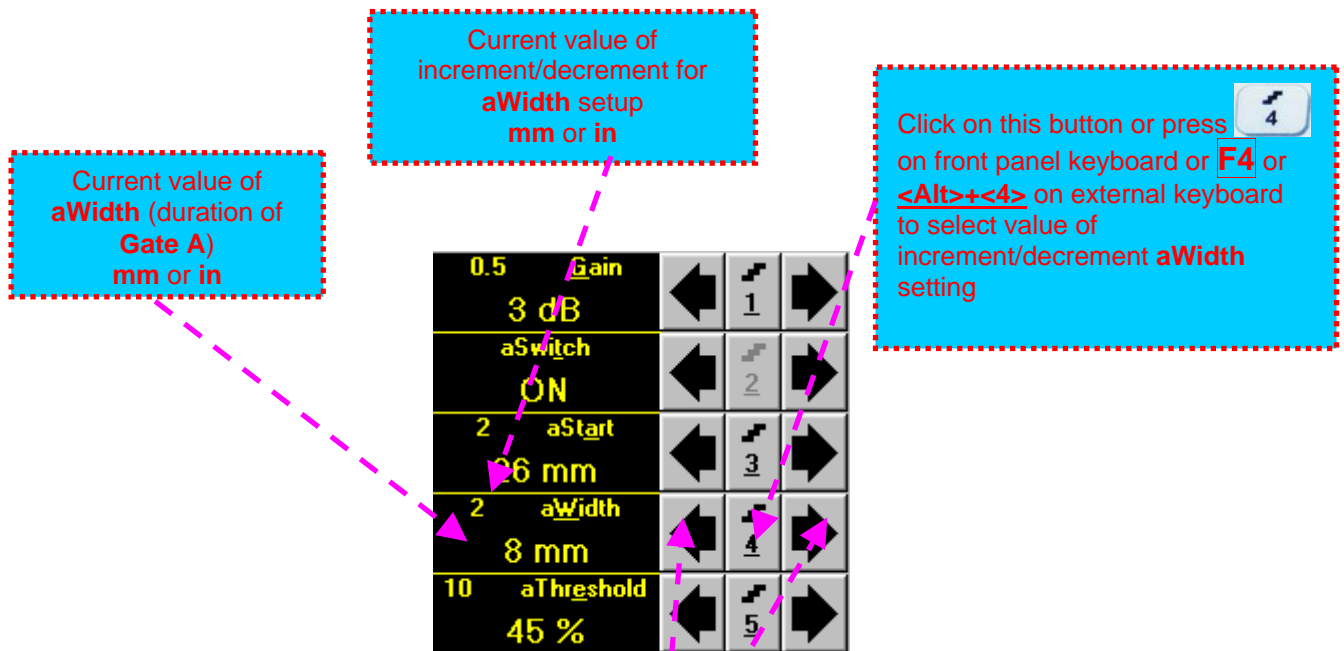









To control duration of **Gate A** (**aWidth**) the following manipulations are applicable:









- **Mouse / Touch Screen**

- Click or press and hold on the appropriate button

- **Keyboard**

- Press  on front panel keyboard or **F4** or **<Alt>+<W>** on external keyboard ⇒ **aWidth** fore color changes to white - then use , , ,  on front panel keyboard or , , ,  on external keyboard

- **Combined**

- Click on **aWidth** ⇒ **aWidth** fore color changes to white - then use , , ,  on front panel keyboard or , , ,  on external keyboard

- **Drag and Drop (refer to paragraph 5.2.7 of this Operating Manual)**

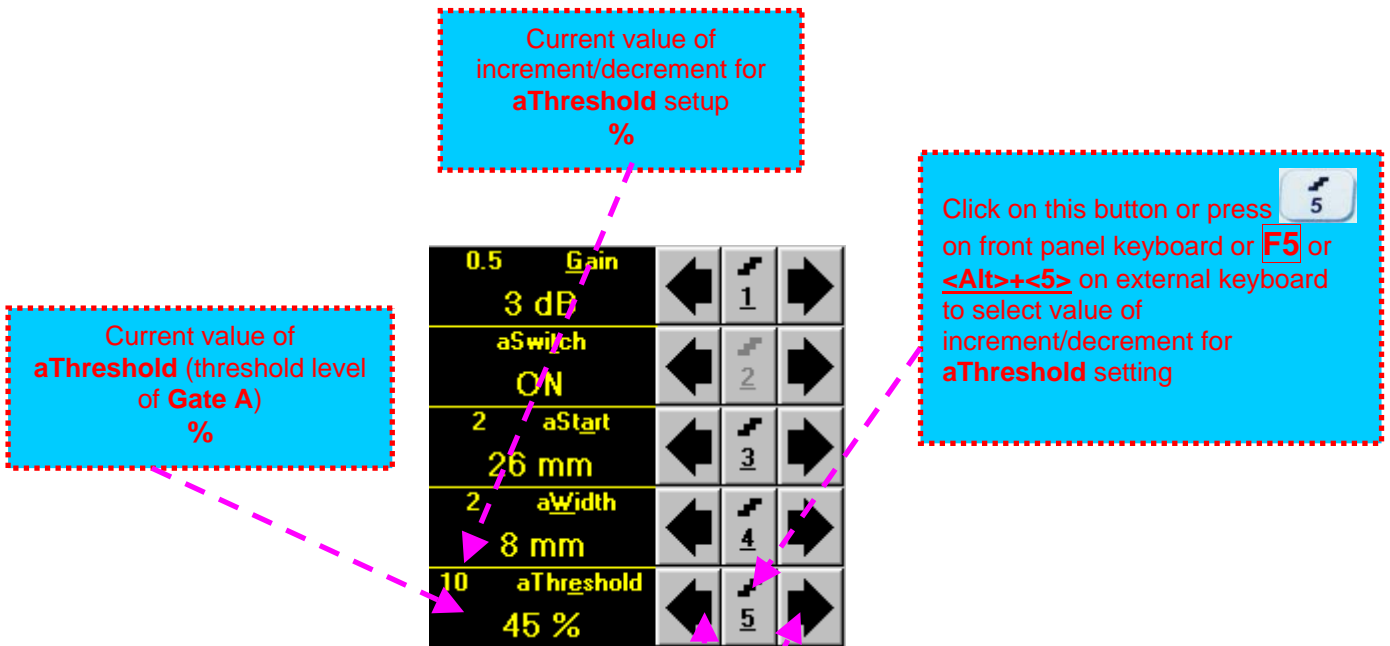

To control threshold level of **Gate A** (**aThreshold**) the following manipulations are applicable:

- **Mouse / Touch Screen**

- Click or press and hold on the appropriate **button**

- **Keyboard**

- Press on front panel keyboard or **F5** or **<Alt>+<E>** on external keyboard ⇒ **aThreshold** fore color changes to white - then use , , , on front panel keyboard or , , , on external keyboard

- **Combined**

- Click on **aThreshold** ⇒ **aThreshold** fore color changes to white - then use , , , on front panel keyboard or , , , on external keyboard

- **Drag and Drop (refer to paragraph 5.2.7 of this Operating Manual)**

## 5.2.6. Sub Menu GATE B

Current status of Gate B

|         |            |   |   |   |
|---------|------------|---|---|---|
| 0.5     | Gain       | ← | 1 | → |
| 3       | dB         | ← | 2 | → |
| bSwitch | ON         | ← | 3 | → |
| 2       | bStart     | ← | 4 | → |
| 47.9    | mm         | ← | 5 | → |
| 2       | bWidth     | ← |   | → |
| 13.2    | mm         | ← |   | → |
| 10      | bThreshold | ← |   | → |
| 40      | %          | ← |   | → |

To switch **Gate B ON / OFF** the following manipulations are applicable:

- **Mouse / Touch Screen**

- Click or press and hold on the appropriate button

- **Keyboard**

- Press 2 on front panel keyboard or **F2** or **<Alt>+<T>** on external keyboard ⇒ **bSwitch** fore color changes to white - then use ↑, →, ←, ↓ on front panel keyboard or ↑, →, ←, ↓ on external keyboard

- **Combined**

- Click on **bSwitch** ⇒ **bSwitch** fore color changes to white - then use ↑, →, ←, ↓ on front panel keyboard or ↑, →, ←, ↓ on external keyboard

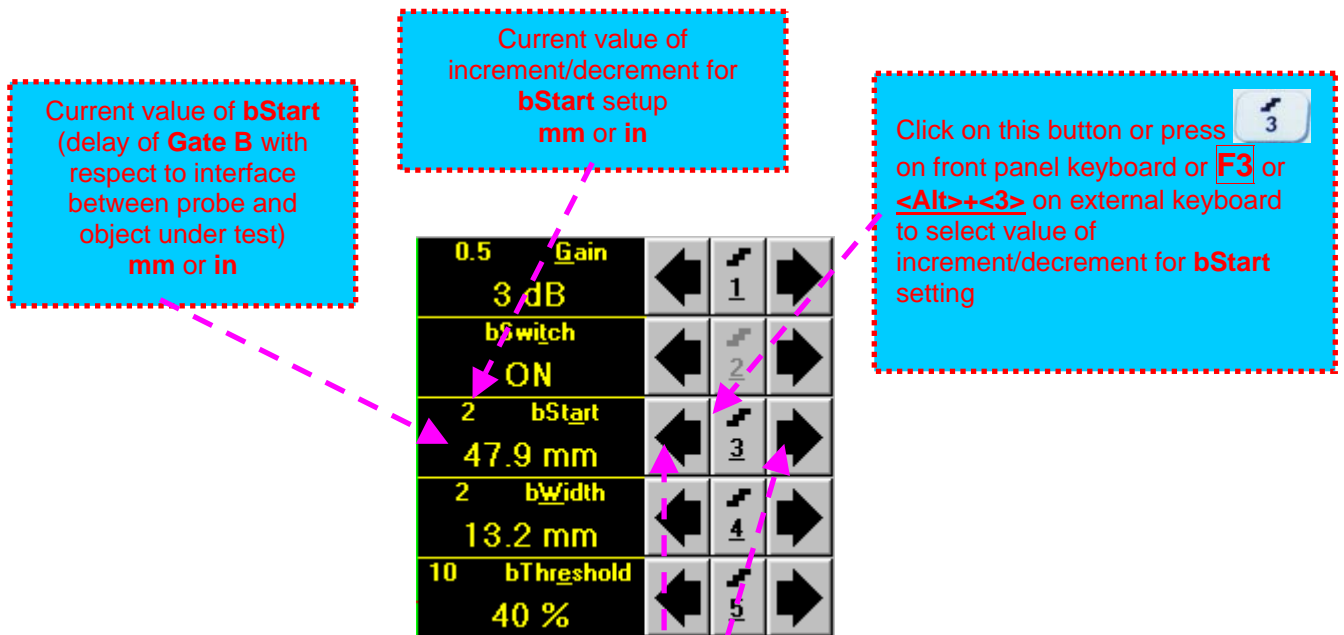

To control delay of **Gate B (bStart)** the following manipulations are applicable:

- **Mouse / Touch Screen**
  - Click or press and hold on the appropriate button
- **Keyboard**
  - Press on front panel keyboard or **F3** or **<Alt>+<A>** on external keyboard ⇒ **bStart** fore color changes to white - then use , , , on front panel keyboard or , , , on external keyboard
- **Combined**
  - Click on **bStart** ⇒ **bStart** fore color changes to white - then use , , , on front panel keyboard or , , , on external keyboard
- **Drag and Drop (refer to paragraph 5.2.7 of this Operating Manual)**



Counting of **bStart** value starts after finishing of **Probe Delay** count (refer to paragraph 5.2.12 and 5.2.13 of this Operating Manual)



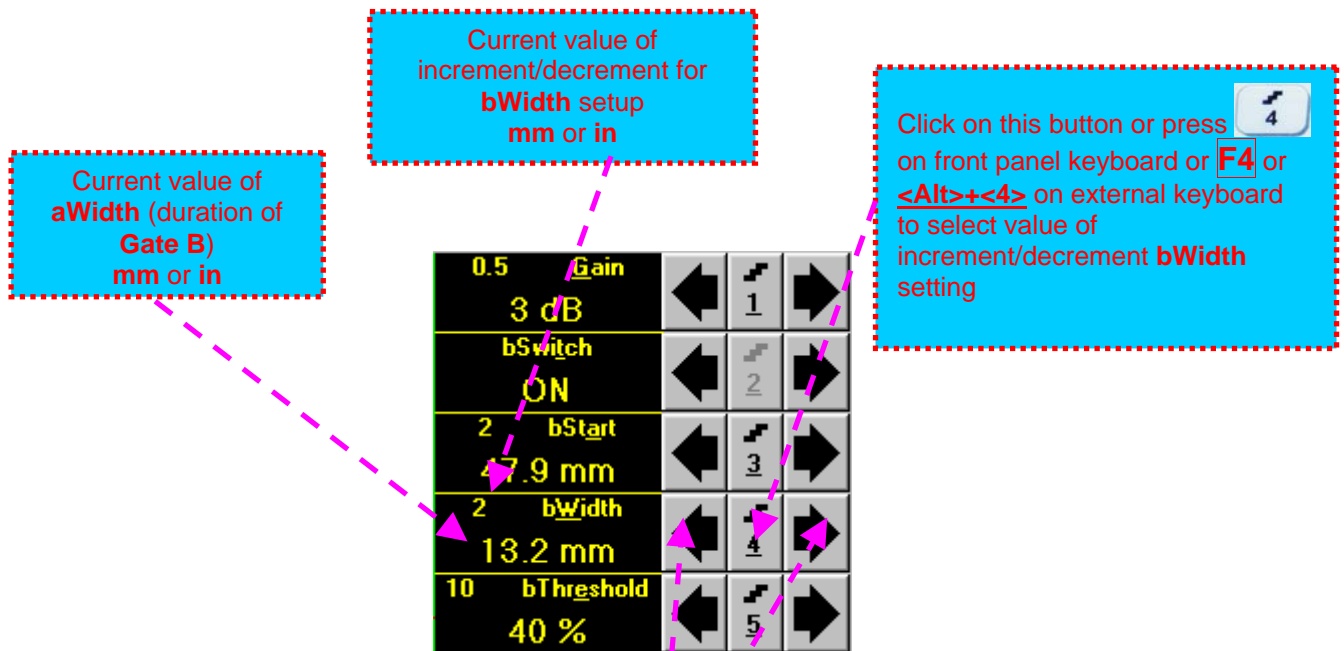









To control duration of **Gate B** (**bWidth**) the following manipulations are applicable:









- **Mouse / Touch Screen**

- Click or press and hold on the appropriate button

- **Keyboard**

- Press  on front panel keyboard or **F4** or **<Alt>+<W>** on external keyboard ⇒ **bWidth** fore color changes to white - then use , , ,  on front panel keyboard or , , ,  on external keyboard

- **Combined**

- Click on **bWidth** ⇒ **bWidth** fore color changes to white - then use , , ,  on front panel keyboard or , , ,  on external keyboard

- **Drag and Drop (refer to paragraph 5.2.7 of this Operating Manual)**

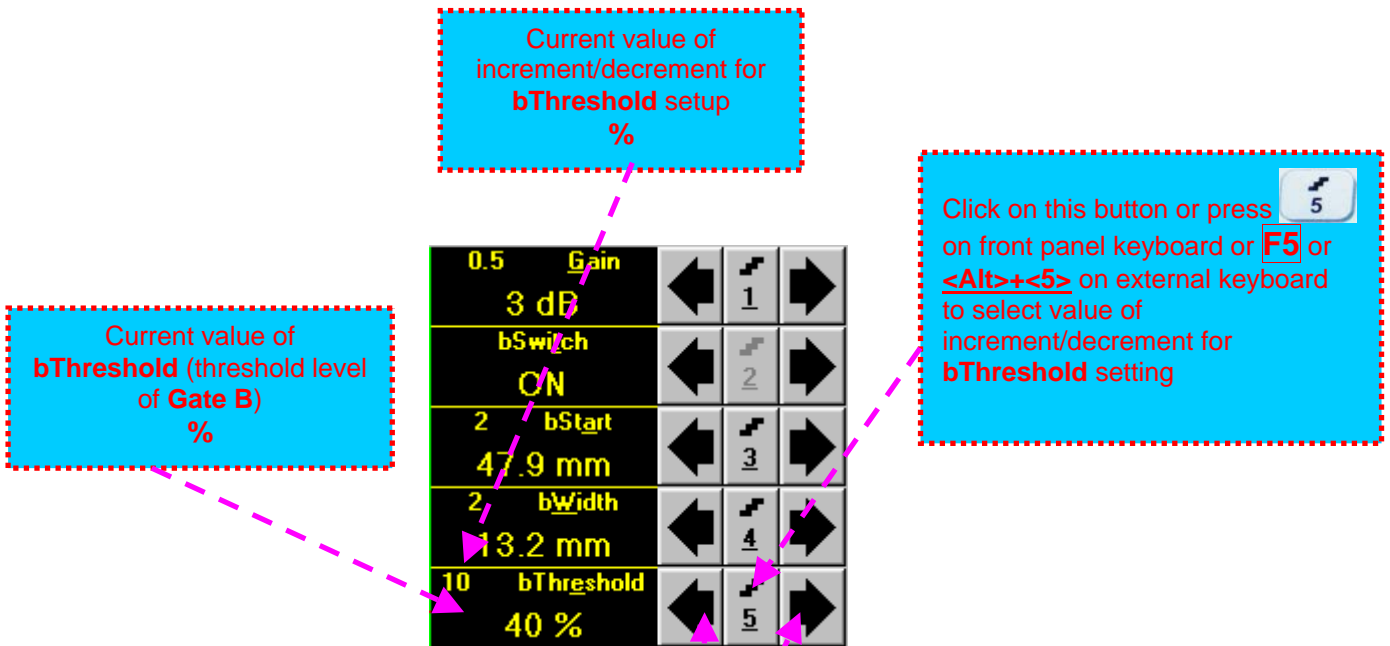

To control threshold level of **Gate B** (**bThreshold**) the following manipulations are applicable:

- **Mouse / Touch Screen**

- Click or press and hold on the appropriate button

- **Keyboard**

- Press 5 on front panel keyboard or **F5** or **<Alt>+<E>** on external keyboard ⇒ **bThreshold** fore color changes to white - then use , , , on front panel keyboard or , , , on external keyboard

- **Combined**

- Click on **bThreshold** ⇒ **bThreshold** fore color changes to white - then use , , , on front panel keyboard or , , , on external keyboard

- **Drag and Drop (refer to paragraph 5.2.7 of this Operating Manual)**

## 5.2.7. Drag and Drop: Gate A and Gate B

Gate A and Gate B may be manipulated through Drag and Drop provided that they are visible in the A-Scan area. Mouse pointer changes shape while placing it above appropriate section of a gate

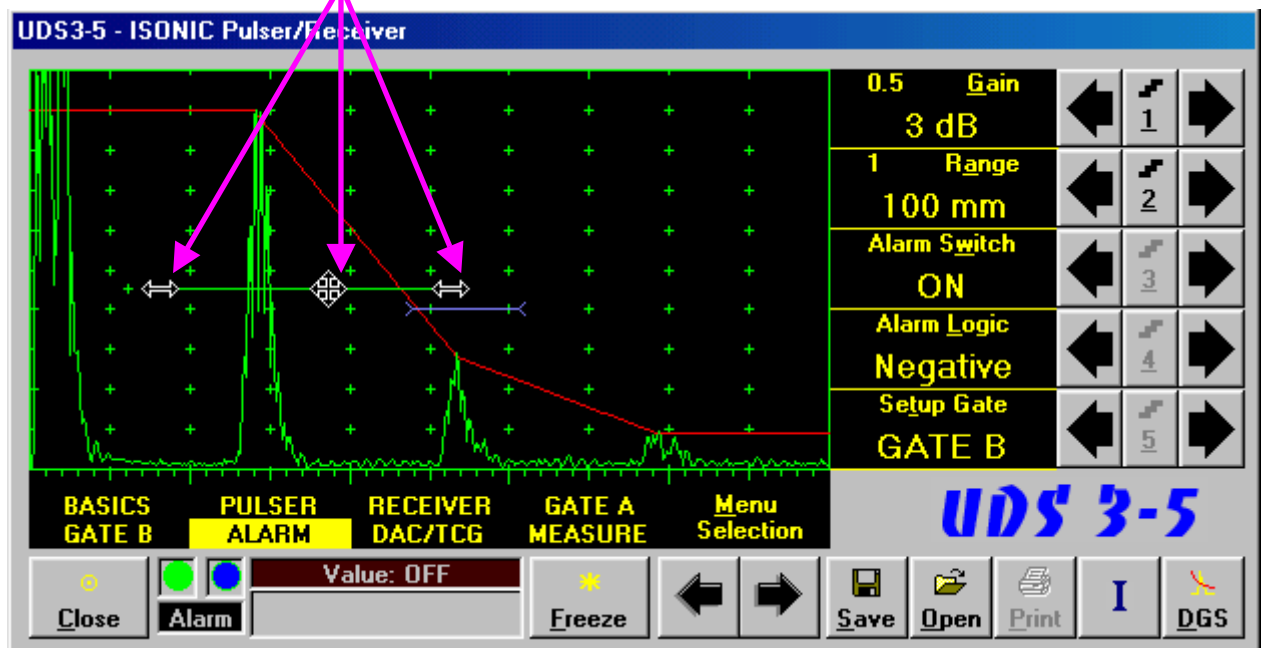

To manage a gate just press and hold left mouse button or touch screen stylus and drag, then drop through releasing of left mouse button or touch screen stylus

## 5.2.8. Sub Menu ALARM

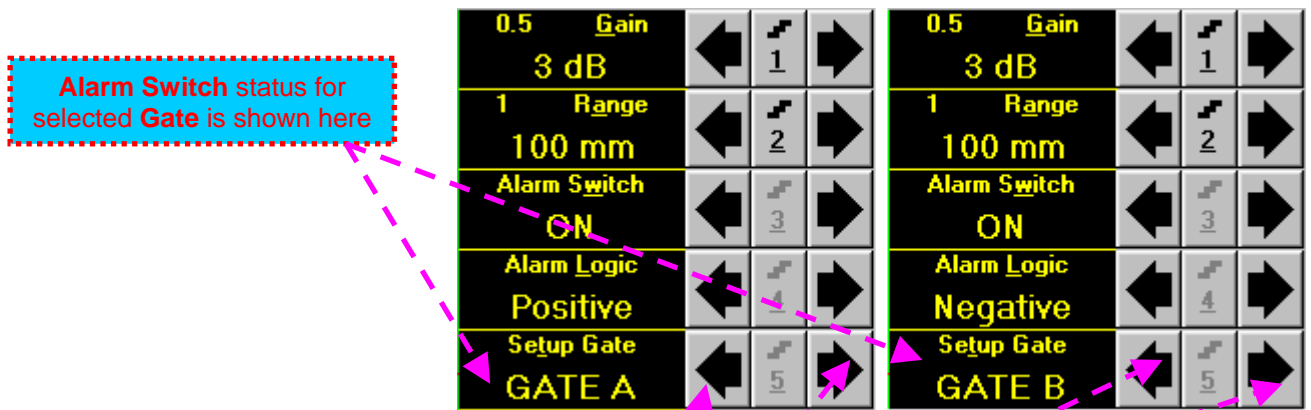









To select a **Gate** for **Alarm Setup** the following manipulations are applicable:









- **Mouse / Touch Screen**

- Click or press and hold on the appropriate **button**

- **Keyboard**

- Press  on front panel keyboard or **F5** or **<Alt>+<T>** on external keyboard ⇒ **Setup Gate** fore color changes to white - then use , , ,  on front panel keyboard or , , ,  on external keyboard

- **Combined**

- Click on **Setup Gate** ⇒ **Setup Gate** fore color changes to white - then use , , ,  on front panel keyboard or , , ,  on external keyboard

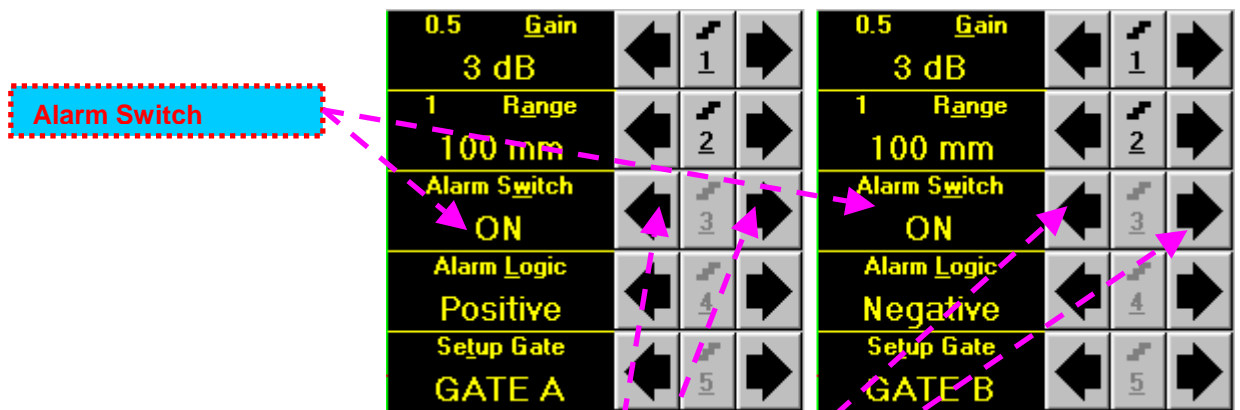

To control **Alarm Switch** the following manipulations are applicable:

- **Mouse / Touch Screen**

- Click or press and hold on the appropriate button

- **Keyboard**

- Press 3 on front panel keyboard or **F3** or **<Alt>+<W>** on external keyboard ⇒ **Alarm Switch** fore color changes to white - then use ↑, →, ←, ↓ on front panel keyboard or ↑, →, ←, ↓ on external keyboard

- **Combined**

- Click on **Alarm Switch** ⇒ **Alarm Switch** fore color changes to white - then use ↑, →, ←, ↓ on front panel keyboard or ↑, →, ←, ↓ on external keyboard

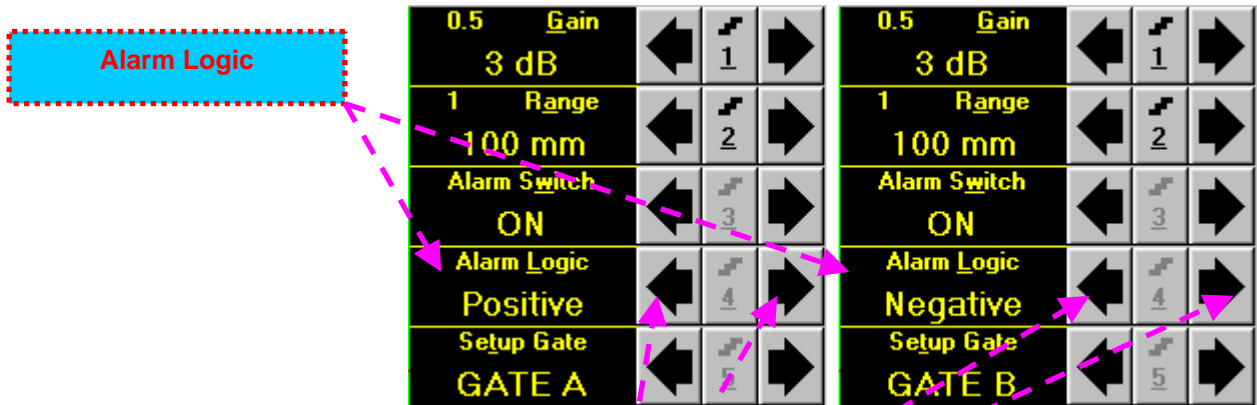









To select **Alarm Logic** the following manipulations are applicable:









- **Mouse / Touch Screen**

- Click or press and hold on the appropriate button

- **Keyboard**

- Press  on front panel keyboard or **F4** or **<Alt>+<L>** on external keyboard ⇒ **Alarm Logic** fore color changes to white - then use , , ,  on front panel keyboard or , , ,  on external keyboard

- **Combined**

- Click on **Alarm Logic** ⇒ **Alarm Logic** fore color changes to white - then use , , ,  on front panel keyboard or , , ,  on external keyboard



## Alarm Example

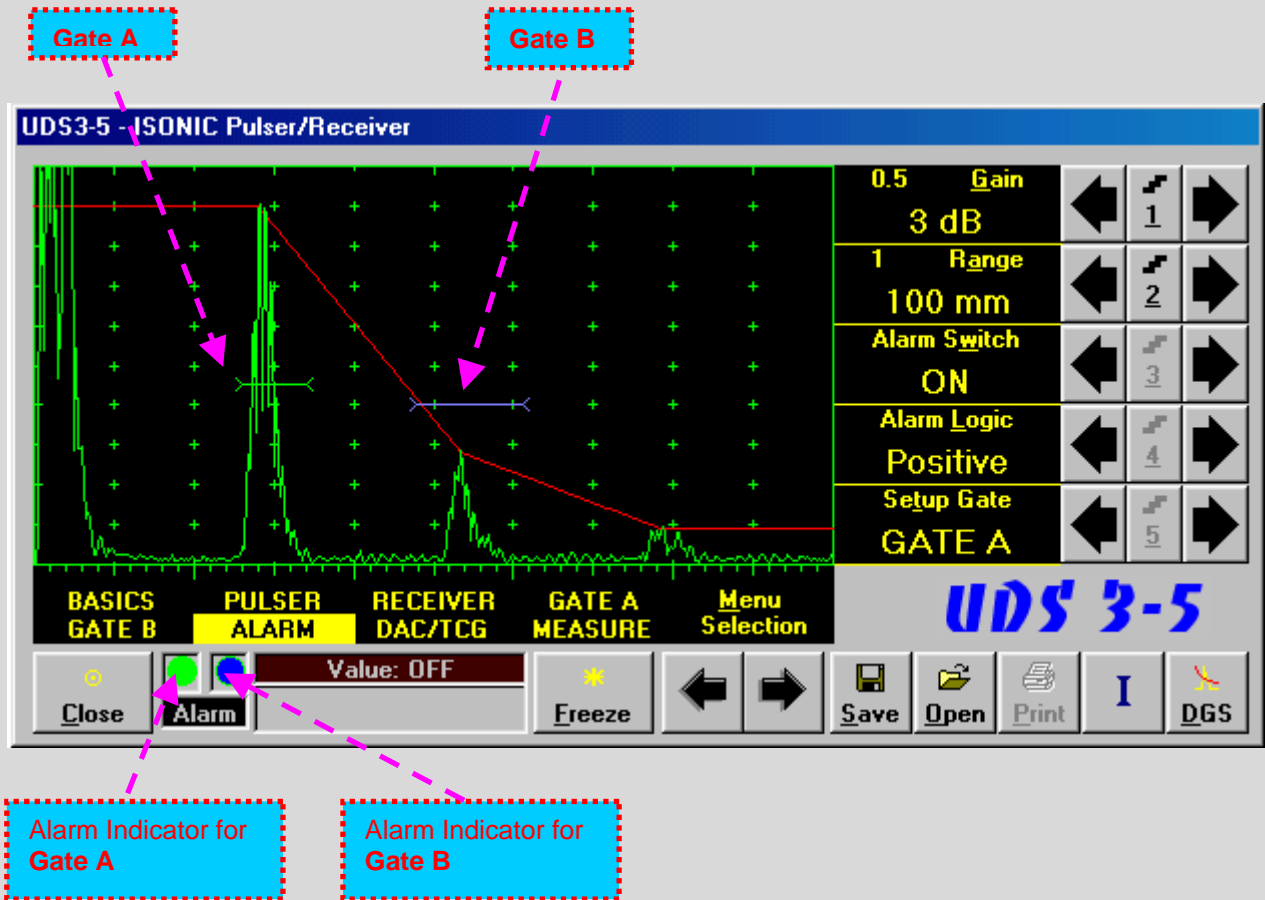

- ◆ There is a pulse matching with **Gate A** and exceeding its threshold; the **Alarm Logic** setting for **Gate A** is **Positive** ⇒ **Alarm Indicator for Gate A** is active
- ◆ There is a pulse matching with **Gate B** and not exceeding its threshold; the **Alarm Logic** setting for **Gate B** is **Negative** ⇒ **Alarm Indicator for the Gate B** is active

## 5.2.9. Sub Menu DAC/TCG

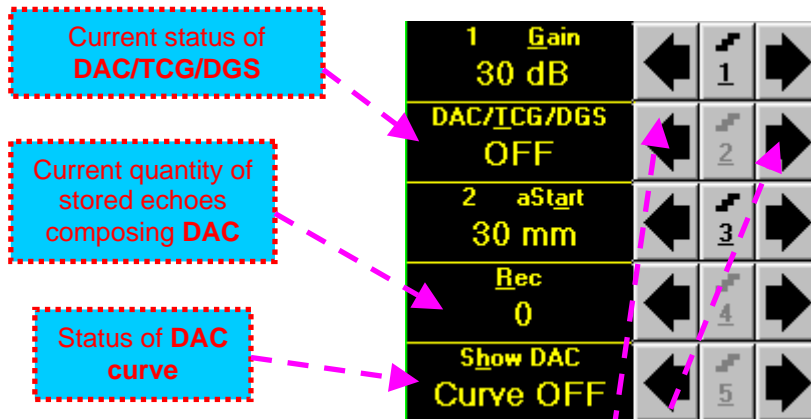

To select required mode for **DAC/TCG/DGS** the following manipulations are applicable:

- **Mouse / Touch Screen**
  - Click or press and hold on the appropriate button
- **Keyboard**
  - Press 2 on front panel keyboard or **F2** or **<Alt>+<T>** on external keyboard ⇒ **DAC/TCG/DGS** fore color changes to white - then use ↑, →, ←, ↓ on front panel keyboard or ↑, →, ←, ↓ on external keyboard
- **Combined**
  - Click on **DAC/TCG/DGS** ⇒ **DAC/TCG/DGS** fore color changes to white - then use ↑, →, ←, ↓ on front panel keyboard or ↑, →, ←, ↓ on external keyboard



- ◆ There are four possible modes for **DAC/TCG**:
  - There are four possible modes for **DAC/TCG**:
    - **OFF** - **DAC Curve** switches automatically to **OFF** while in **OFF**
    - **DAC** - available if quantity of stored echoes is 2 (two) or more. **DAC Curve** switches automatically to **ON** while in **DAC** mode. Both experimental and theoretical methods for creating **DAC** are available
    - **TCG** - available if quantity of stored echoes is 2 (two) or more. **DAC Curve** switches automatically to **OFF** while in **TCG** mode
    - **Update** - allows to create/update new/existing **DAC**. **Update** of existing **DAC** performed through erasing of a number of sequentially recorded echoes, starting from the latest one, and/or recording of new echoes. The maximal number of echoes recorded into the one **DAC** is 40 (forty). **DAC Curve** switches automatically to **ON** if the number of recorded echoes is 2 (two) or more and switches automatically to **OFF** if number of recorded echoes is less than 2 (two) while in **Update** mode
- ◆ It is possible to Create / Modify / Activate **DAC** and **TCG** for all **Display** modes (**RF**, **Full**, **Negative**, and **Positive**)
- ◆ To create / modify **DAC/TCG** or **DGS** refer to paragraphs 5.2.10, 5.2.11 of this Operating Manual



## 5.2.10. Create / Modify DAC

### 5.2.10.1 Theoretical DAC: dB/mm (dB/in)

Theoretical **DAC** represents pure exponential law for distance amplitude curve; said law is determined by **dB/mm (dB/in)** factor and value of **Probe Delay** - refer to paragraphs 5.2.12, 5.2.13 of this Operating Manual: at zero material travel distance theoretical **DAC** has start point at 100% of A-Scan height

Set **DAC/TCG/DGS** to **Update** then click **on**

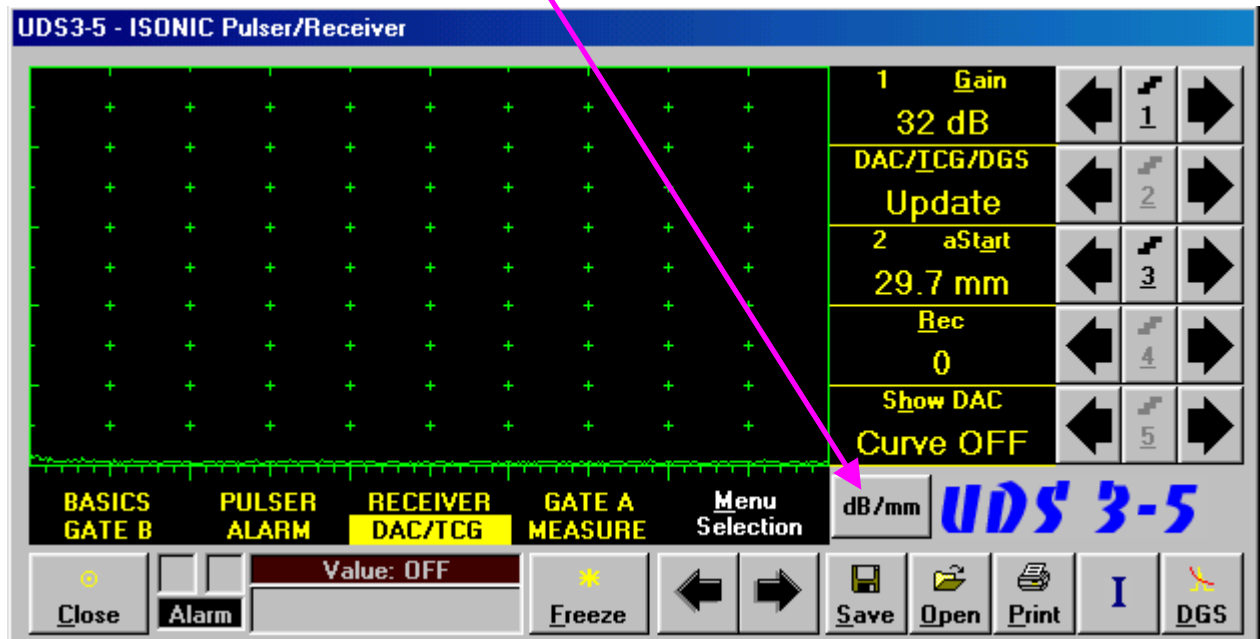

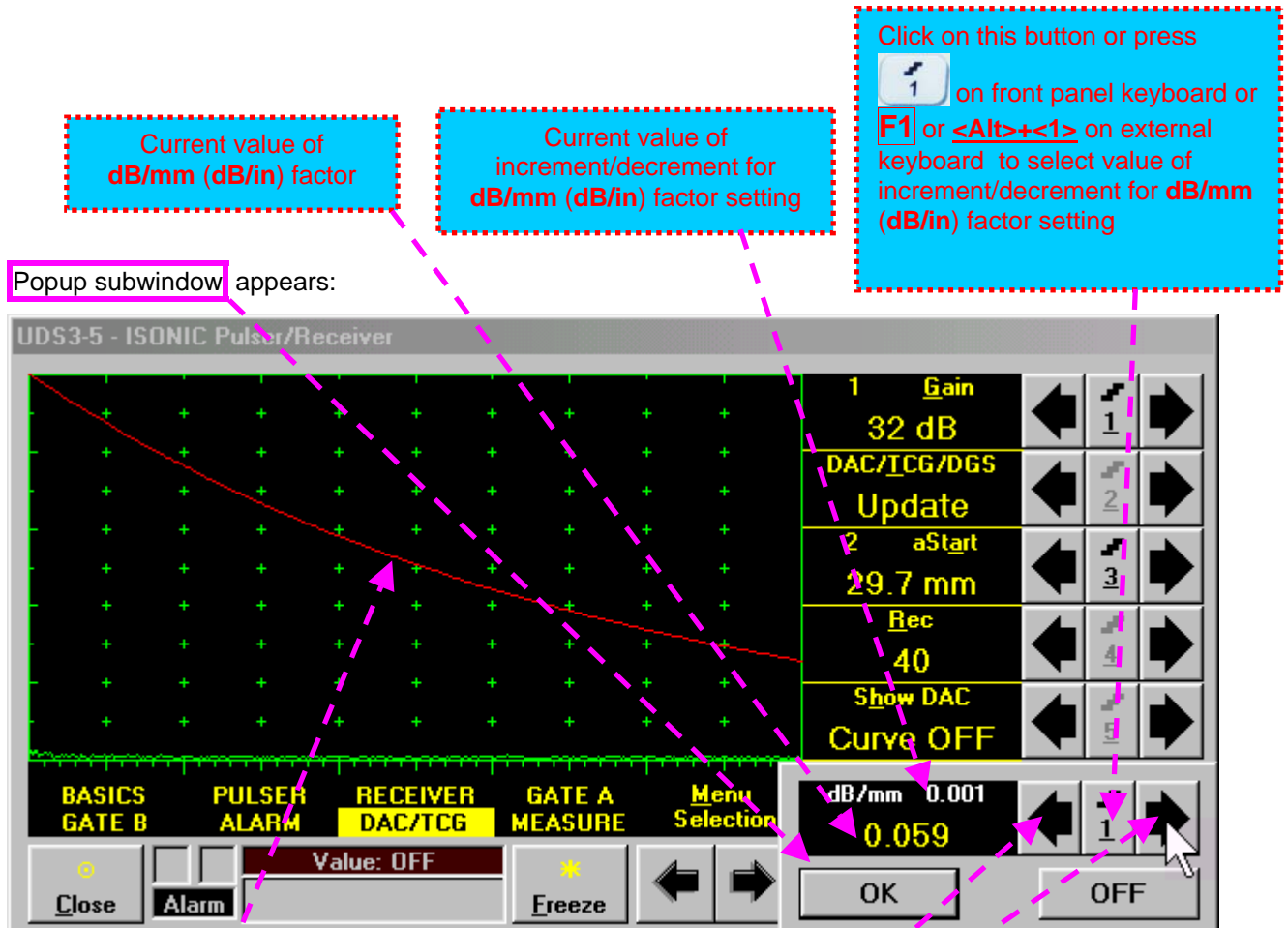

Theoretical DAC according to entered dB/mm (dB/in) factor

To control dB/mm (dB/in) factor the following manipulations are applicable:

- **Mouse / Touch Screen**

- Click or press and hold on the appropriate **button**

- **Keyboard**

- Press , , , on front panel keyboard or , , , on external keyboard

On completing dB/mm (dB/in) factor setting click on **OK** or press on front panel keyboard **Enter** on external keyboard. This will return to main operating surface of UDS 3-5 Pulsar Receiver and

activate theoretical DAC. Button **dB/mm** becomes green while theoretical DAC is setup; set **DAC/TCG/DGS** to **DAC** to activate theoretical DAC or to **TCG** if it is necessary to perform time correction of gain in accordance with theoretical DAC law.

To modify or switch theoretical DAC off set **DAC/TCG/DGS** to **Update** then click on **dB/mm**. In the appeared popup subwindow modify value dB/mm (dB/in) factor as it is described above or click on **OFF** then on **OK**

### 5.2.10.2 Experimental DAC: recording signals from variously located reflectors

If theoretical **DAC** is active then it must be switched off according to paragraph 5.2.10.1 of this Operating Manual prior to building of experimental **DAC**. Switch on **Gate A** then set **DAC/TCG/DGS** to **Update**. Place probe onto **DAC** calibration block and maximize echo from the reflector closest to the probe (first echo) then place **Gate A** over received signal and capture first *DAC echo*

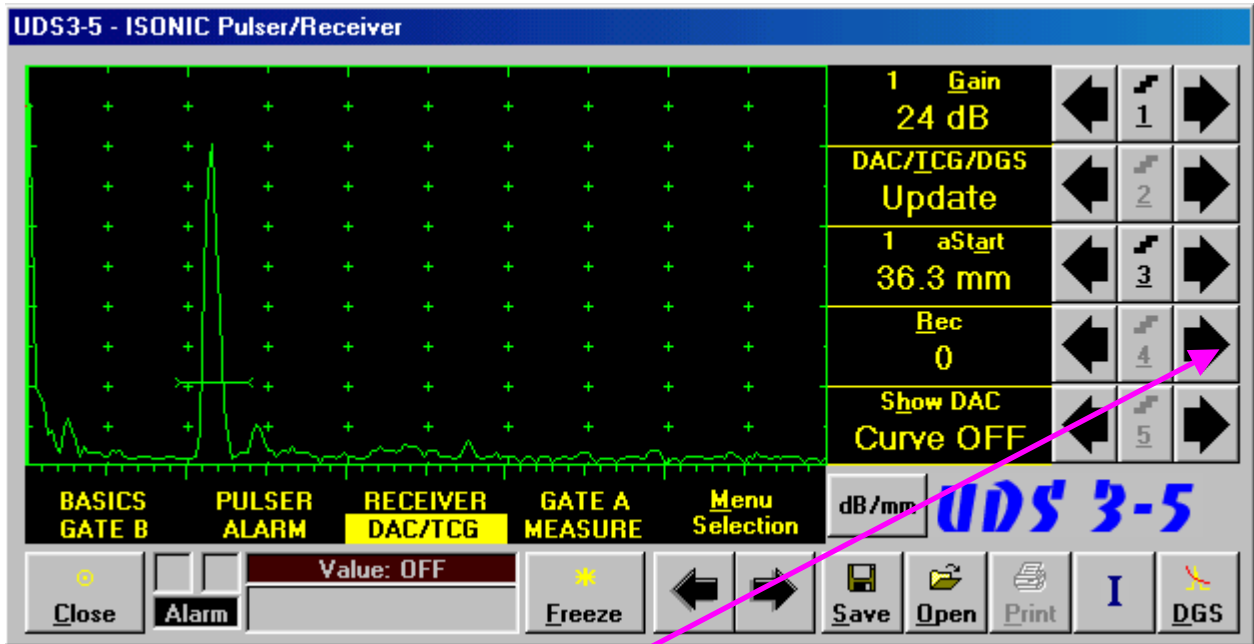

To capture *DAC echo* the following manipulations are applicable:

- **Mouse / Touch Screen**

- Click **on**

- **Keyboard**

- Press **4** on front panel keyboard or **F4** or **<Alt>+<R>** on external keyboard ⇒ **Rec** fore color changes to white - then use **↑**, **→**, **←**, **↓** on front panel keyboard or **↑**, **→**, **←**, **↓** on external keyboard

- **Combined**

- Click on **Rec** ⇒ **Rec** fore color changes to white - then use **↑**, **→** on front panel keyboard or **↑**, **→** on external keyboard

As a result the *first DAC echo* will be stored and corresponding **indication** will appear



Place probe onto DAC calibration block and maximize echo from next reflector then place **Gate A** over received signal and capture *next DAC echo*. As result next *DAC echo* will be stored causing appropriate modifying of corresponding indications

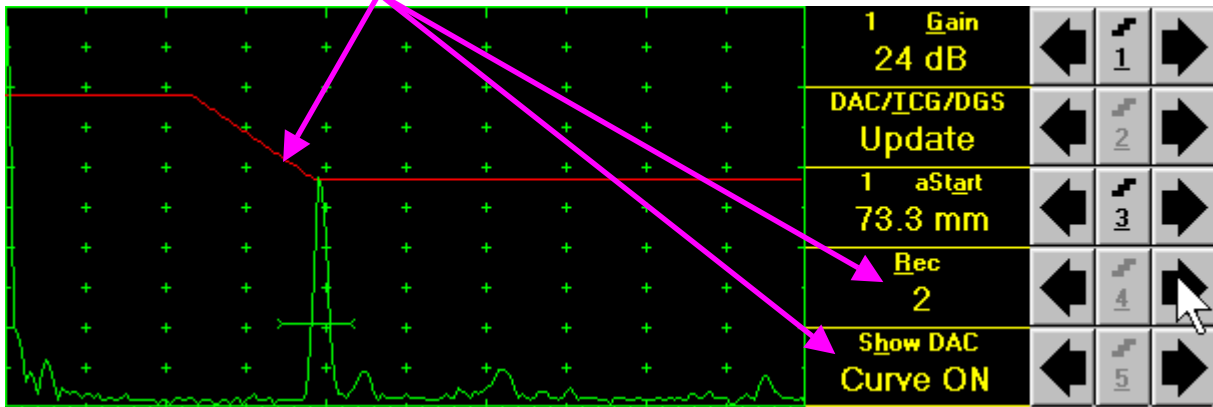

- ◆ The highest echo in the **Gate A** will be stored said echo may either exceed **Gate A** threshold level or not
- ◆ Stored echo must be below 100% of **A-Scan** height
- ◆ A total number of 40 echoes may be stored one by one by the same way as described above

After creating a DAC (2 or more echoes stored) the DAC and / or TCG may be activated. There are two styles of DAC indication in the DAC mode: **Main Curve Only** and **Main Curve  $\pm$  N dB**, where **N may be setup either as 2, 4, 6, 8, 10, 12, or 14 dB**. To proceed follow the rules below:

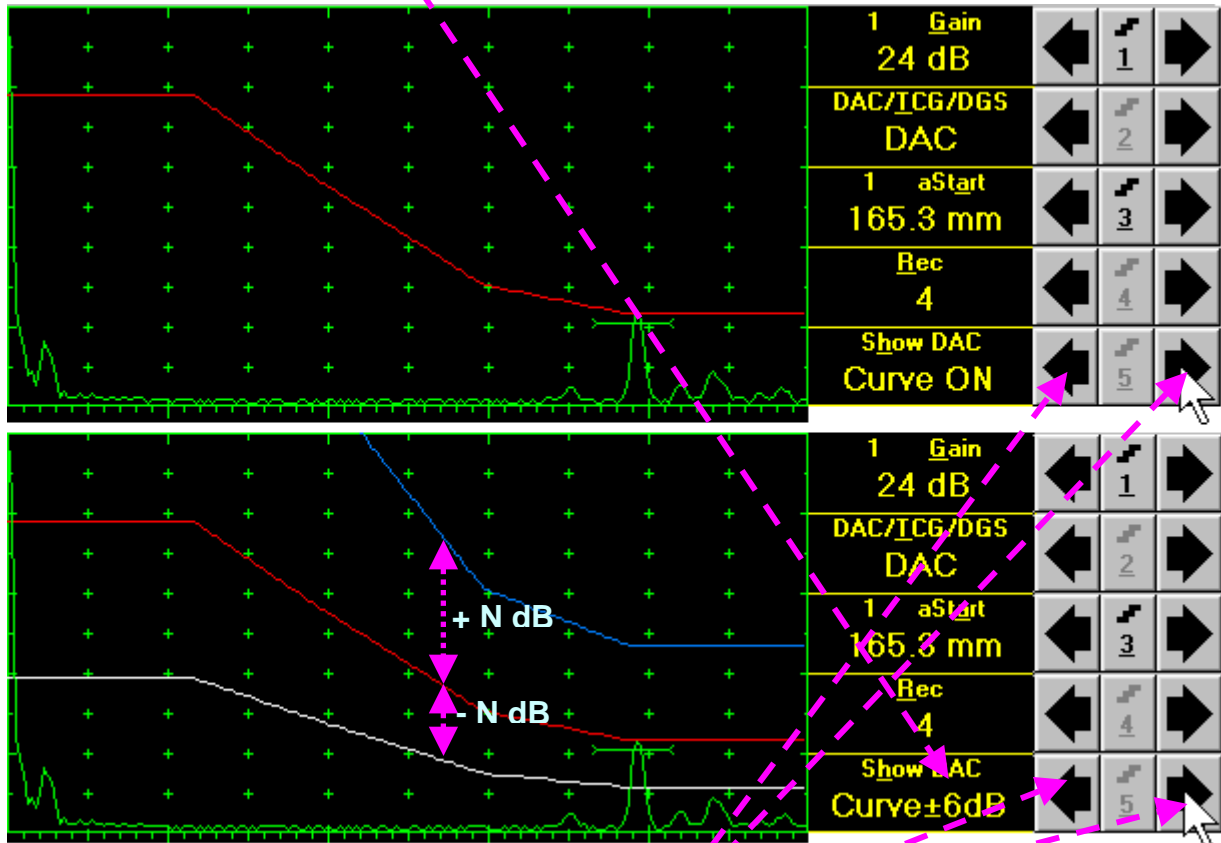

- **Mouse / Touch Screen**
  - Click or press and hold on the appropriate button
- **Keyboard**
  - Press 5 on front panel keyboard or **F5** or **<Alt>+<H>** on external keyboard  $\Rightarrow$  **Show DAC** fore color changes to white - then use ↑, →, ←, ↓ on front panel keyboard or ↑, →, ←, ↓ on external keyboard
- **Combined**
  - Click on **Show DAC**  $\Rightarrow$  **Show DAC** fore color changes to white - then use ↑, →, ←, ↓ on front panel keyboard or ↑, →, ←, ↓ on external keyboard

It's possible to erase the last stored echo from the **DAC**. To proceed set the **DAC/TCG/DGS** to **Update**:

To erase the last stored echo from the **DAC** the following manipulations are applicable:

- **Mouse / Touch Screen**

- Click on on

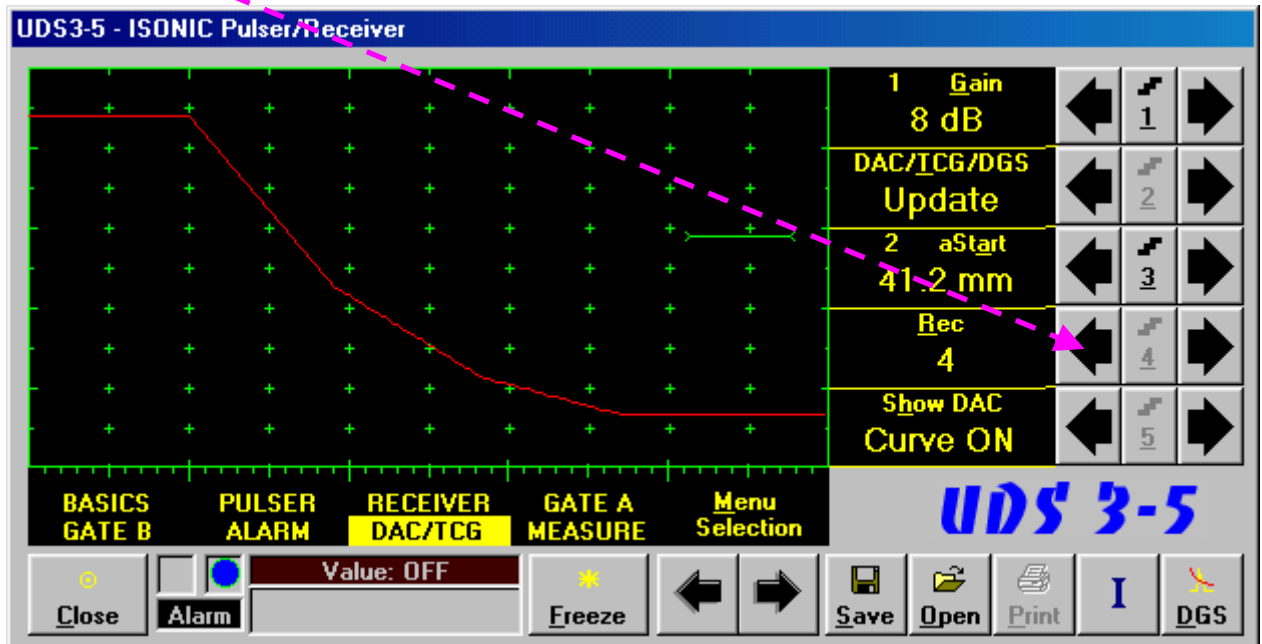

- **Keyboard**

- Press 4 on front panel keyboard or **F4** or **<Alt>+<R>** on external keyboard ⇒ **Rec** fore color changes to white - then use ←, ↓ on front panel keyboard or ←, ↓ on external keyboard



- **Combined**

- Click on **Rec** ⇒ **Rec** fore color changes to white - then use ←, ↓ on front panel keyboard or ←, ↓ on external keyboard

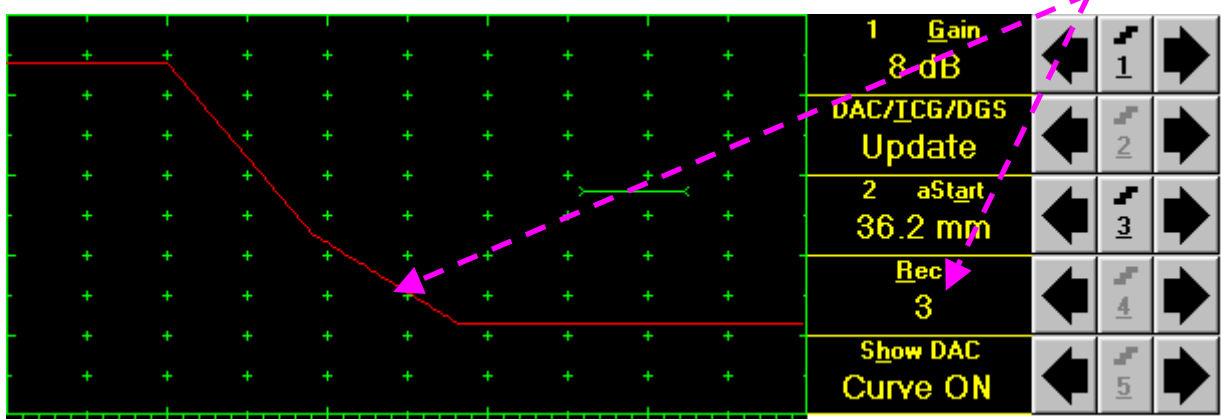
As a result the last stored echo will be erased causing appropriate modifying of corresponding indications



## 5.2.11. DGS

To setup **DGS** set **Display** to **Full** then click on  or press  on front panel keyboard or **F9** or **<Alt>+<D>** on external keyboard. The following screen appears:

Back echo amplitude as function of metal travel distance in the *reference block* for the selected probe

Disk shaped reflector (flat bottom hole - **FBH**) echo amplitude as function of metal travel distance in the *material under test* for the selected probe and **FBH** diameter

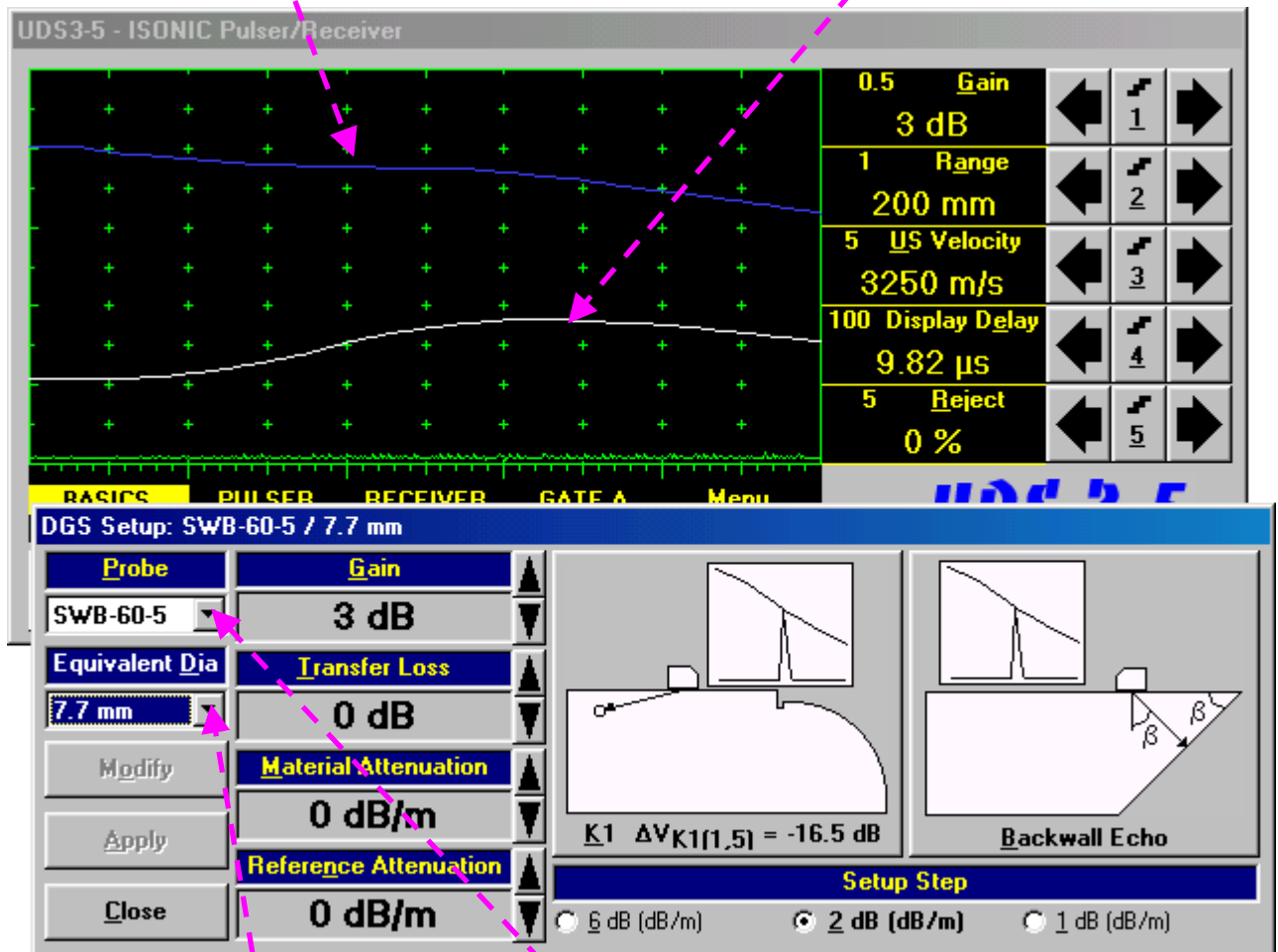

UDS3-5 - ISONIC Pulsar/Receiver

0.5 Gain 3 dB

1 Range 200 mm

5 US Velocity 3250 m/s

100 Display Delay 9.82  $\mu$ s

5 Reject 0 %

RASICS PULSER RECEIVER GATE A Menu

DGS Setup: SWB-60-5 / 7.7 mm

|                |                       |
|----------------|-----------------------|
| Probe          | Gain                  |
| SWB-60-5       | 3 dB                  |
| Equivalent Dia | Transfer Loss         |
| 7.7 mm         | 0 dB                  |
| Modify         | Material Attenuation  |
| Apply          | 0 dB/m                |
| Close          | Reference Attenuation |
|                | 0 dB/m                |

$K_1 \Delta V_{K_1(1,5)} = -16.5$  dB

Backwall Echo

Setup Step

6 dB (dB/m)  2 dB (dB/m)  1 dB (dB/m)

Equivalent Diameter (FBH) selection box

Probe selection box

To activate **DGS** follow the steps below:

### **Step 1: Probe Selection**

The following manipulations are applicable for the **Probe** selection:





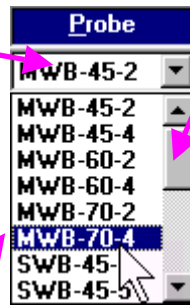



- **Mouse / Touch Screen**

- Click on **on**
- Scroll probes list to see the selected one











- Click on **selected probe**

- **Keyboard**

- Press **<Alt>+<P>** on external keyboard ⇒ **Probe** fore color changes to white – then use , , ,  on front panel keyboard or , , ,  on external keyboard

- **Combined**

- Click on **Probe** ⇒ **Probe** fore color changes to white - then use , , ,  on front panel keyboard or , , ,  on external keyboard



## Step 2: Equivalent Diameter of disk shaped reflector (flat bottom hole – FBH)

The following manipulations are applicable for the selection of the **Equivalent Diameter** of disk shaped reflector:





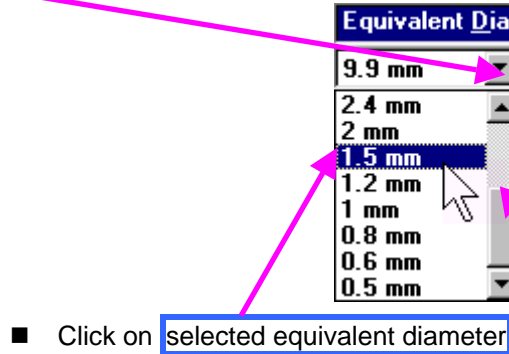



- **Mouse / Touch Screen**

- Click on **on**
- Scroll diameters list to see the selected one











- Click on **selected equivalent diameter**

- **Keyboard**

- Press **<Alt>+<D>** on external keyboard ⇒ **Equivalent Dia** fore color changes to white – then use  ,  ,  ,  on front panel keyboard or  ,  ,  ,  on external keyboard

- **Combined**

- Click on **Equivalent Dia** ⇒ **Equivalent Dia** fore color changes to white – then use  ,  ,  ,  on front panel keyboard or  ,  ,  ,  on external keyboard







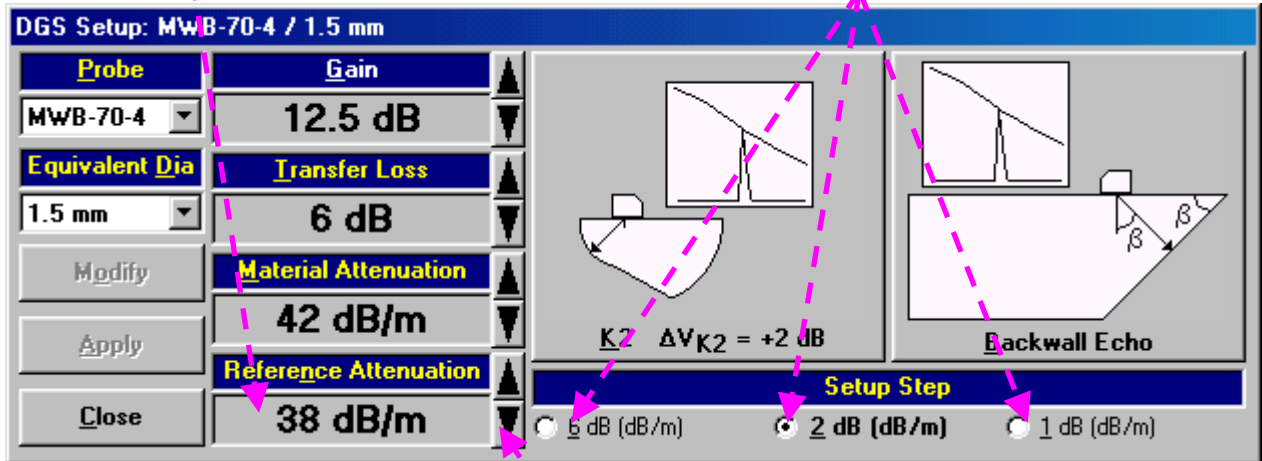









**Step 3: Attenuation in the reference block**

Current setting of **Reference Attenuation** (attenuation in the reference block) **dB/m**

Click on **Setup Step** option or press **<Alt>+<1>** or **<Alt>+<2>** or **<Alt>+<6>** on external keyboard to select required value for increment / decrement for setting **Reference Attenuation**. The last selected value of increment / decrement is checked: 



The following manipulations are applicable:

- **Mouse / Touch Screen**
  - Click or press and hold on the appropriate button
- **Keyboard**
  - Press **<Alt>+<N>** on external keyboard ⇒ **Reference Attenuation** fore color changes to white - then use , , ,  on front panel keyboard or , , ,  on external keyboard
- **Combined**
  - Click on **Reference Attenuation** ⇒ **Reference Attenuation** fore color changes to white - then use , , ,  on front panel keyboard or , , ,  on external keyboard







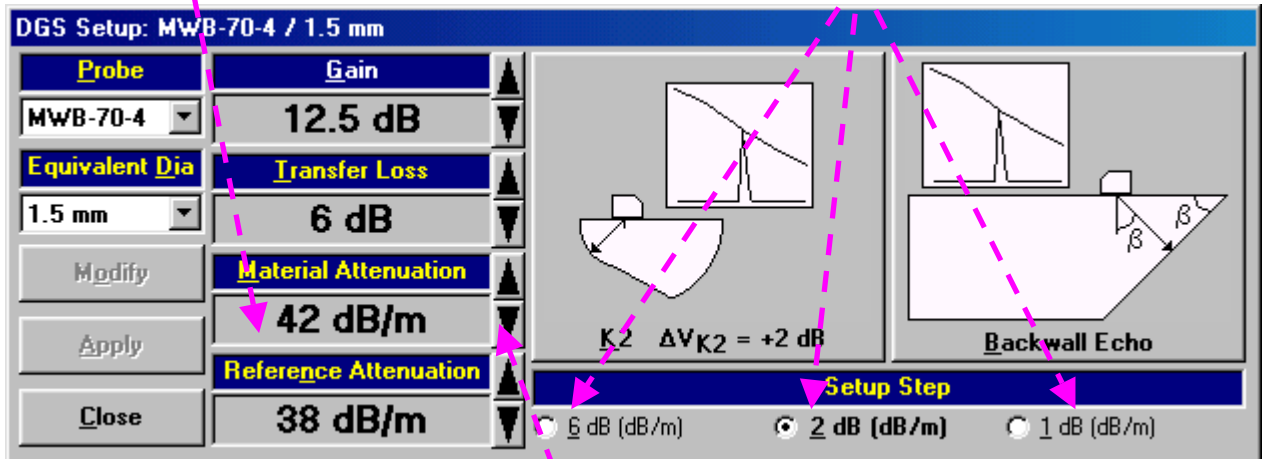









#### Step 4: Attenuation in the object under test

Current setting of **Material Attenuation** (attenuation in the object under test) **dB/m**

Click on **Setup Step** option or press **<Alt>+<1>** or **<Alt>+<2>** or **<Alt>+<6>** on external keyboard to select required value for increment / decrement for setting **Material Attenuation**. The last selected value of increment / decrement is checked:



The following manipulations are applicable:

- **Mouse / Touch Screen**
  - Click or press and hold on the appropriate button
- **Keyboard**
  - Press **<Alt>+<M>** on external keyboard ⇒ **Material Attenuation** fore color changes to white - then use , , ,  on front panel keyboard or , , ,  on external keyboard
- **Combined**
  - Click on **Material Attenuation** ⇒ **Material Attenuation** fore color changes to white - then use , , ,  on front panel keyboard or , , ,  on external keyboard







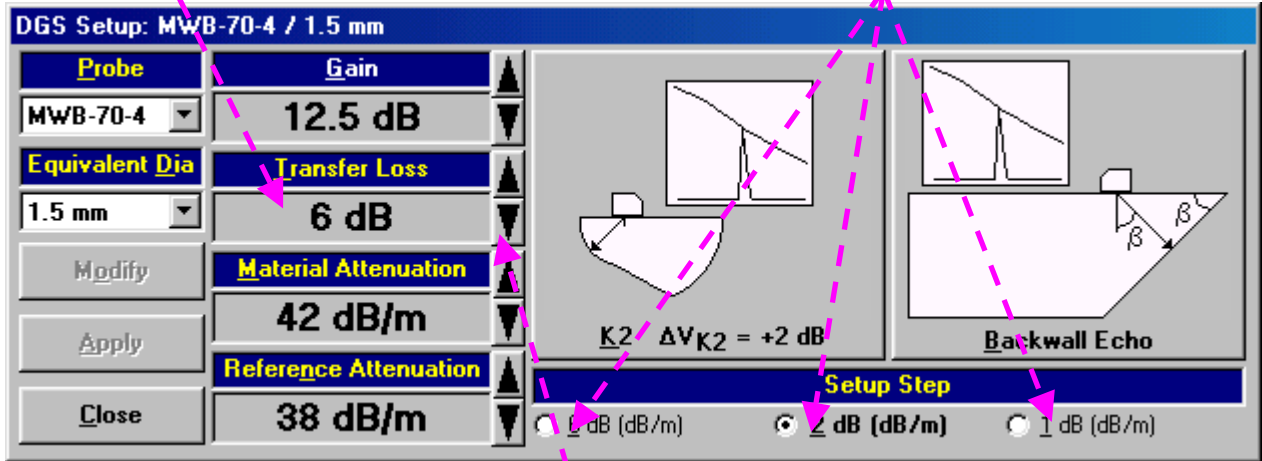









**Step 5: Transfer loss**

Current setting of **Transfer Loss** **dB**

Click on **Setup Step** option or press **<Alt>+<1>** or **<Alt>+<2>** or **<Alt>+<6>** on external keyboard to select required value for increment / decrement for setting **Transfer Loss**. The last selected value of increment / decrement is checked:



The following manipulations are applicable:

- **Mouse / Touch Screen**
  - Click or press and hold on the appropriate button
- **Keyboard**
  - Press **<Alt>+<T>** on external keyboard ⇒ **T**ransfer **L**oss fore color changes to white - then use , , ,  on front panel keyboard or , , ,  on external keyboard
- **Combined**
  - Click on **T**ransfer **L**oss ⇒ **T**ransfer **L**oss fore color changes to white - then use , , ,  on front panel keyboard or , , ,  on external keyboard

**Step 6: Gain**

Apply probe to the reference block to get the appropriate echo. There are two methods available:

- K1 or K2 reference block (reference block and reflector are defined in the probe data sheet and reproduced automatically from the **DGS** data base upon probe selection)
- Inclined reference block (reference reflector – back surface)

The screenshot shows the UDS3-5 - ISONIC Pulsar/Receiver interface. At the top, a graph displays a blue curve representing the back echo level and a green curve representing the reference echo. A dashed pink arrow points from the 'Current Gain dB' callout to the '12.5 dB' value in the Gain field. Below the graph is a control panel with fields for Gain (12.5 dB), Range (100 mm), US Velocity (3250 m/s), Display Delay (6.23 μs), and Reject (0%). Below this is the 'DGS Setup: MWB-70-4 / 1.5 mm' window, which includes a table of parameters and two diagrams: 'K2 ΔVK2 = +2 dB' and 'Backwall Echo'. The 'Setup Step' section at the bottom of the DGS window has three radio buttons: '6 dB (dB/m)', '2 dB (dB/m)' (which is selected), and '1 dB (dB/m)'. A dashed pink arrow points from the '2 dB (dB/m)' radio button to the 'Click on Setup Step...' callout.

| Probe          | Gain                  |
|----------------|-----------------------|
| MWB-70-4       | 12.5 dB               |
| Equivalent Dia | Transfer Loss         |
| 1.5 mm         | 6 dB                  |
| Modify         | Material Attenuation  |
| Apply          | 42 dB/m               |
| Close          | Reference Attenuation |
|                | 38 dB/m               |

Current Gain  
dB

Click on **Setup Step** option or press <Alt>+<1> or <Alt>+<2> or <Alt>+<6> on external keyboard to select required value for increment / decrement for increment / decrement for setting **Gain**. The last selected value of increment / decrement is checked:

The goal of Gain setup is obtaining tip of maximized reference echo reaching back echo level (blue curve)

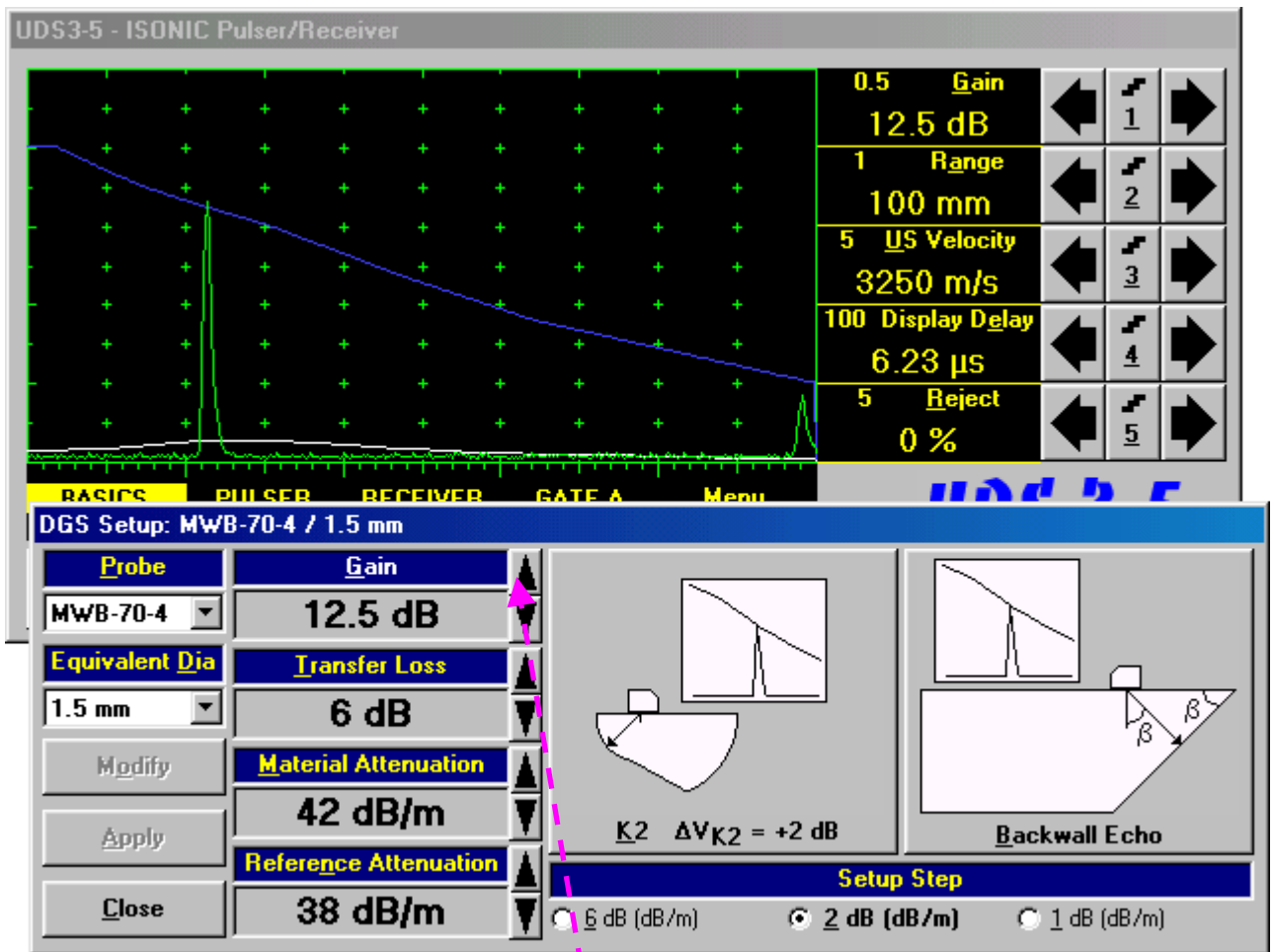









The following manipulations are applicable for **Gain** setup:









- **Mouse / Touch Screen**

- Click or press and hold on the appropriate button

- **Keyboard**

- Press **<Alt>+<G>** on external keyboard ⇒ **G**ain fore color changes to white - then use , , ,  on front panel keyboard or , , ,  on external keyboard

- **Combined**

- Click on **G**ain ⇒ **G**ain fore color changes to white - then use , , ,  on front panel keyboard or , , ,  on external keyboard

**Step 7: Finalizing DGS curve and return to the main UDS 3-3 / UDS 3-4 window**

Before finalizing the **DGS** curve:

Finalized back echo curve (blue) – depends on **Probe and Reference Attenuation**

Finalized FBH echo curve (white) – depends on **Probe, Equivalent Dia, and Material Attenuation**

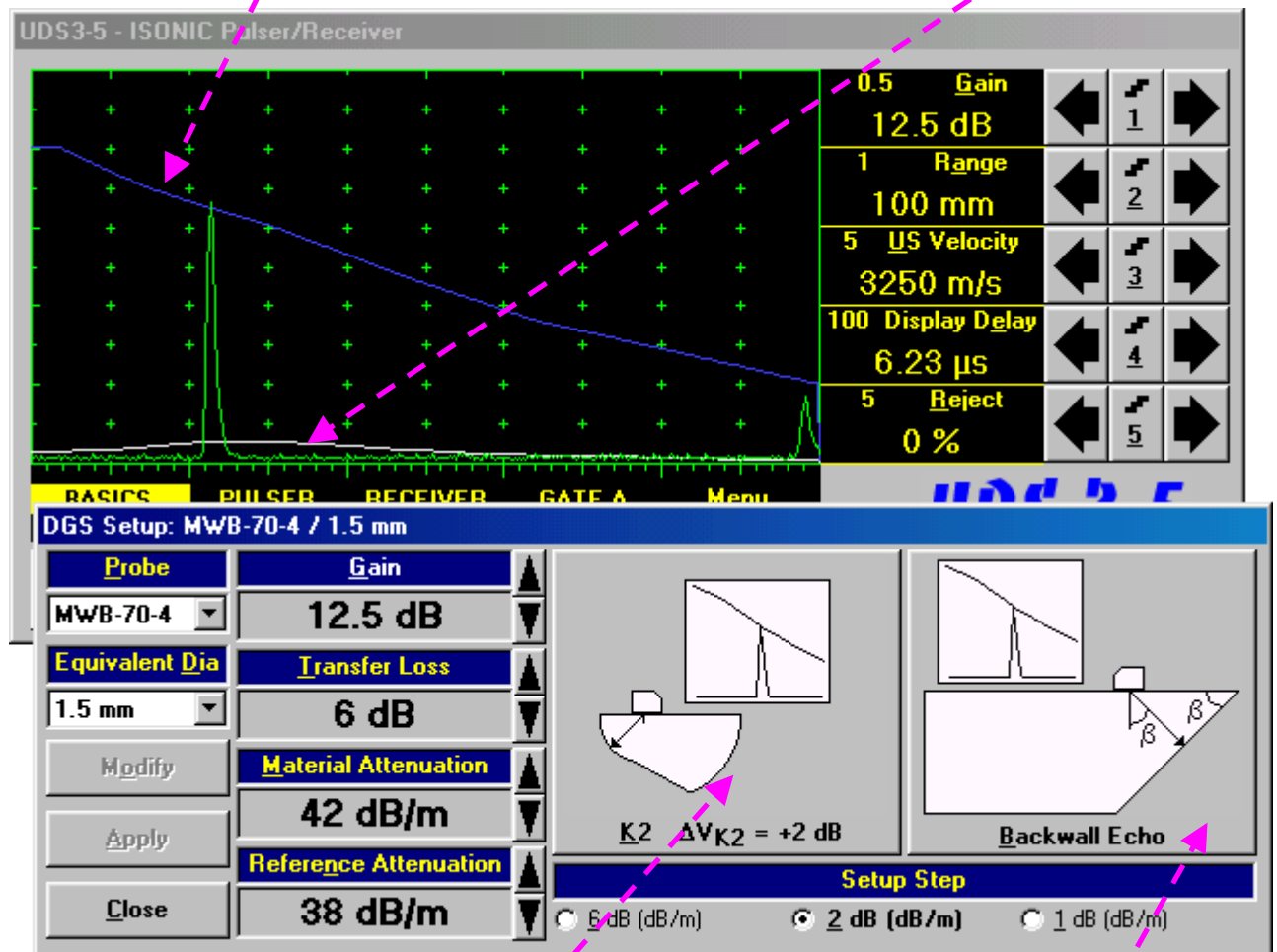

To finalize the **DGS** curve the following manipulations are applicable:

**Case 1 (K1 or K2 reference block)**

- **Mouse / Touch Screen**
  - Click **on**
- **Keyboard**
  - Pressing **<Alt>+<K>** on external keyboard

**Case 2 (Inclined reference block)**

- **Mouse / Touch Screen**
  - Click **on**
- **Keyboard**
  - Pressing **<Alt>+<B>** on external keyboard

The finalized **DGS** curve appears upon accompanied with *Automatic Gain Correction*:

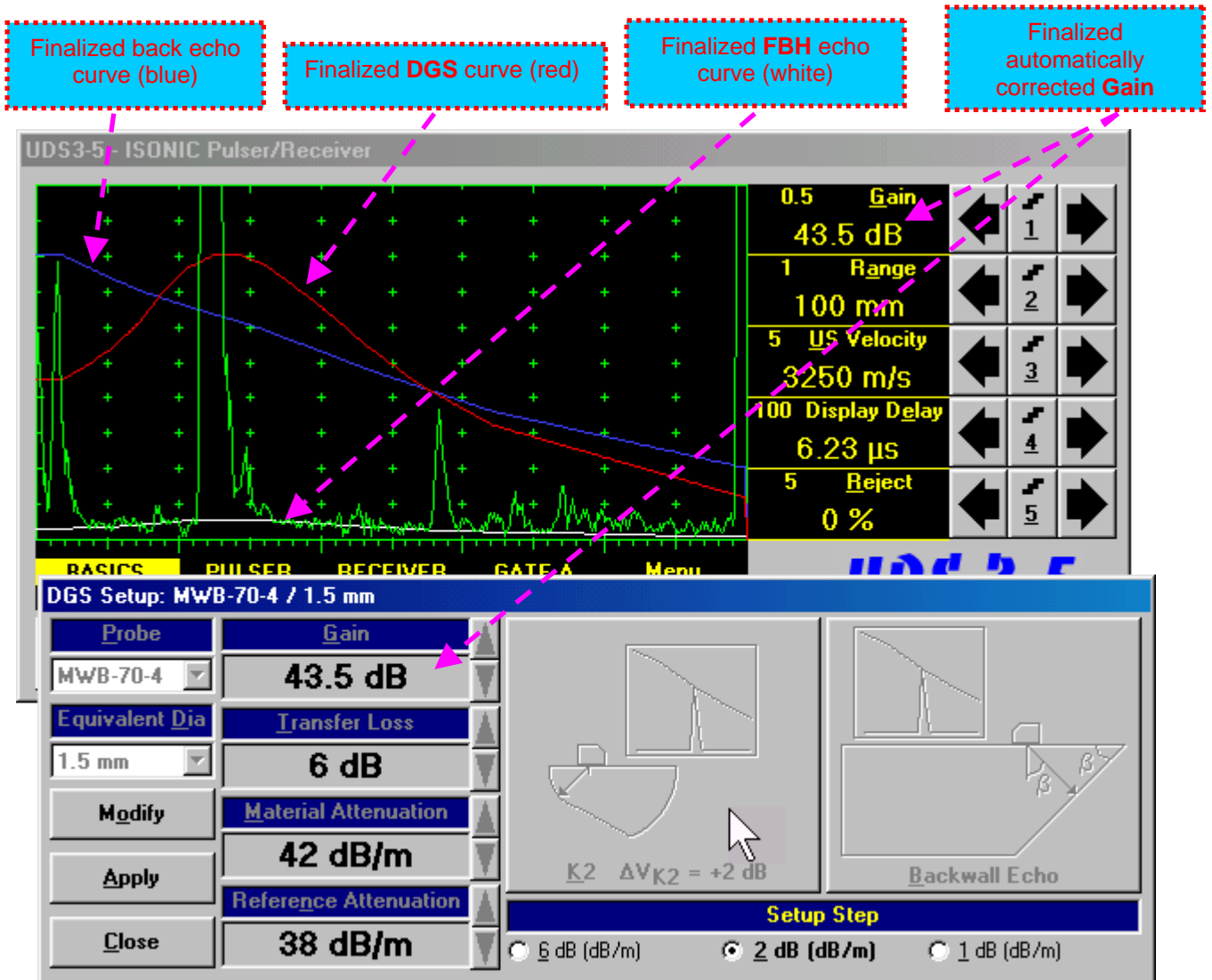

To accept finalized **DGS** curve and return to the main operating surface the following manipulations are applicable:

- **Mouse / Touch Screen**

- Click on 

then

- Click on 

- **Keyboard**

- Press <Alt>+<A> on external keyboard, then  or <Alt>+<C> or  on front panel keyboard



To negate the finalized **DGS** curve and return to main **UDS3-5** window the following manipulations are applicable:

- **Mouse / Touch Screen**

- Click on 

then

- Click on 

- **Keyboard**

- Press **<Alt>+<O>** on external keyboard, then  or **<Alt>+<C>** or  on front panel keyboard

To create new **DGS** curve the following manipulations are applicable:

- **Mouse / Touch Screen**

- Click on 

- **Keyboard**

- Press **<Alt>+<O>** on external keyboard

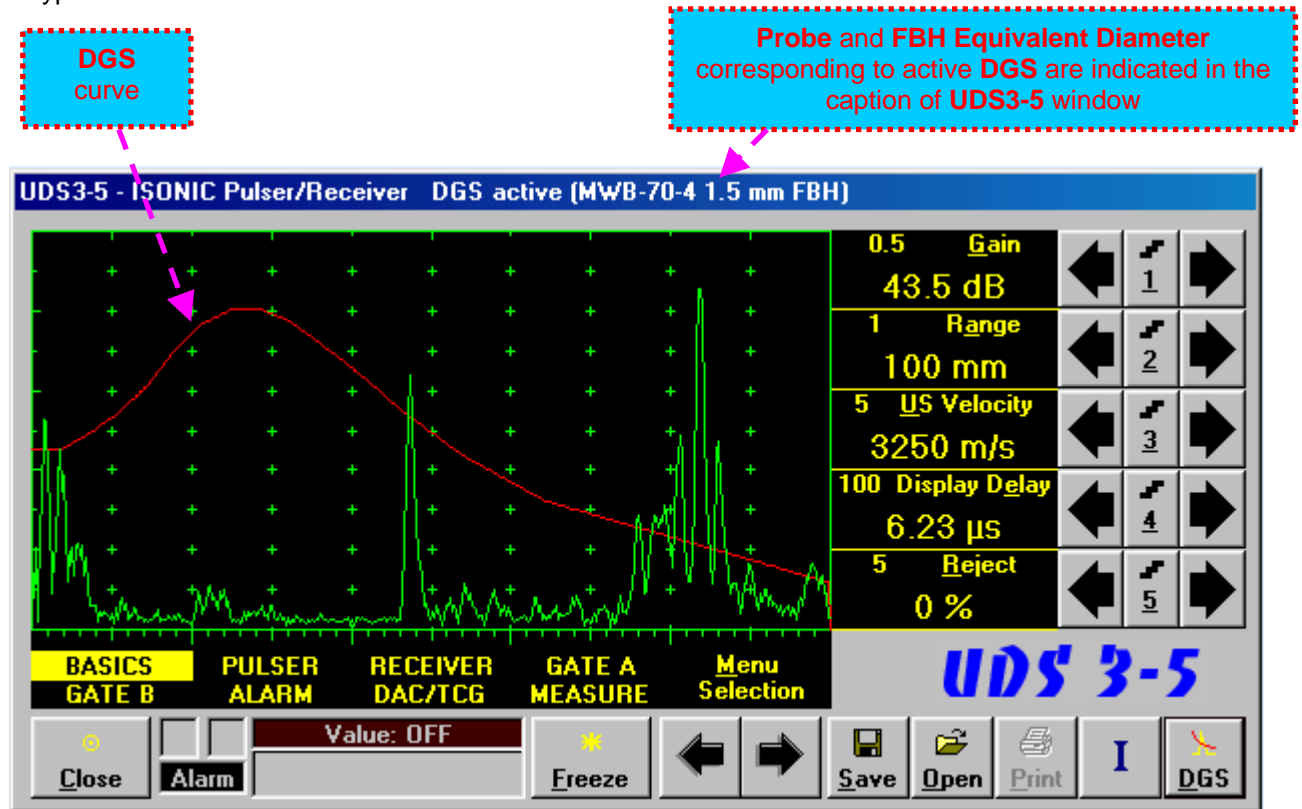

**Step 8: Work whilst DGS is active**

A typical screenshot with active **DGS** is shown below

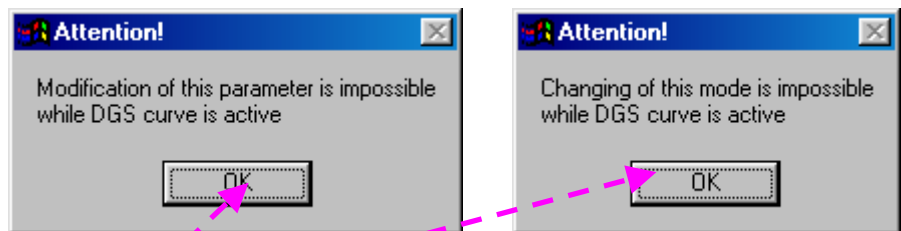

Some parameters and modes may not be modified whilst **DGS** is active - corresponding messages appear if attempting to modify:



To continue operation click on the **button** after message appears or press  or  on front panel keyboard or **Esc** or **Enter** on external keyboard

To negate the active **DGS** or create a new one click on  or press  on front panel keyboard or **F9** or **<Alt>+<D>** on external keyboard

## 5.2.12. Sub Menu MEASURE

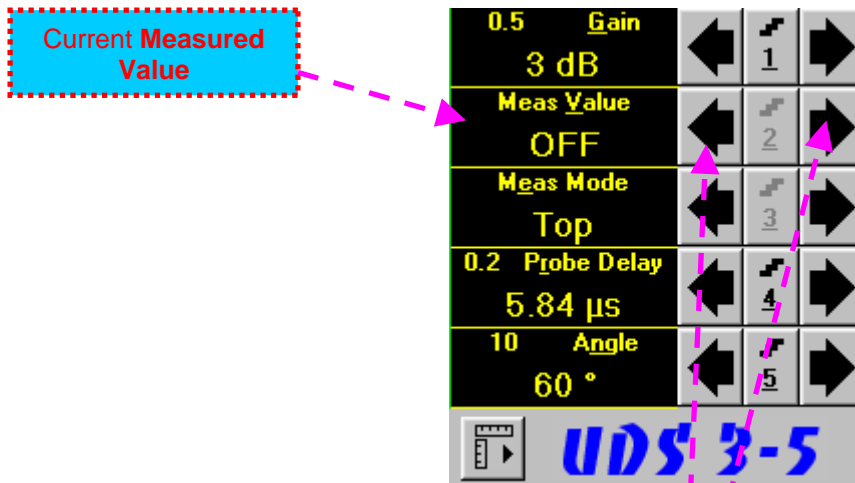









To select **Measured Value** the following manipulations are applicable:









- **Mouse / Touch Screen**

- Click or press and hold on the appropriate **button**

- **Keyboard**

- Press  on front panel keyboard or **F2** or **<Alt>+<V>** on external keyboard ⇒ **Meas Value** fore color changes to white - then use , , ,  on front panel keyboard or , , ,  on external keyboard

- **Combined**

- Click on **Meas Value** ⇒ **Meas Value** fore color changes to white - then use , , ,  on front panel keyboard or , , ,  on external keyboard



Refer to paragraph 5.2.13 of this Operating Manual for information about values available for automatic measurement and indication in the **Value Box (Digital Readout)**

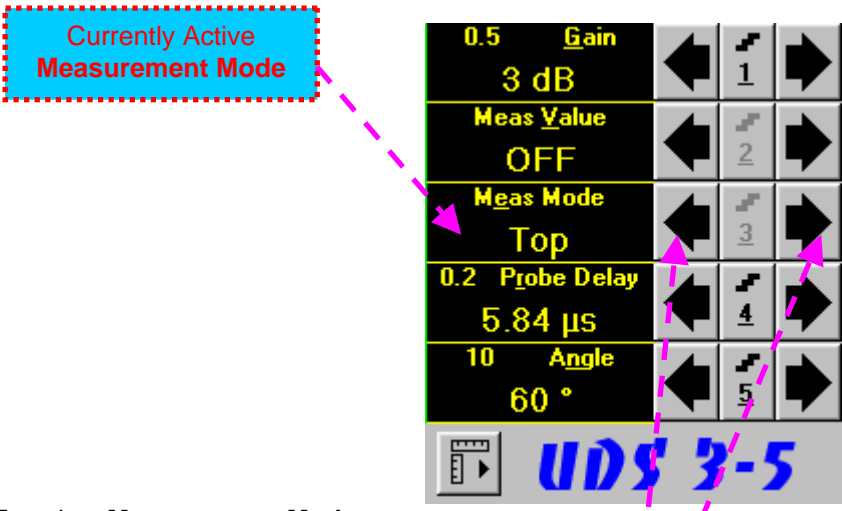

To select **Measurement Mode** the following manipulations are applicable:

- **Mouse / Touch Screen**
  - Click or press and hold on the appropriate button
- **Keyboard**
  - Press 3 on front panel keyboard or **F3** or **<Alt>+<E>** on external keyboard ⇒ **Meas Mode** fore color changes to white - then use ↑, →, ←, ↓ on front panel keyboard or ↑, →, ←, ↓ on external keyboard
- **Combined**
  - Click on **Meas Mode** ⇒ **Meas Mode** fore color changes to white - then use ↑, →, ←, ↓ on front panel keyboard or ↑, →, ←, ↓ on external keyboard

**i**

There are four Measurement Modes possible:

- ◆ Flank
- ◆ Top
- ◆ Flank-First
- ◆ Top-First

Refer to paragraph 5.2.13 of this Operating Manual for further information

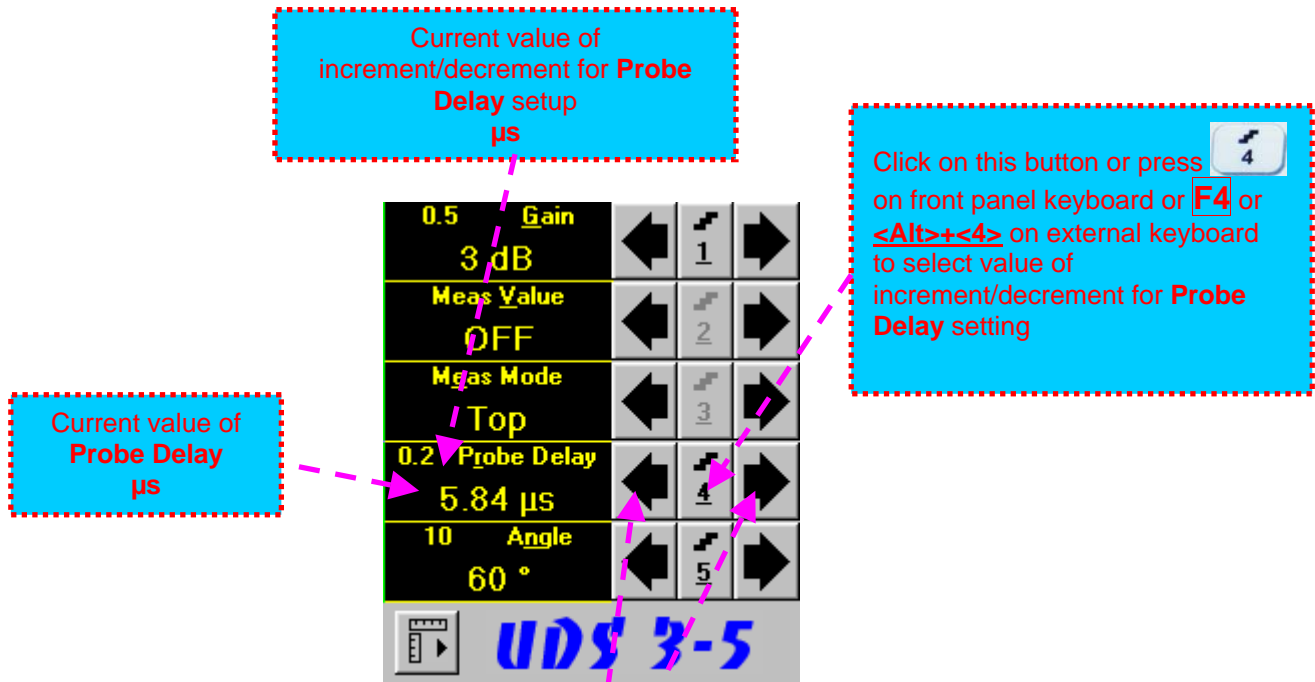









To control **Probe Delay** the following manipulations are applicable:









- **Mouse / Touch Screen**

- Click or press and hold on the appropriate **button**

- **Keyboard**

- Press  on front panel keyboard or **F4** or **<Alt>+<R>** on external keyboard  $\Rightarrow$  **Probe Delay** fore color changes to white - then use , , ,  on front panel keyboard or , , ,  on external keyboard

- **Combined**

- Click on **Probe Delay**  $\Rightarrow$  **Probe Delay** fore color changes to white - then use , , ,  on front panel keyboard or , , ,  on external keyboard

 Refer to paragraph 5.2.13 of this Operating Manual for some hints on determining **Probe Delay**

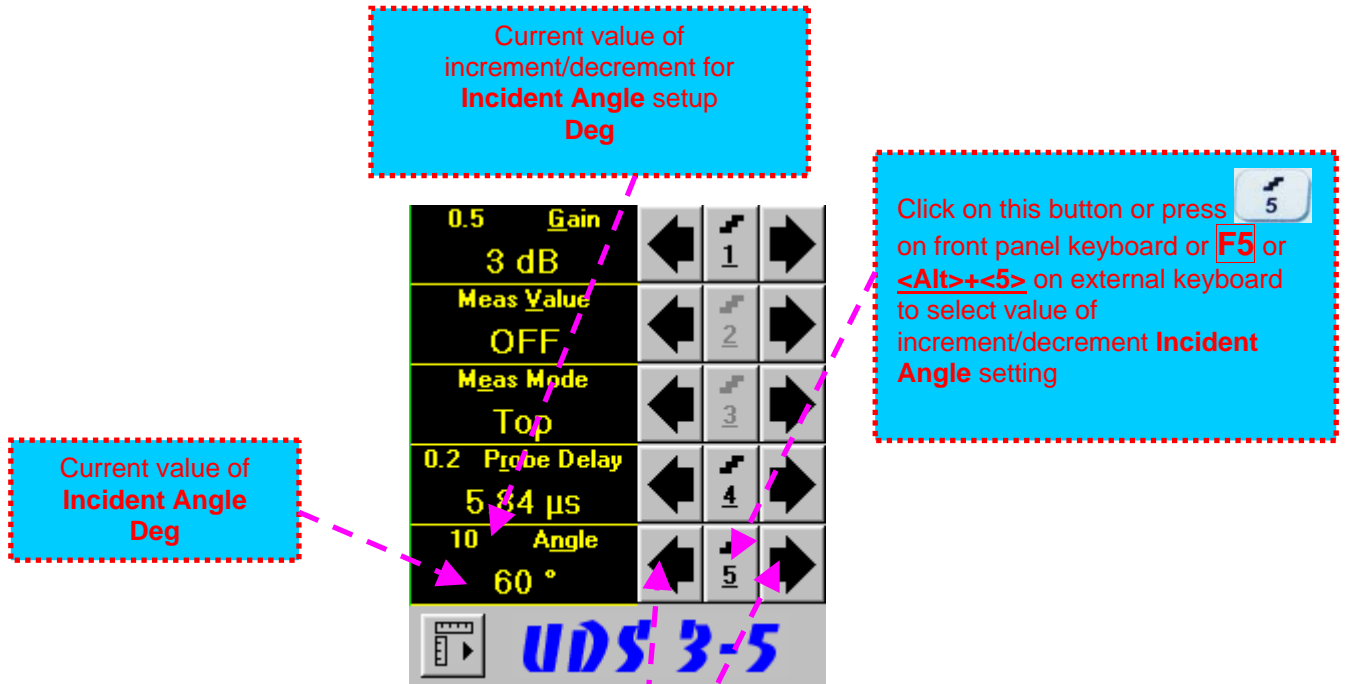









To control **Incident Angle** the following manipulations are applicable:









- **Mouse / Touch Screen**

- Click or press and hold on the appropriate  button

- **Keyboard**

- Press  on front panel keyboard or **F5** or **<Alt>+<N>** on external keyboard ⇒ **Angle** fore color changes to white - then use , , ,  on front panel keyboard or , , ,  on external keyboard

- **Combined**

- Click on **Angle** ⇒ **Angle** fore color changes to white - then use , , ,  on front panel keyboard or , , ,  on external keyboard







Refer to paragraph 5.2.13 of this Operating Manual for some hints on determining and / or checking **Probe Angle**

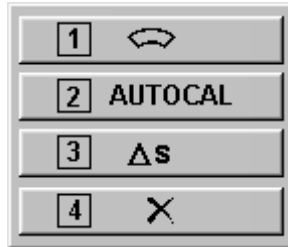

## Advanced Measurements Settings Menu



Advanced measurement settings are available through button  appearing on the **UDS 3-5** main operating surface upon activating submenu **MEASURE**. Clicking on that button activates Advanced Measurements Settings Menu:



Press  on front panel keyboard or **F1** on external keyboard or click on  to activate **Advanced Scheme for Reflectors Depth Measurement Whilst Using Angle Beam Probe – Thickness / Skip / Curved Scanning Surface Correction**

Press  on front panel keyboard or **F2** on external keyboard or click on  to activate **Automatic Calibration Procedure**

Press  on front panel keyboard or **F3** on external keyboard or click on  to activate **Dual Ultrasound Velocity Measurement Mode**

Press  or  on front panel keyboard or **F3** on external keyboard or click on  to return to main operating surface



Refer to paragraph 5.2.13.3 of this Operating Manual to get instructed on:

- ◆ **Advanced Scheme for Reflectors Depth Measurement Whilst Using Angle Beam Probe – Thickness / Skip / Curved Scanning Surface Correction**
- ◆ **Automatic Calibration Procedure**
- ◆ **Dual Ultrasound Velocity Measurement Mode**

## 5.2.13. Time Domain Signal Evaluation - Measurements Guide

### 5.2.13.1. Values available for Automatic Measurements and Digital Readout

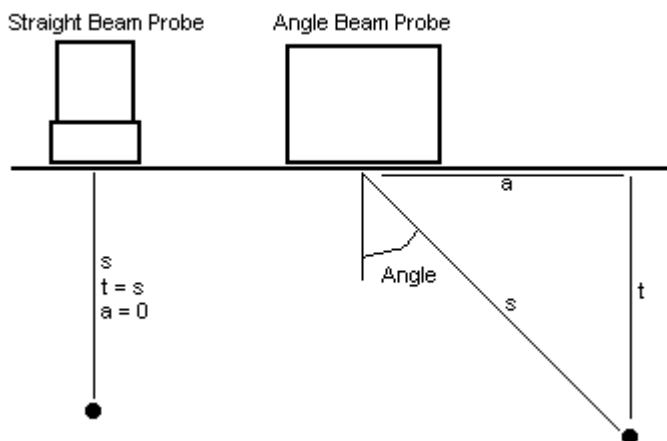
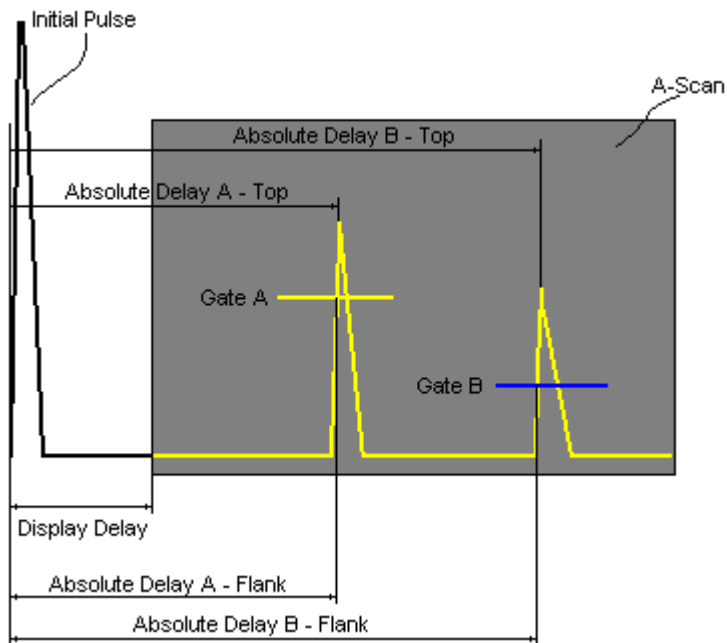

#### Value 1: T(A)

**Time of Flight** -  $\mu\text{s}$  of an echo matching with **Gate A** measured with respect to **Probe Delay**:

$$T(A) = \text{Absolute Delay A} - \text{Probe Delay}$$

#### Value 2: T(B)

**Time of Flight** -  $\mu\text{s}$  of an echo matching with **Gate B** measured with respect to **Probe Delay**:

$$T(B) = \text{Absolute Delay B} - \text{Probe Delay}$$

#### Value 3: s(A)

**Material Travel Distance** - mm or in of an echo matching with **Gate A**:

$$s(A) = \frac{1}{2} \cdot T(A) \cdot \text{US Velocity}$$

#### Value 4: s(B)

**Material Travel Distance** - mm or in of an echo matching with **Gate B**:

$$s(B) = \frac{1}{2} \cdot T(B) \cdot \text{US Velocity}$$

#### Value 5: a(A)

**Projection Distance** - mm or in of reflector returning an echo matching with **Gate A**, measured with respect to *Beam Incident Point*:

$$a(A) = s(A) \cdot \sin(\text{Angle})$$

#### Value 6: a(B)

**Projection Distance** - mm or in of reflector returning an echo matching with **Gate B**, measured with respect to *Beam Incident Point*:

$$a(B) = s(B) \cdot \sin(\text{Angle})$$

#### Value 7: t(A)

**Depth** - mm or in of reflector returning an echo matching with **Gate A**:

$$t(A) = s(A) \cdot \cos(\text{Angle})$$

#### Value 8: t(B)

**Depth** - mm or in of reflector returning an echo matching with **Gate B**:

$$t(B) = s(B) \cdot \cos(\text{Angle})$$

#### Value 9: $\Delta T$ - $\mu\text{s}$ :

$$\Delta T = T(B) - T(A)$$

#### Value 10: $\Delta s$ - mm or in:

$$\Delta s = s(B) - s(A)$$

#### Value 11: $\Delta a$ - mm or in:

$$\Delta a = a(B) - a(A)$$

#### Value 12: $\Delta t$ - mm or in:

$$\Delta t = t(B) - t(A)$$



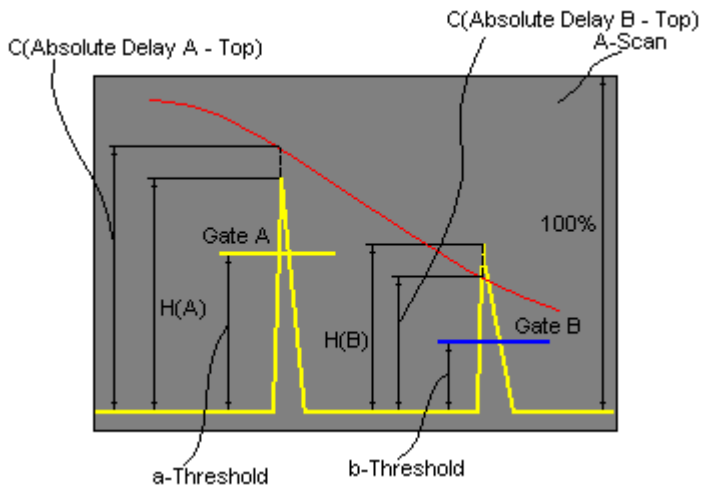

**Value 13: H(A)**

**Amplitude** - % of A-Scan height of an echo matching with **Gate A**

**Value 14: H(B)**

**Amplitude** - % of A-Scan height of an echo matching with **Gate B**

**Value 15: V(A)**

**Amplitude** - dB of an echo matching with **Gate A** with respect to **aThreshold**:

$$V(A) = 20 \cdot \log_{10} ( H(A) / aThreshold )$$

**Value 16: V(B)**

**Amplitude** - dB of an echo matching with **Gate B** with respect to **bThreshold**:

$$V(B) = 20 \cdot \log_{10} ( H(B) / bThreshold )$$

**Value 17:  $\Delta V$  - dB:**

$$\Delta V = V(B) - V(A)$$

**Value 18:  $\Delta VC(A)$  ( dB to DAC ) - dB:**

$$\Delta VC(A) = 20 \cdot \log_{10} ( H(A) / C (Absolute Delay A\_Top) )$$

**Value 19:  $\Delta VC(B)$  ( dB to DAC ) - dB:**

$$\Delta VC(B) = 20 \cdot \log_{10} ( H(B) / C (Absolute Delay B\_Top) )$$



- ◆ To proceed corresponding **Gate** or both **Gates** to be active
- ◆  $\Delta VC(A)$  (dB to DAC) measurements require active **DAC/DGS**
- ◆ Amplitude measurements of echoes may be performed provided their heights don't exceed 200% of **A-Scan** height
- ◆ For 2 and more echoes matching with a **Gate** - refer to paragraph 5.2.13.2 of this Operating Manual

### 5.2.13.2. Flank, Top, Flank-First, and Top-First Modes of Measurement

The table below represents distinguishing points on an **A-Scan**, which will be taken for automatic measurements depending on **Meas Mode** setting

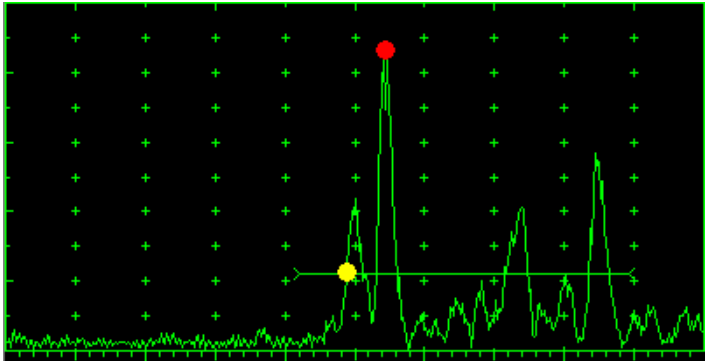
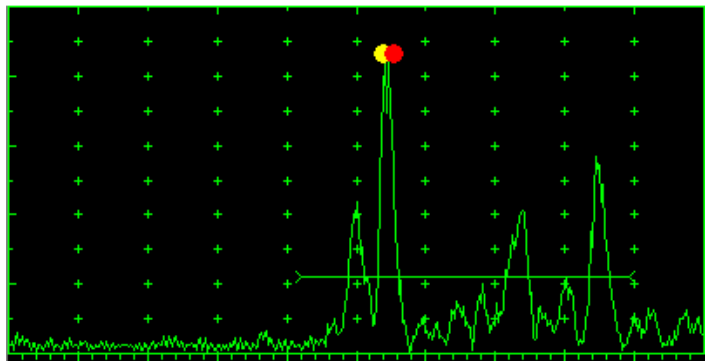
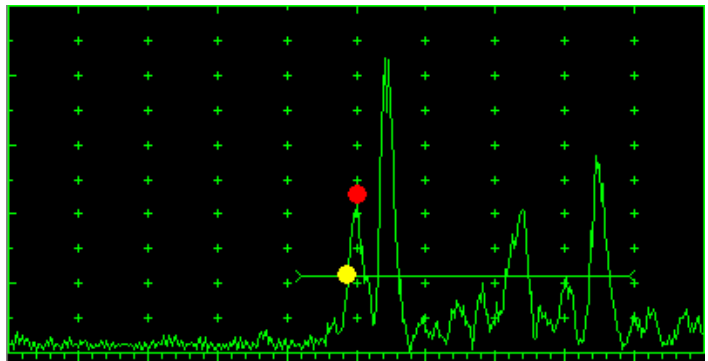
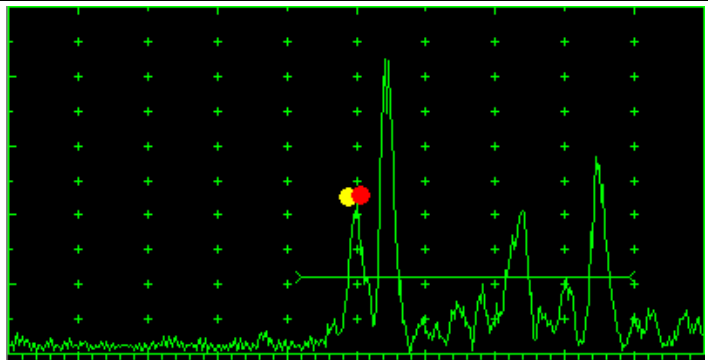



| Meas Mode setting   | A-Scan   |
|---|--|
| <p style="text-align: center;"><b>Meas Mode</b><br/><b>Flank</b></p> <p>● - T(A), T(B), s(A), s(B), t(A), t(B), a(A), a(B), ΔT, Δs, Δt, Δa<br/>● - V(A), V(B), H(A), H(B), ΔV, ΔVC(A), ΔVC(B)</p>       |    |
| <p style="text-align: center;"><b>Meas Mode</b><br/><b>Top</b></p> <p>● - T(A), T(B), s(A), s(B), t(A), t(B), a(A), a(B), ΔT, Δs, Δt, Δa<br/>● - V(A), V(B), H(A), H(B), ΔV, ΔVC(A), ΔVC(B)</p>         |   |
| <p style="text-align: center;"><b>Meas Mode</b><br/><b>Flank-First</b></p> <p>● - T(A), T(B), s(A), s(B), t(A), t(B), a(A), a(B), ΔT, Δs, Δt, Δa<br/>● - V(A), V(B), H(A), H(B), ΔV, ΔVC(A), ΔVC(B)</p> |  |
| <p style="text-align: center;"><b>Meas Mode</b><br/><b>Top-First</b></p> <p>● - T(A), T(B), s(A), s(B), t(A), t(B), a(A), a(B), ΔT, Δs, Δt, Δa<br/>● - V(A), V(B), H(A), H(B), ΔV, ΔVC(A), ΔVC(B)</p>   |  |

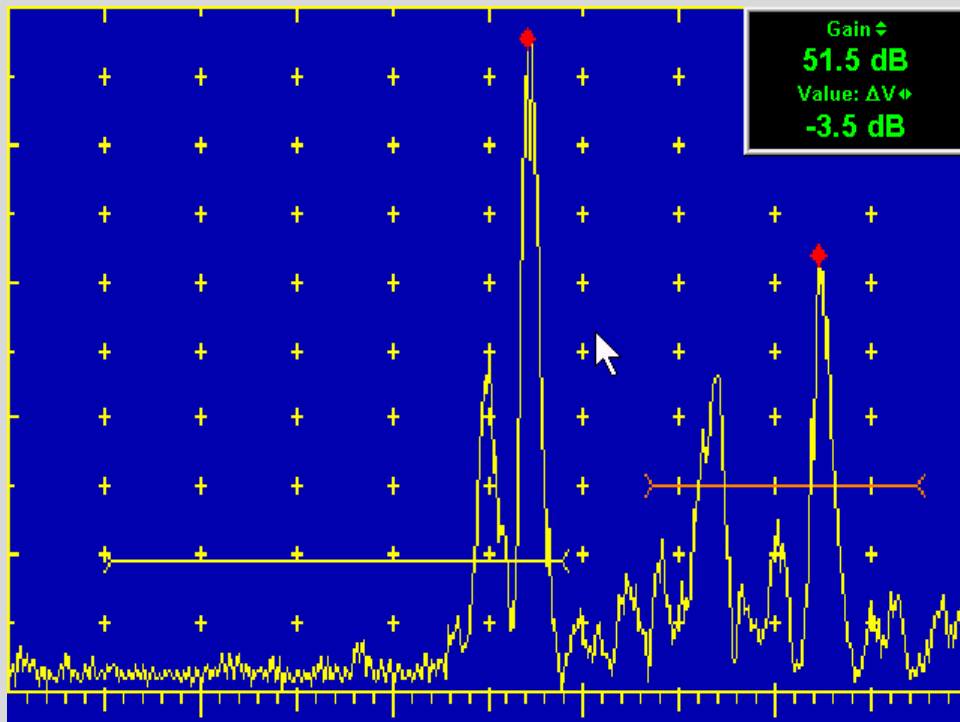
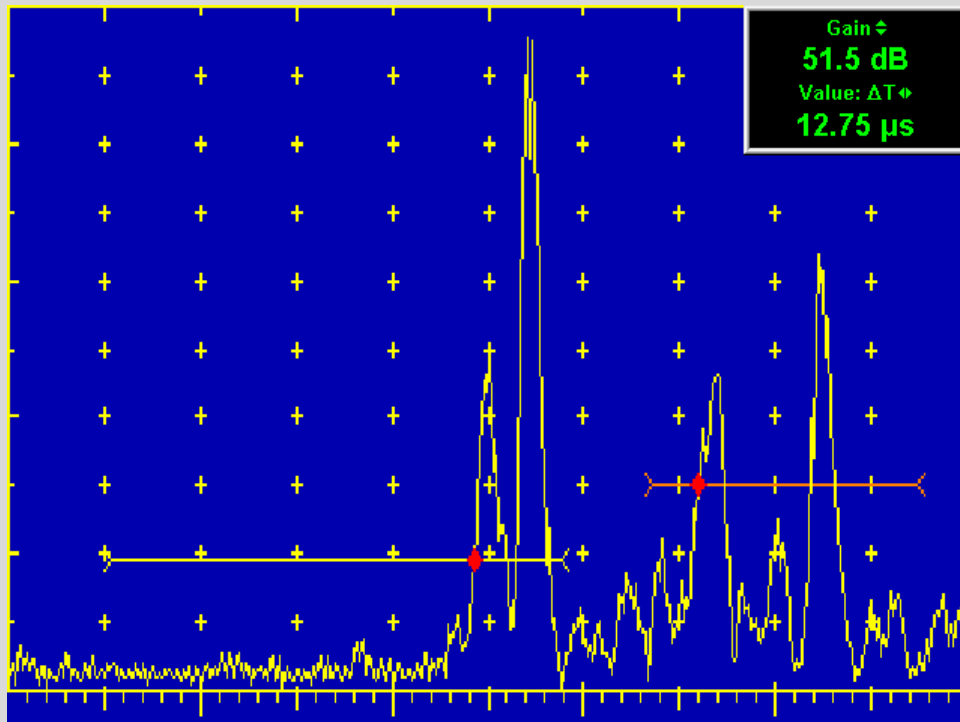

Distinguishing points of signals are automatically marked on A-Scan whilst measuring:



### 5.2.13.3. Advanced Scheme for Reflectors Depth Measurement Whilst Using Angle Beam Probe – Thickness / Skip / Curved Scanning Surface Correction

Button  becomes available upon clicking on  if **Angle** setting differs from 0° in submenu **MEASURE**. The window as below appears after clicking on  or pressing  on front panel keyboard or **F1** on external keyboard

Object under test may be designated as either

- **Flat** –  → 
- Or
- **Curved** –  → 

While scanning above plates, tube wall, and the like the finite thickness of object under test may be either

- **Ignored** –  → 
- Or
- **Entered** –  → 

**Case 1** represents simplest scheme supposing that scanning is performed above hemi-space whereas coordinates **t(A)**, **t(B)** are determined in accordance with appropriate sketches, equations, and **A-Scans** shown in paragraphs 5.2.13.1 and 5.2.13.2 of this Operating Manual

**Case 2** represents scanning above plate, or scanning above tubular object longitudinally. Reflectors depth for half skip, full skip, and multi skip insonification will be determined with respect to actual **Thickness** value – **t(A)**, **t(B)** readings will be in accordance with sketches below:

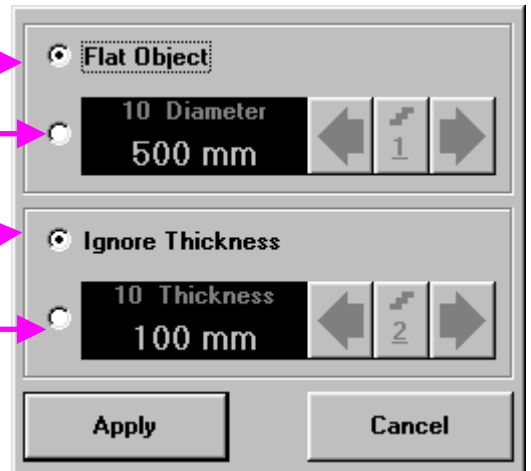
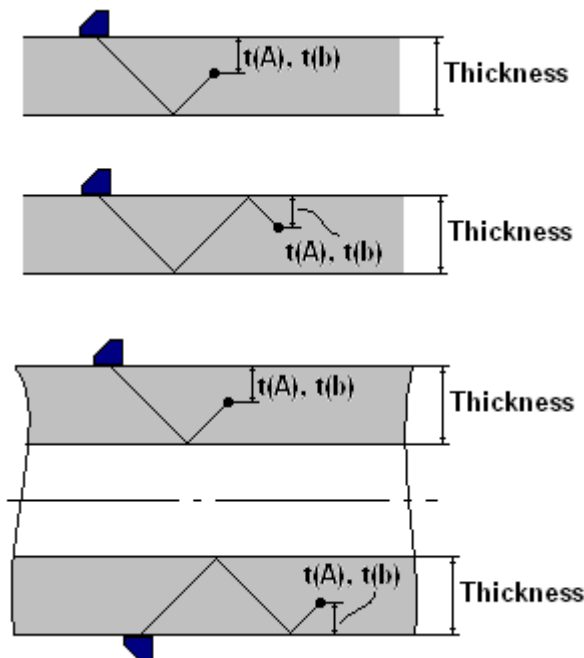

**Case 1**

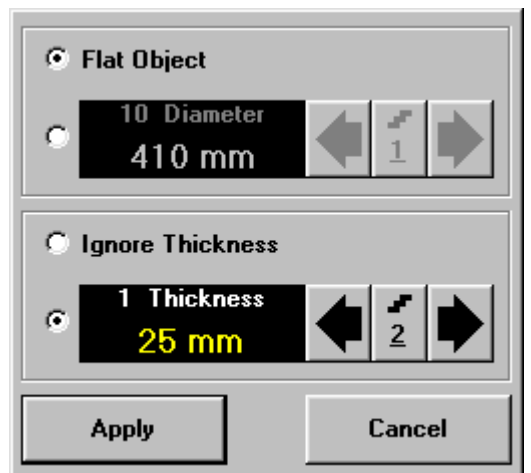

**Case 2**

**Case 3** represents scanning above curved wall surface circumferentially. Reflectors depth for half skip, full skip, and multi skip insonification will be determined with respect to actual **Thickness** and **Diameter** values – **t(A)**, **t(B)** readings will be in accordance with sketch below:

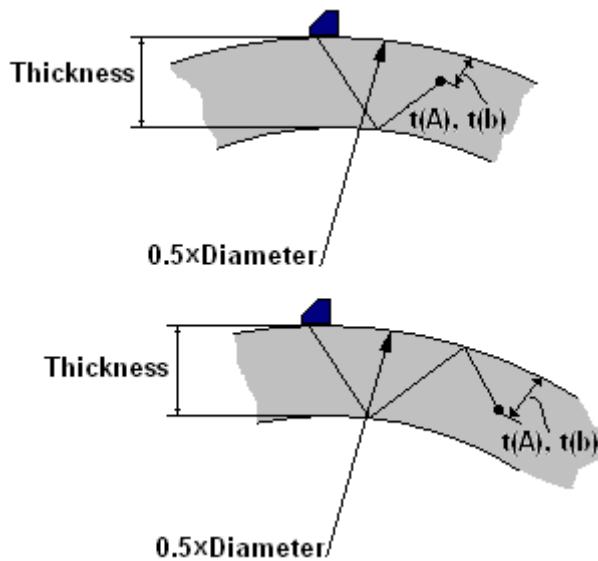

|  |             |        |   |   |
|--|-------------|--------|---|---|
| <input type="radio"/> Flat Object            | 10 Diameter | ←      | ↗ | → |
| <input checked="" type="radio"/> 10 Diameter | 400 mm      | ←      | 1 | → |
| <input type="radio"/> Ignore Thickness       | 1 Thickness | ←      | ↗ | → |
| <input checked="" type="radio"/> 1 Thickness | 9 mm        | ←      | 2 | → |
| Apply  |             | Cancel |   |   |

**Case 3**

**Case 4** represents scanning above solid cylindrical object circumferentially or above spherical object. If this is a case **Thickness** setting to be: **Thickness = 0.5 x Diameter** and reflectors depth will be determined with respect to actual **Diameter** value – **t(A)**, **t(B)** readings will be in accordance with sketch below:

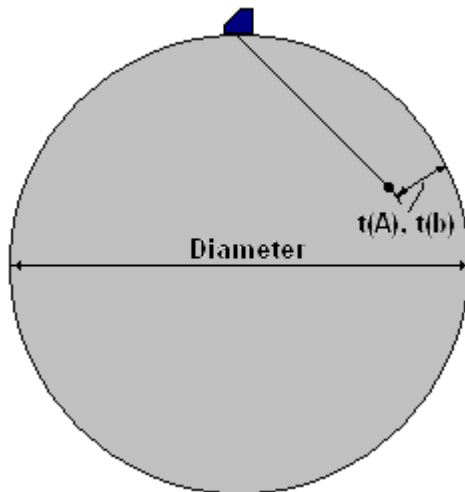

|   |              |        |   |   |
|---|--------------|--------|---|---|
| <input type="radio"/> Flat Object             | 2 Diameter   | ←      | ↗ | → |
| <input checked="" type="radio"/> 2 Diameter   | 254 mm       | ←      | 1 | → |
| <input type="radio"/> Ignore Thickness        | 50 Thickness | ←      | ↗ | → |
| <input checked="" type="radio"/> 50 Thickness | 127 mm       | ←      | 2 | → |
| Apply   |              | Cancel |   |   |

**Case 4**

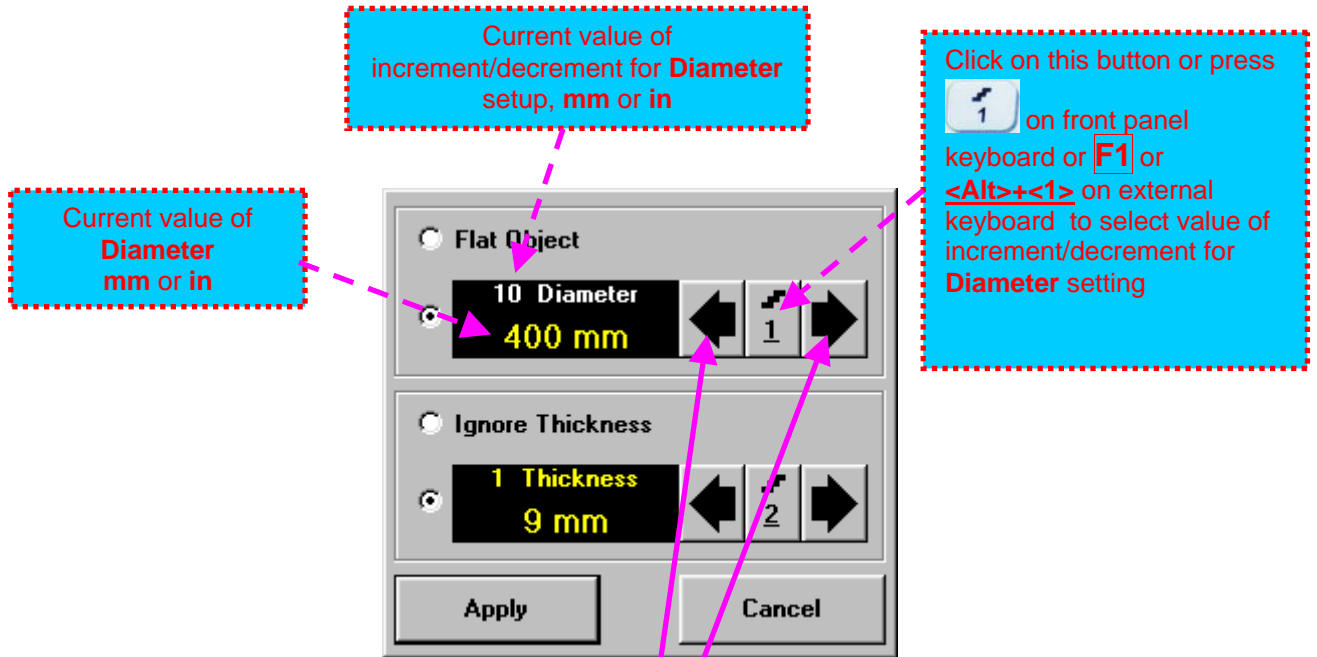

To control **Diameter** the following manipulations are applicable:

- **Mouse / Touch Screen**

- Click or press and hold on the appropriate button

- **Keyboard**

- Press on front panel keyboard or **F1** on external keyboard ⇒ **Diameter** fore color changes to white - then use , , , on front panel keyboard or , , , on external keyboard

- **Combined**

Click on **Diameter** ⇒ **Diameter** fore color changes to white - then use , , , on front panel keyboard or , , , on external keyboard

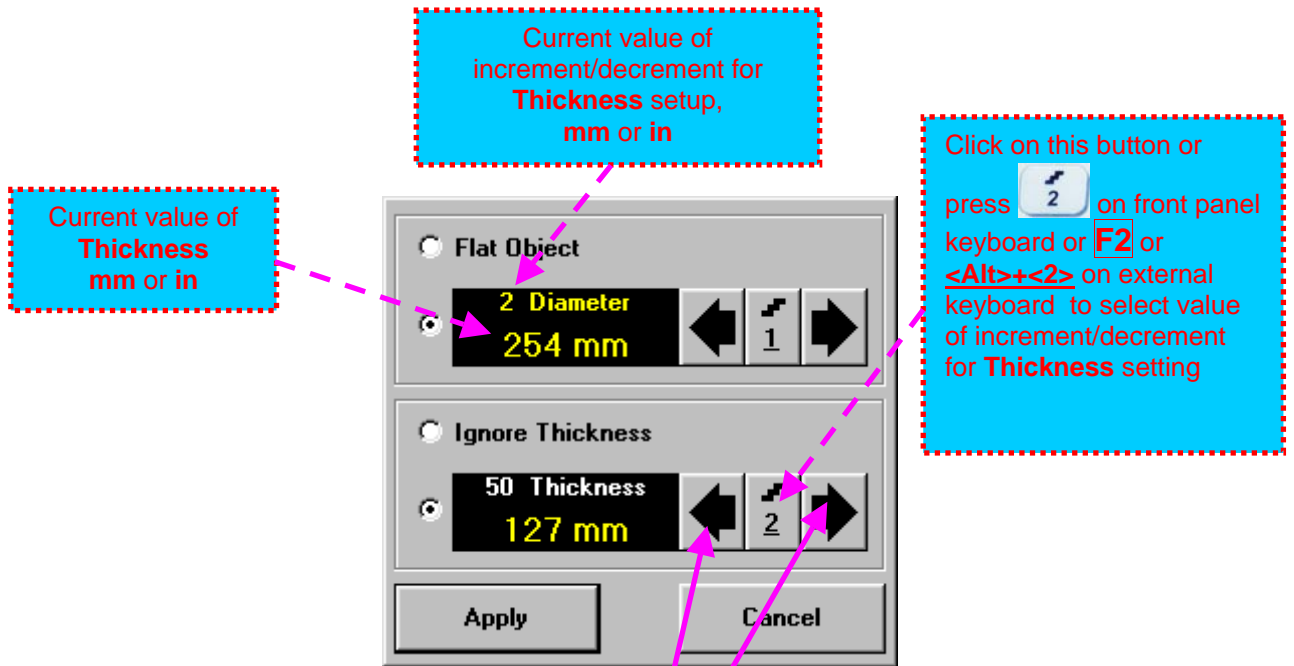

To control **Thickness** the following manipulations are applicable:

- **Mouse / Touch Screen**

- Click or press and hold on the appropriate button

- **Keyboard**

- Press 2 on front panel keyboard or **F2** on external keyboard ⇒ **Thickness** fore color changes to white - then use ↑, →, ←, ↓ on front panel keyboard or ↑, →, ←, ↓ on external keyboard

- **Combined**

- Click on **Thickness** ⇒ **Thickness** fore color changes to white - then use ↑, →, ←, ↓ on front panel keyboard or ↑, →, ←, ↓ on external keyboard



- ◆ Click on Apply or press Enter on front panel keyboard or Enter on external keyboard to activate new settings
- ◆ Click on Cancel or press ESC on front panel keyboard or Esc on external keyboard to negate new settings

### 5.2.13.4. Dual Ultrasound Velocity Measurement Mode – Typical Example

For some practical applications it is necessary to measure sound path distances in dissimilar materials, multi-layer structures, and the like. Also it may occur a need in measuring sound path distances for signals representing various kinds of ultrasonic waves in the same object. Such cases are characterized by variety of **US Velocity** values to be used while measuring intervals between signals on the same **A-Scan**. To simplify measurement procedure and avoid operator's computations it may be activated **Dual Ultrasound Velocity Measurements Mode**, which's use is illustrated by the example below

Supposing it's necessary to measure thickness of each layer of bi-metallic part made through by means of explosion welding between regular carbon steel ( **US Velocity = 5920 m/s** ) and brass alloy ( **US Velocity = 4720 m/s** ) plates while probe to be placed on low carbon steel plate. While placed on the steel side 10 MHz dual element probe with **Probe Delay = 5.8 μs** receives two clear echoes **1** and **2** from the *steel-to-brass boundary* and from the *back surface of the brass layer* correspondingly:

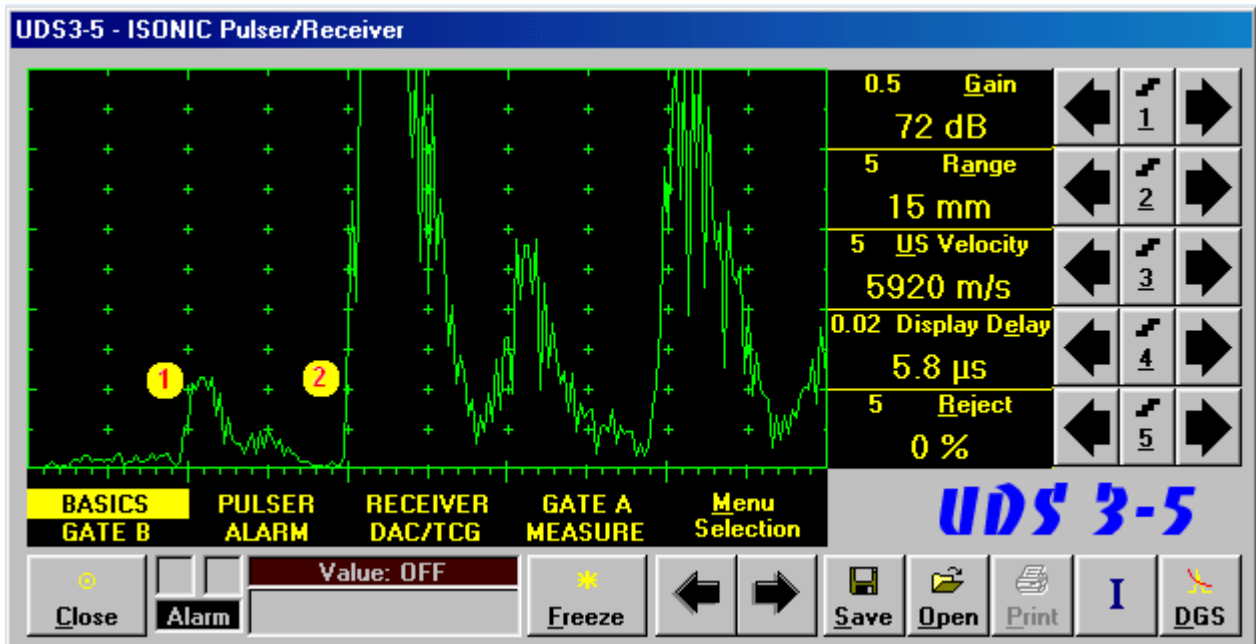
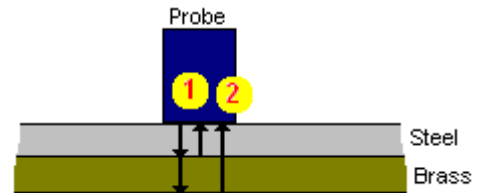

**US Velocity** setting is suitable for steel and thickness of steel layer may be found through direct reading upon placing **Gate A** above signal 1:

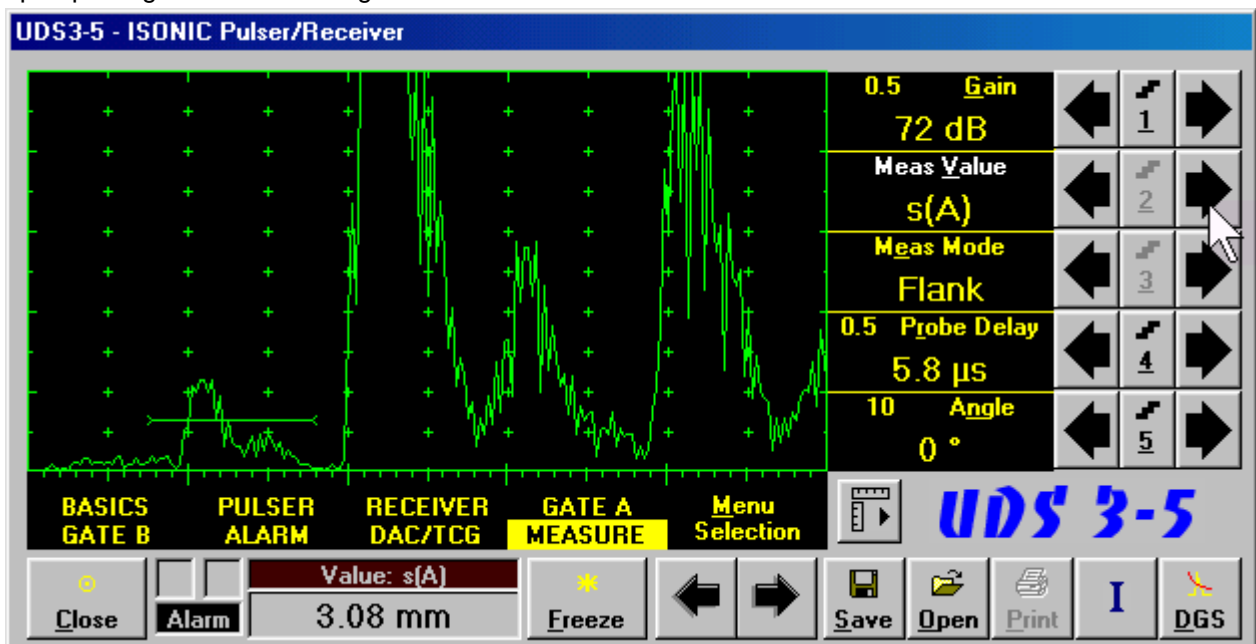



If placing now **Gate B** above signal 2 and selecting  $\Delta s$  as **Meas Value** then interval between signals 1 and 2 will be measured. To obtain proper  $\Delta s$  readout value of **US Velocity** valid for brass alloy layer (second material) must be keyed in

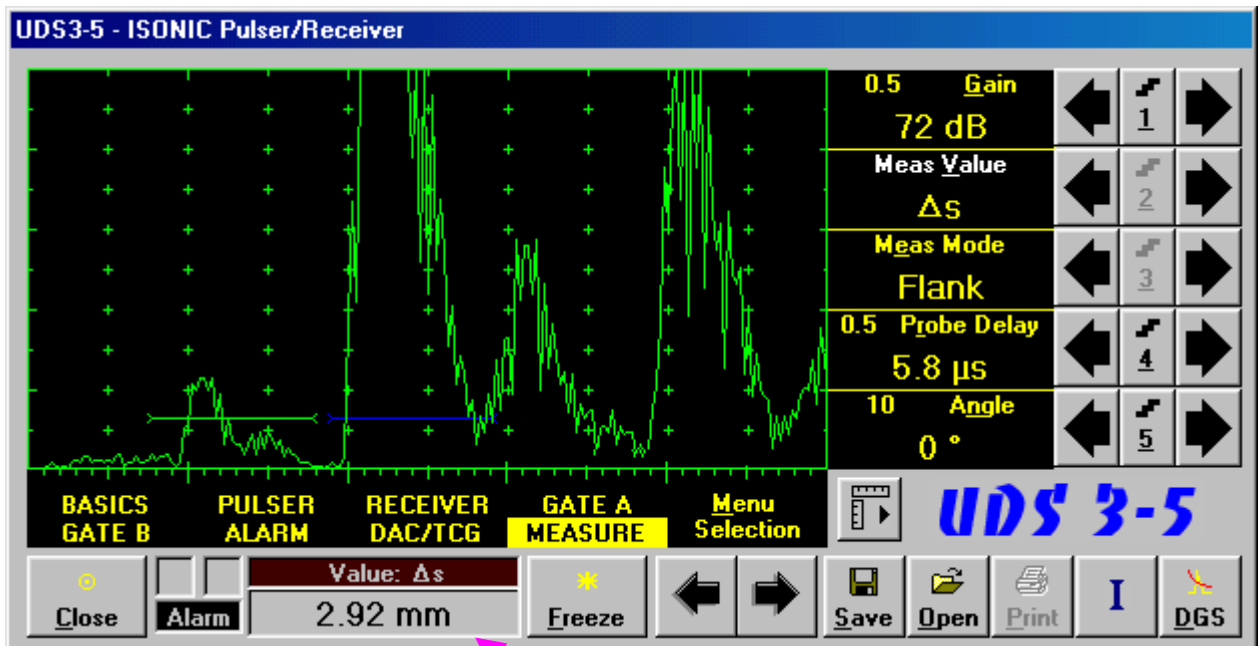



This digital readout was obtained through use of steel **US Velocity** setting (first material) and may not be recognized as a thickness of brass alloy layer (second material)

To obtain proper reading for the thickness of brass layer activate **Dual Ultrasound Velocity Measurements**

**Mode** - Button **3 Δs** becomes available upon clicking on **Menu Selection** if:

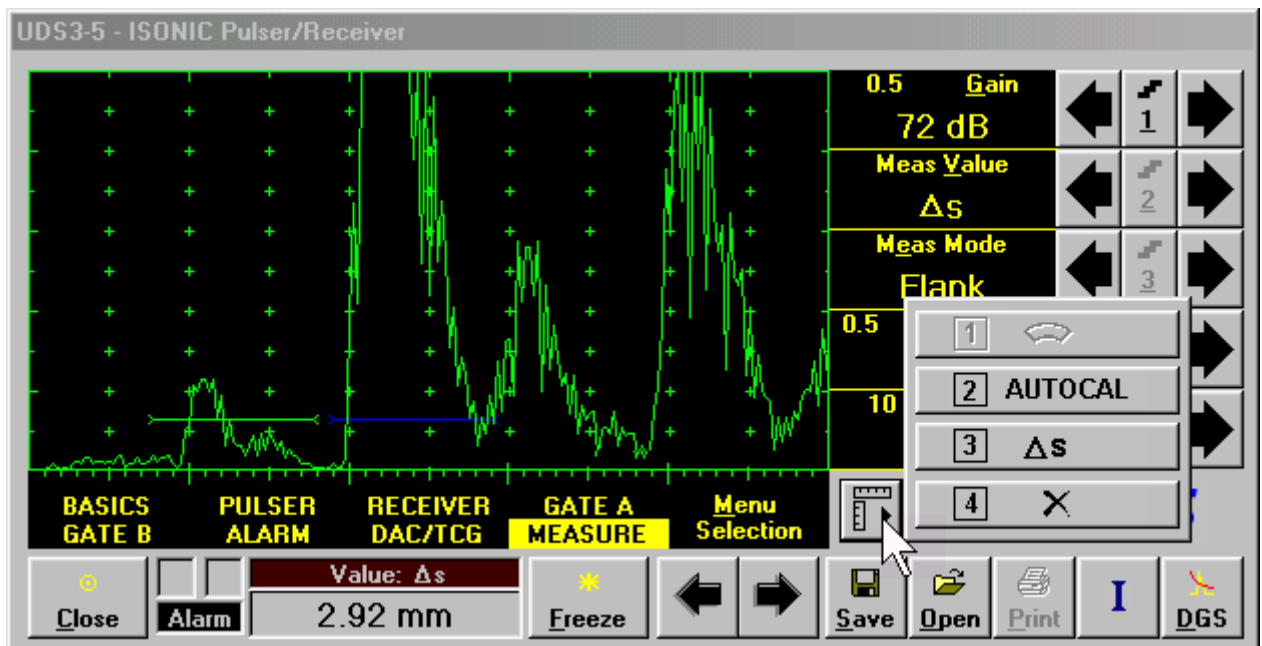
- ◆ Both **Gate A** and **Gate B** are active (refer to paragraphs 5.2.5 and 5.2.6 of this Operating Manual)
- ◆ **Meas Value** setting is  $\Delta s$  (refer to paragraph 5.2.12 of this Operating Manual)



The screen as below appears after clicking on  or pressing  on front panel keyboard or **F3** on external keyboard:

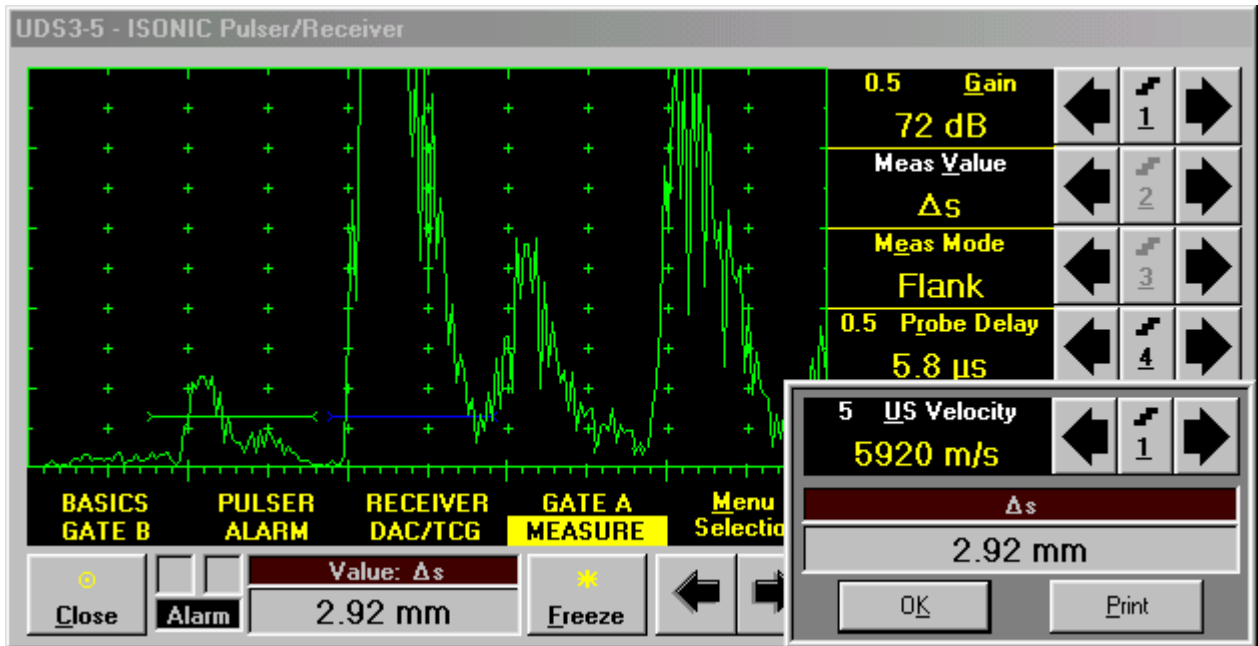

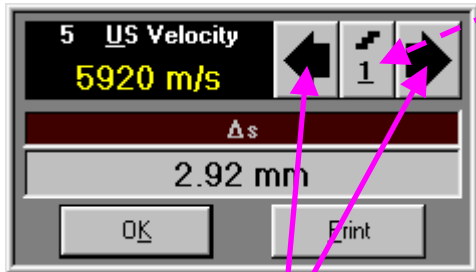

Click on this button or press  on front panel keyboard or **F1** or **<Alt>+<1>** on external keyboard to select value of increment/decrement for second **US Velocity** setting

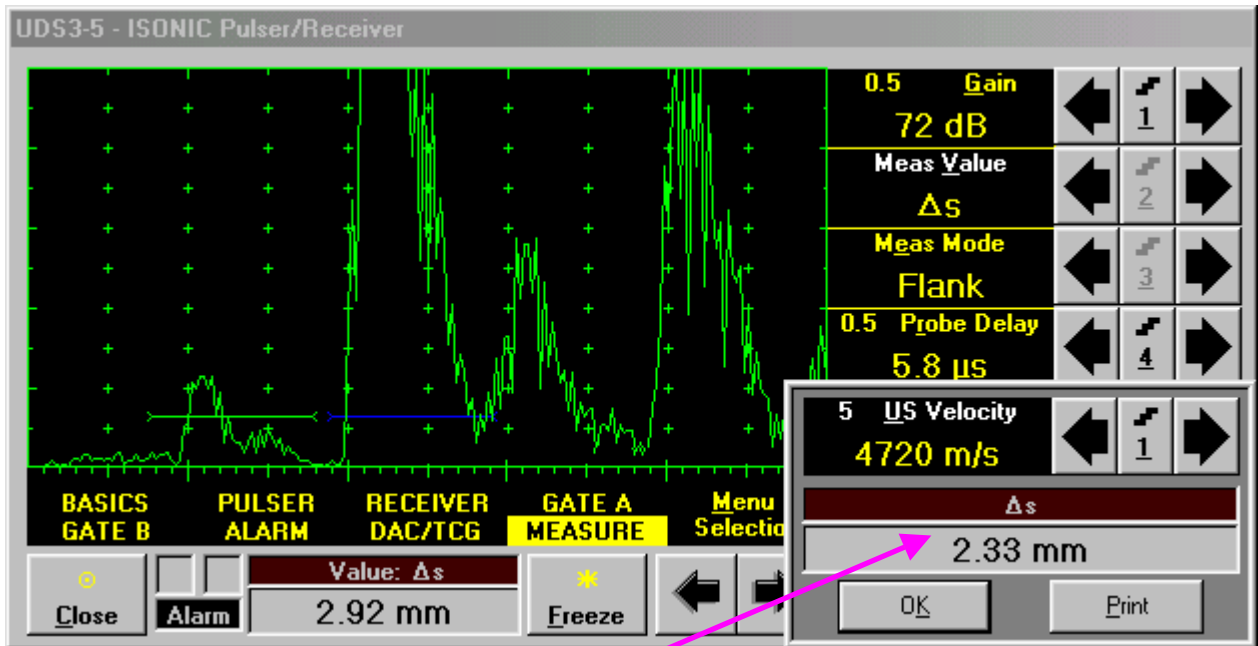

Click on appropriate  button or press , , ,  on front panel keyboard or , , ,  on external keyboard to setup value of second **US Velocity** valid for brass alloy layer (second material)

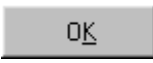

Digital readout for actual thickness of the brass alloy layer (second material) is obtained upon completing setting for second **US Velocity**

To return to the main **ISONIC Pulser Receiver** window click on  or press  or  on front panel keyboard or **<Alt>+<K>** or **Enter** or **Esc** on external keyboard

To printout **A-Scan** accompanied with setup list, measured value of  $\Delta s$ , and second **US Velocity** value click on  or press **<Alt>+<P>** on external keyboard (printer to be accessible through either USB or LAN port and defined as default in the **ISONIC 2007**)

### 5.2.13.5. Determining Probe Delay - Miniature Angle Beam Probes (contact face width 12.5 mm / 0.5 in or less) - Shear or Longitudinal Waves – Typical Example

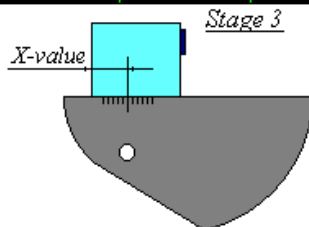
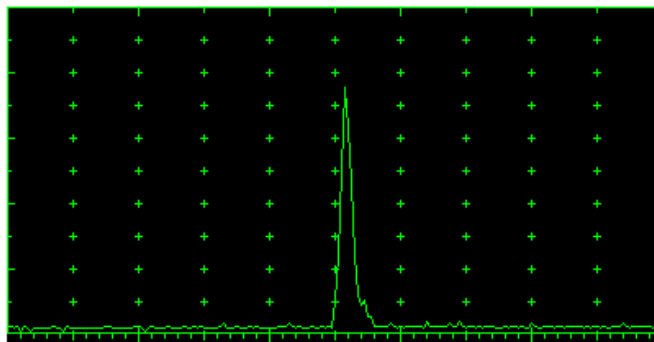
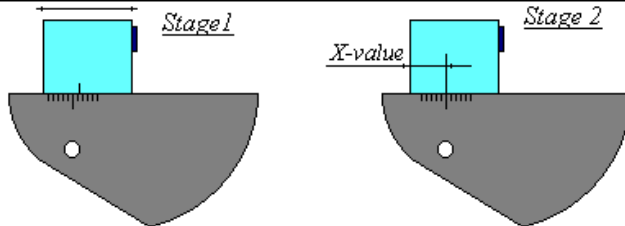
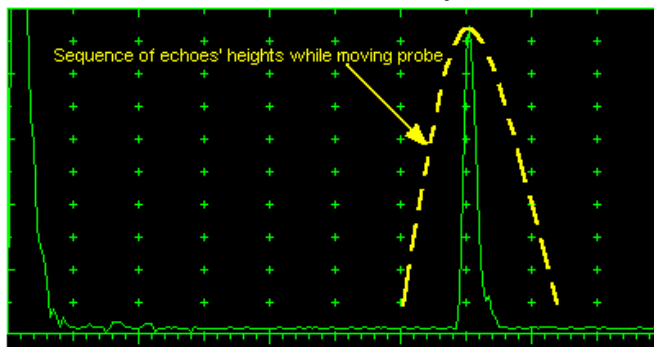

Activate submenu **PULSER** then set:

- Pulser Mode** to **Single** or **Dual** depending on probe
- Pulse Width** to **Spike (240 μJ)** for probe having resonant frequency of 8 MHz and higher or to **PW ns**, were  $PW = 0.5 / F$  (F is the probe resonant frequency) for probes having resonant frequency below 8 MHz
- Firing Level** to **18**
- Damping** to **1000 Ω**
- Tuning** to **NO**

Activate submenu **RECEIVER** then set:

- Display** to **Full** or **RF**
- Filter** to **BB**
- Frequency** to completely cover probe's effective bandwidth

Activate submenu **BASICS** topic then set:

- US Velocity** to **5920 m/s (233.1 in/ms)** for longitudinal wave probes or **3255 m/s (128.1 in/ms)** for shear wave probes
- Range** to **50.0 mm (2 in)**
- Display Delay** to **0 μs**
- Reject** to **0%**

**Stage 1:** Manipulate probe over main working surface of V-2 reference standard and maximize echo from 25 mm (1 in) radius concave reflector

**Stage 2:** Fix probe in found position - the center of 25 mm (1 in) radius concave reflector will indicate **incident point** while the distance between probe's frontal edge and **incident point** is equal to **X-Value**

**Stage 3:** Tune **Display Delay** while probe is still fixed in found position until rising edge of maximized echo will match with 50%-grid of the **A-Scan** width. Upon completing the *obtained value of Display Delay* will be equal to *actual Probe Delay*



- ◆ It's necessary to setup **Gain** bringing height of maximized echo to **75-80%** of **A-Scan** height
- ◆ It is recommended to optimize **Tuning** in **PULSER** submenu upon obtaining maximized echo. The goal of such optimization is increasing of ultrasonic excitation energy through better matching between firing output and probe. Level of ultrasonic excitation energy is clearly represented by echo amplitude. Upon completing **Tuning** optimization **Gain** to be adjusted to bring echo to **75-80%** of **A-Scan** height

### 5.2.13.6. Determining Probe Delay - Large and Medium Size Angle Beam Probes (contact face width more than 12.5 mm / 0.5 in) - Shear or Longitudinal Waves – Typical Example

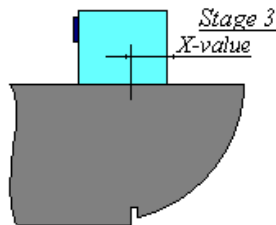
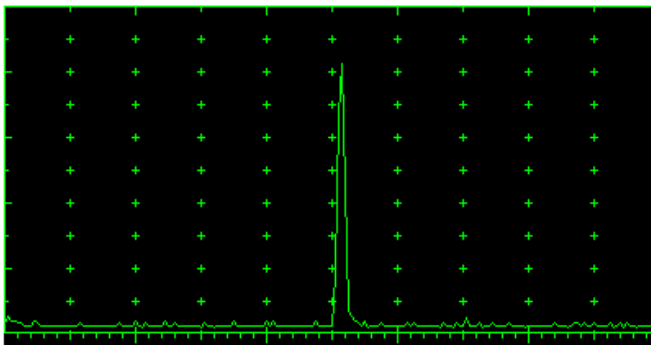
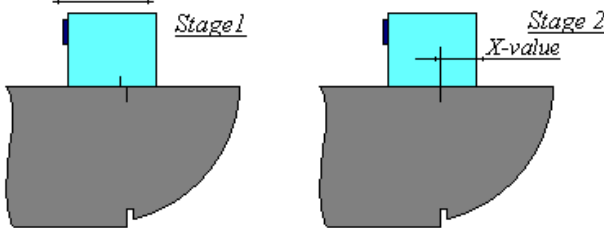
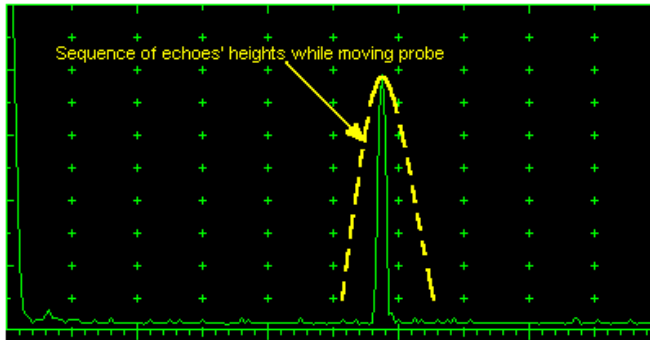

Activate submenu **PULSER** then set:

- Pulser Mode** to **Single** or **Dual** depending on probe
- Pulse Width** to **Spike (240 μJ)** for probe having resonant frequency of 8 MHz and higher or to **PW ns**, where  $PW = 0.5 / F$  (F is the probe resonant frequency) for probes having resonant frequency below 8 MHz
- Firing Level** to **18**
- Damping** to **1000 Ω**
- Tuning** to **NO**

Activate submenu **RECEIVER** then set:

- Display** to **Full** or **RF**
- Filter** to **BB**
- Frequency** to completely cover probe's effective bandwidth

Activate submenu **BASICS** topic then set:

- US Velocity** to **5920 m/s (233.1 in/ms)** for longitudinal wave probes or **3255 m/s (128.1 in/ms)** for shear wave probes
- Range** to **200.0 mm (8 in)**
- Display Delay** to **0 μs**
- Reject** to **0%**

**Stage 1:** Manipulate probe over main working surface of V-1 reference standard and maximize echo from 100 mm (4 in) radius concave reflector

**Stage 2:** Fix probe in found position - the center of 100 mm (4 in) radius concave reflector will indicate **incident point** while the distance between probe's frontal edge and **incident point** is equal to **X-Value**

**Stage 3:** Tune **Display Delay** while probe is still fixed in found position until rising edge of maximized echo will match with 50%-grid of the **A-Scan** width. Upon completing the *obtained value of Display Delay* will be equal to actual **Probe Delay**



- ◆ It's necessary to setup **Gain** bringing height of maximized echo to **75-80%** of **A-Scan** height
- ◆ It is recommended to optimize **Tuning** in **PULSER** submenu upon obtaining maximized echo. The goal of such optimization is increasing of ultrasonic excitation energy through better matching between firing output and probe. Level of ultrasonic excitation energy is clearly represented by echo amplitude. Upon completing **Tuning** optimization **Gain** to be adjusted to bring echo to **75-80%** of **A-Scan** height

### 5.2.13.7. Determining Probe Delay - Straight Beam (Normal) Single Element and Dual (TR) Probes – Typical Example

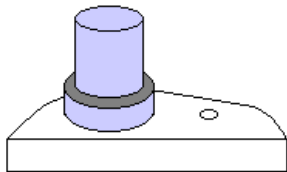
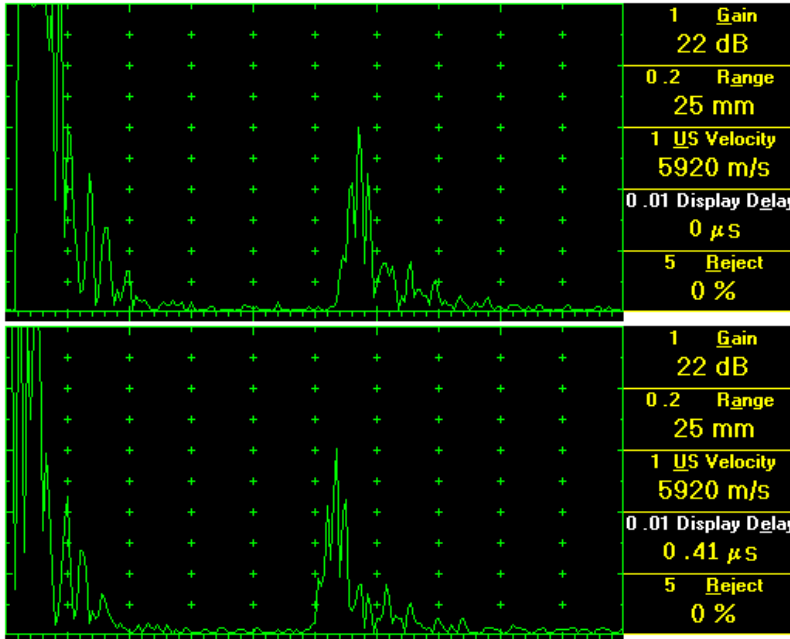

Activate submenu **PULSER** then set:

- Pulser Mode** to **Single** or **Dual** depending on probe
- Pulse Width** to **Spike (240 μJ)** for probe having resonant frequency of 8 MHz and higher or to **PW ns**, where **PW = 0.5 / F** (F is the probe resonant frequency) for probes having resonant frequency below 8 MHz
- Firing Level** to **18**
- Damping** to **1000 Ω**
- Tuning** to **NO**

Activate submenu **RECEIVER** then set:

- Display** to **Full** or **RF**
- Filter** to **BB**
- Frequency** to completely cover probe's effective bandwidth

Activate submenu **BASICS** topic then set:

- US Velocity** to **5920 m/s (233.1 in/ms)** for longitudinal wave probes or **3255 m/s (128.1 in/ms)** for shear wave probes
- Range** to **25.0 mm (1 in)**
- Display Delay** to **0 μs**
- Reject** to **0%**

**Stage 1:** Apply probe to a side surface of V-2 reference standard to receive back echo

**Stage 2:** Tune **Display Delay** until rising edge of the *back echo* will match with the 50%-grid of the **A-Scan** width: in such case the obtained value of the **Display Delay** is equal to the actual **Probe Delay**



- ◆ It's necessary to setup **Gain** bringing height of back echo to **75-80%** of **A-Scan** height
- ◆ It is recommended to optimize **Tuning** in **PULSER** submenu upon obtaining back echo. The goal of such optimization is increasing of ultrasonic excitation energy through better matching between firing output and probe. Level of ultrasonic excitation energy is clearly represented by back echo amplitude. Upon completing **Tuning** optimization **Gain** to be adjusted to bring echo to **75-80%** of **A-Scan** height

### 5.2.13.8. Automatic Calibration (AUTOCAL) of Probe Delay and US Velocity - Angle Beam Probes - Shear or Longitudinal Waves – Typical Example

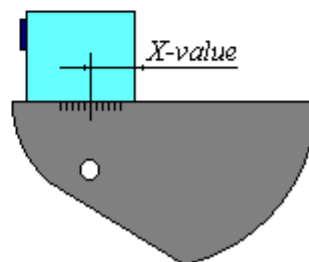
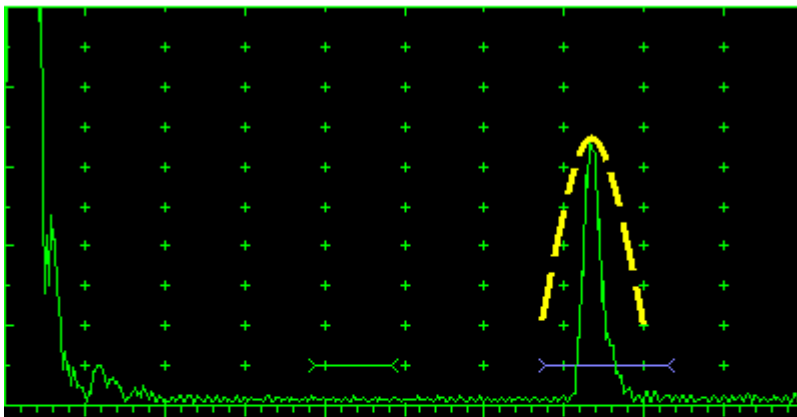
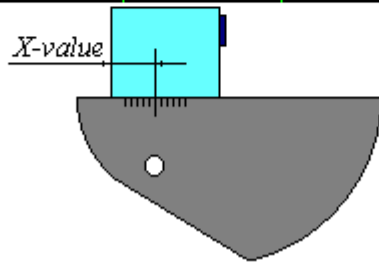
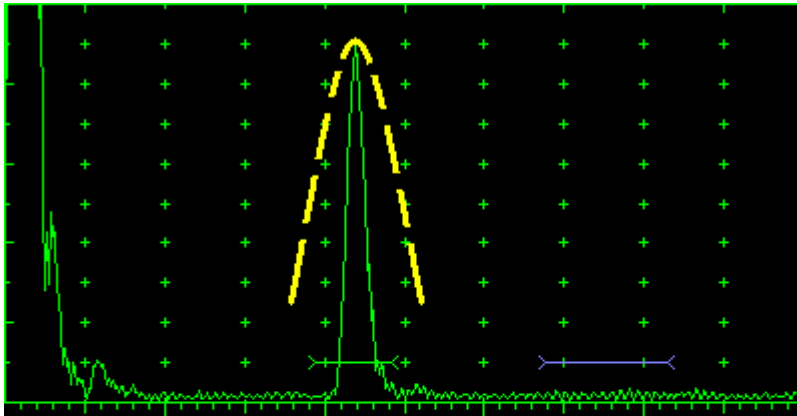



There are 2 maximized reference echoes from 2 concave reflectors with different radius 25 mm (1 in) and 50 mm (2 in) in use for performing automatic calibration of **Probe Delay** and **US Velocity**. **A-Scan** settings (**Range**, **Display Delay**, **US Velocity** – refer to paragraph 5.2.2 of this Operating Manual) must allow observing of both signals. **Gate A** to match with first reference echo received from concave reflector with smaller radius (shorter material travel distance) – refer to paragraph 5.2.5 of this Operating Manual. **Gate B** to match with second reference echo received from concave reflector with larger radius (longer material travel distance) – refer to paragraph 5.2.6 of this Operating Manual



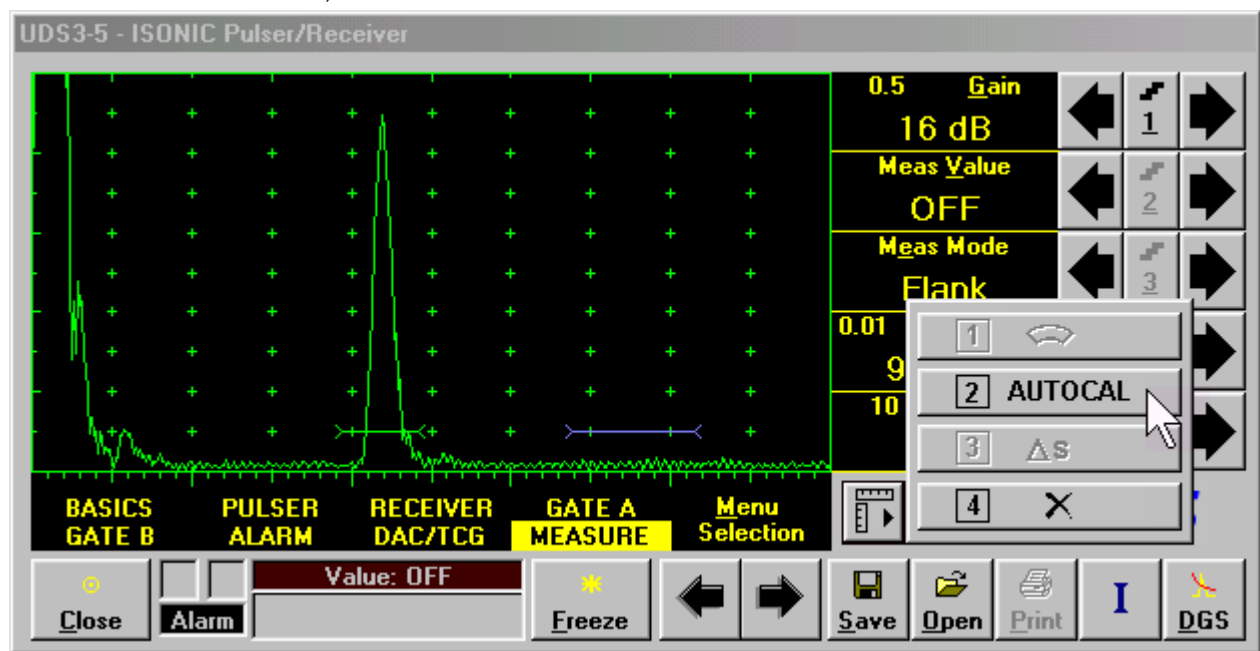

- ◆ It's necessary to setup **Gain** bringing height of back echo to **75-80%** of **A-Scan** height
- ◆ It is recommended to optimize **Tuning** in **PULSER** submenu upon obtaining back echo. The goal of such optimization is increasing of ultrasonic excitation energy through better matching between firing output and probe. Level of ultrasonic excitation energy is clearly represented by back echo amplitude. Upon completing **Tuning** optimization **Gain** to be adjusted to bring echo to **75-80%** of **A-Scan** height

Obtain first reference echo, activate submenu MEASURE then click on 

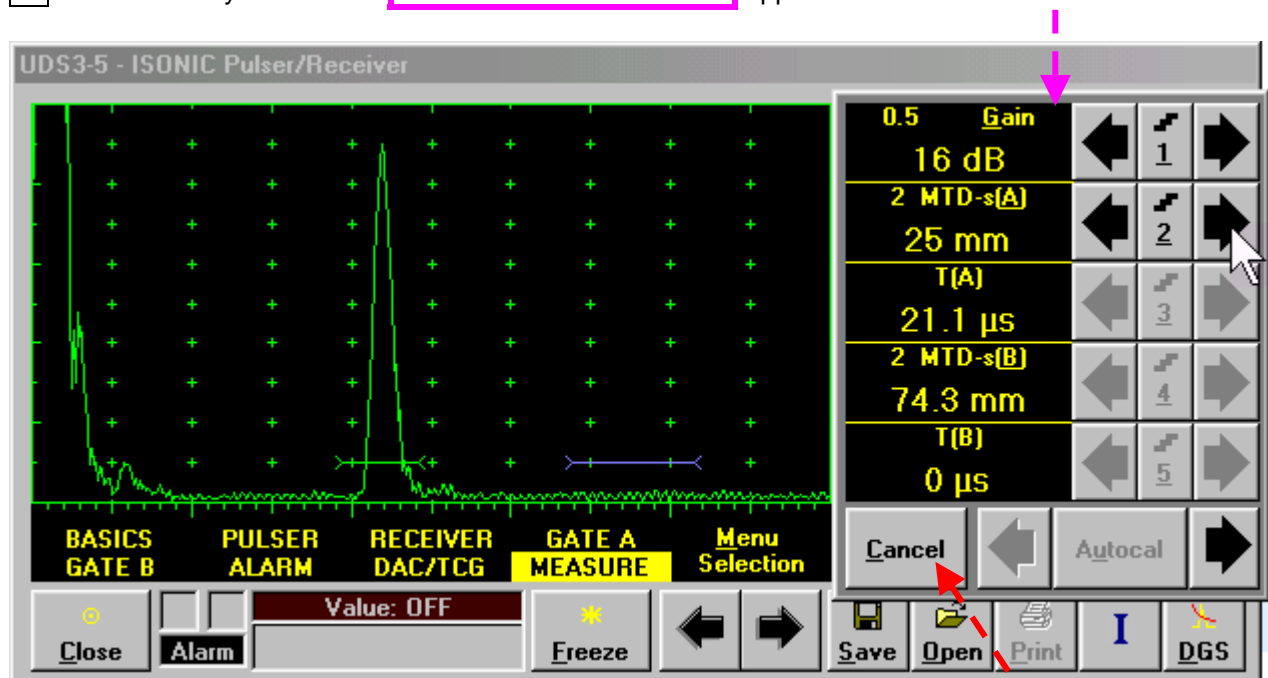

To activate AUTOCAL procedure click on **2 AUTOCAL** or press  on front panel keyboard or **F2** on external keyboard – the **AUTOCAL Control Surface** appears



Click on this button or press  on front panel keyboard or **Esc** or **<Alt>+<C>** on external keyboard to interrupt **AUTOCAL** Procedure and return to main UDS 3-5 control surface

If necessary **Gain** may be re-adjusted in the **AUTOCAL Control Surface** by the same way as it is explained in paragraph 5.2.2 of this Operating Manual



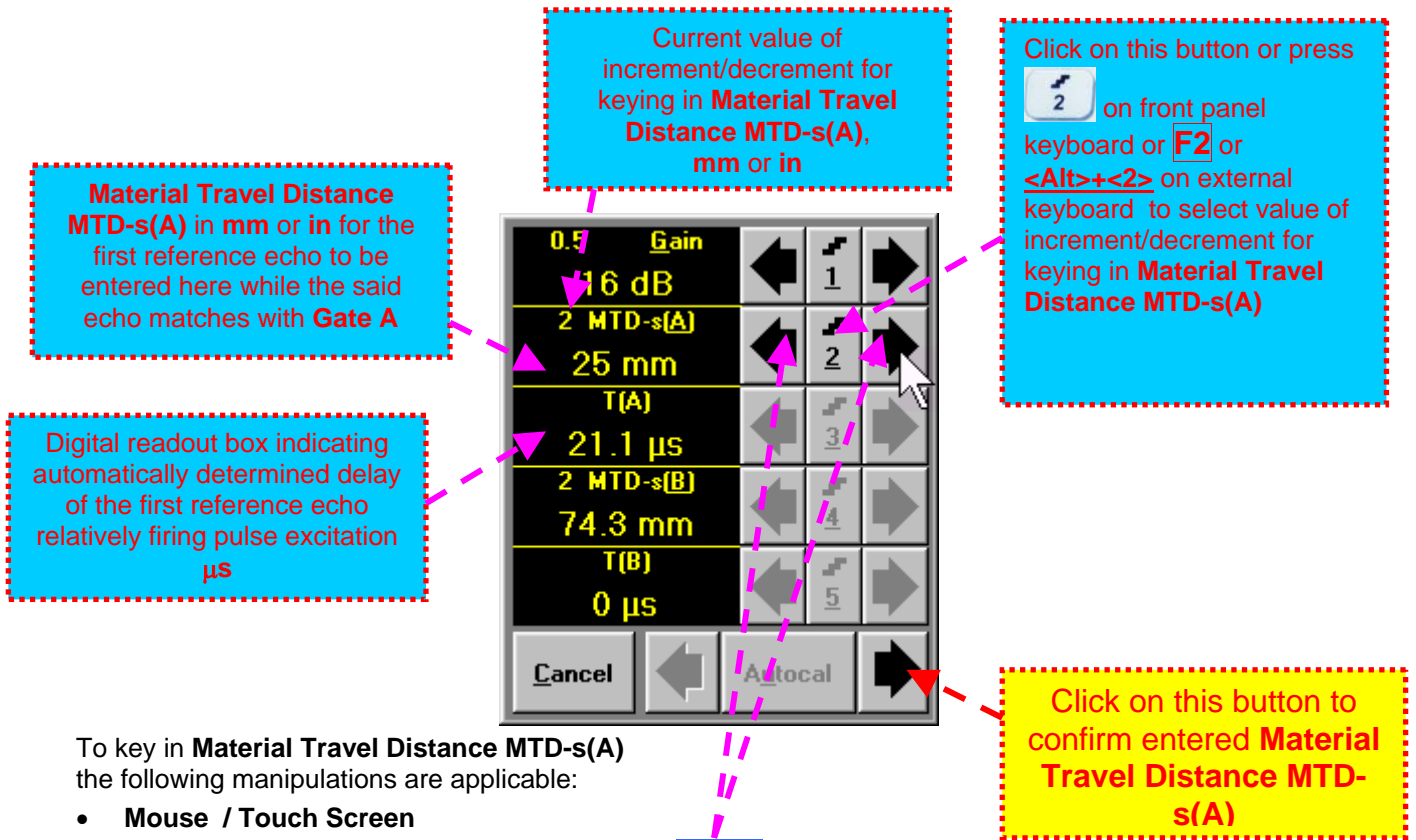

To key in **Material Travel Distance MTD-s(A)** the following manipulations are applicable:

- **Mouse / Touch Screen**
  - Click or press and hold on the appropriate button
- **Keyboard**
  - Press on front panel keyboard or **F2** or **<Alt>+<A>** on external keyboard  $\Rightarrow$  **MTD-s(A)** fore color changes to white - then use , , , on front panel keyboard or , , , on external keyboard
- **Combined**
  - Click on **MTD-s(A)**  $\Rightarrow$  **MTD-s(A)** fore color changes to white - then use , , , on front panel keyboard or , , , on external keyboard

Upon confirming keying in **Material Travel Distance MTD-s(A)** obtain second reference echo

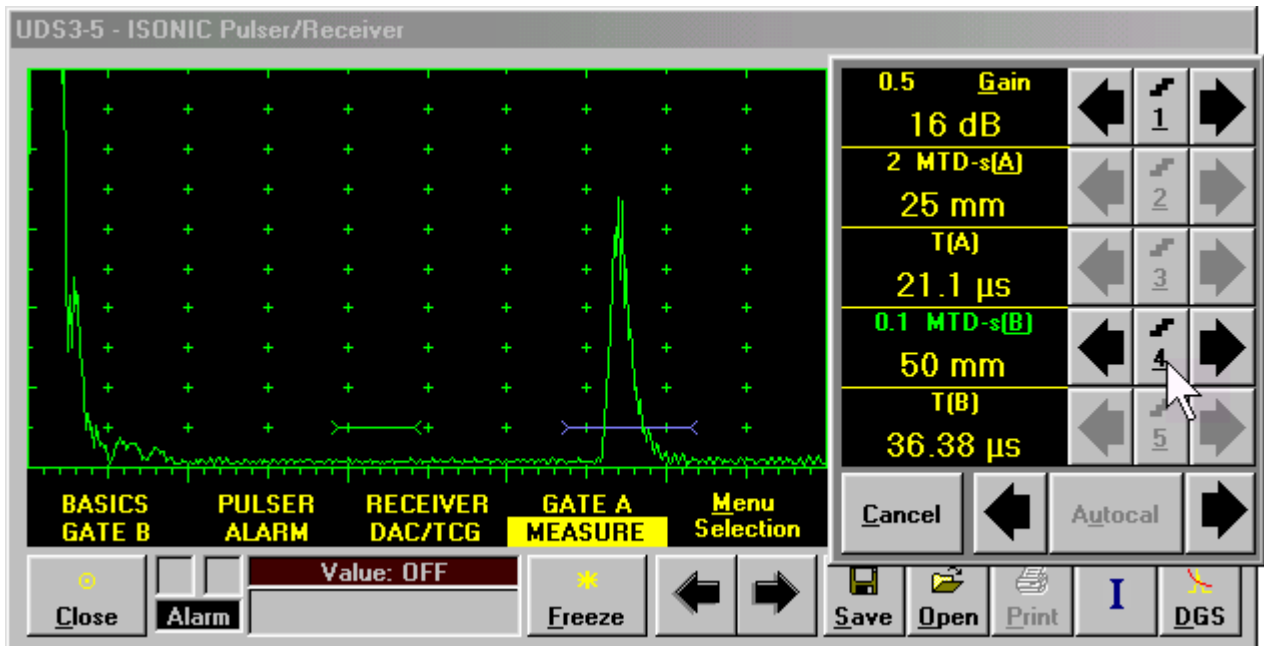

Material Travel Distance MTD-s(B) in mm or in for the second reference echo to be entered here while the said echo matches with Gate B

Current value of increment/decrement for keying in Material Travel Distance MTD-s(B), mm or in

Click on this button or press  on front panel keyboard or **F4** or **<Alt>+<4>** on external keyboard to select value of increment/decrement for keying in Material Travel Distance MTD-s(B)



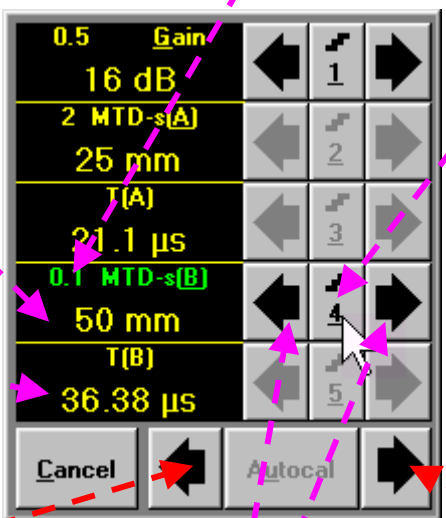





Digital readout box indicating automatically determined delay of the second reference echo relatively firing pulse excitation  $\mu\text{s}$



Click on this button if it is necessary to return back to keying in Material Travel Distance MTD-s(A)



Click on this button to confirm entered Material Travel Distance MTD-s(B)

To key in Material Travel Distance MTD-s(B) the following manipulations are applicable:

- **Mouse / Touch Screen**
  - Click or press and hold on the appropriate button
- **Keyboard**
  - Press  on front panel keyboard or **F4** or **<Alt>+<B>** on external keyboard  $\Rightarrow$  **MTD-s(B)** fore color changes to white - then use , , ,  on front panel keyboard or  $\uparrow$ ,  $\rightarrow$ ,  $\leftarrow$ ,  $\downarrow$  on external keyboard
- **Combined**
  - Click on **MTD-s(B)**  $\Rightarrow$  **MTD-s(B)** fore color changes to white - then use , , ,  on front panel keyboard or  $\uparrow$ ,  $\rightarrow$ ,  $\leftarrow$ ,  $\downarrow$  on external keyboard

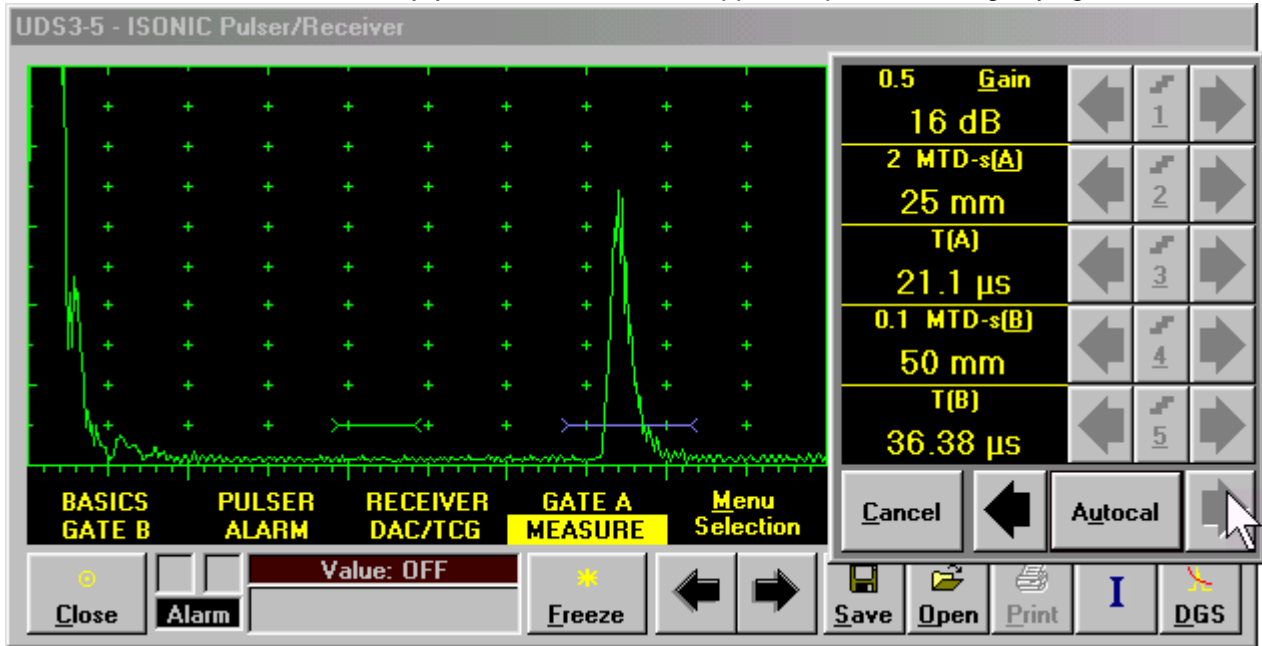
**Material Travel Distance MTD-s(B)** The screen as below appears upon confirming keying in



- ◆ Click on  if it is necessary to return back to keying in **Material Travel Distance MTD-s(A)**
- ◆ Click on  or press  on front panel keyboard or Enter or <Alt>+<U> on external keyboard to initialize automatic determining of **US Velocity** and **Probe Delay** based on above described keying and echoes delays automatic measurements. As a result the screen as below appears:

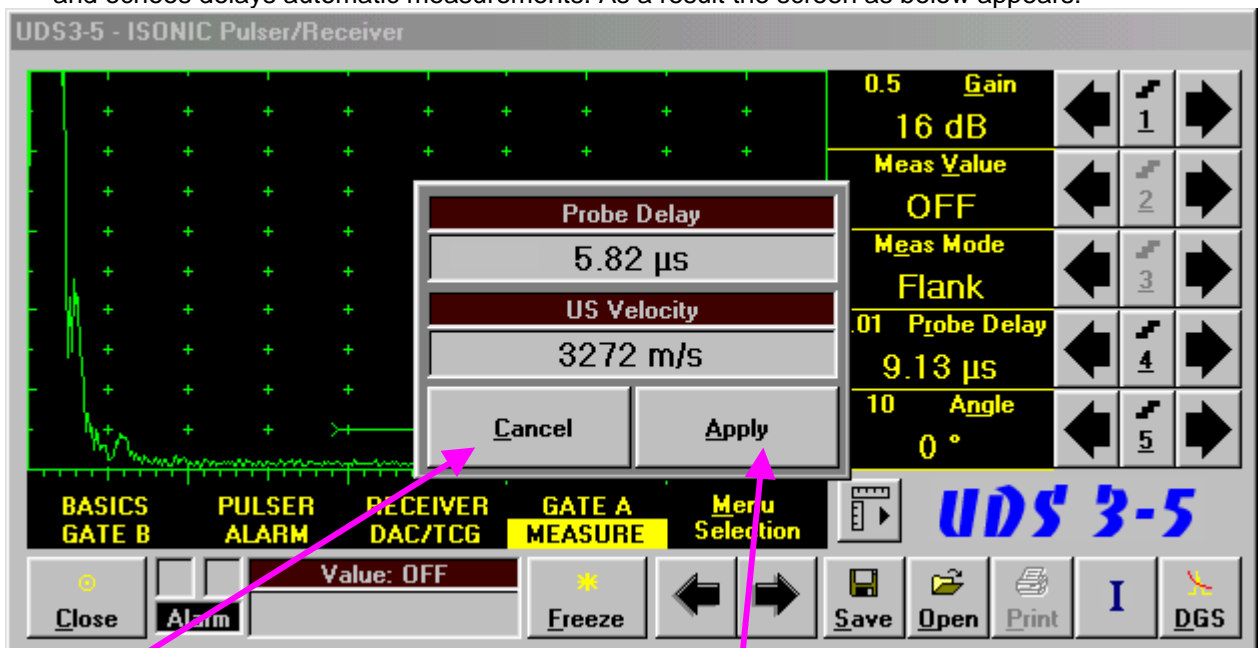

Click on  or press **Esc** or <Alt>+<C> on external keyboard to negate **AUTOCAL** results and return to main operating surface without modifying **Probe Delay** and **US Velocity** settings

Click on  or press **Enter** or <Alt>+<A> on external keyboard to accept **AUTOCAL** results and return to main operating surface with appropriate modifying **Probe Delay** and **US Velocity** settings

### 5.2.13.9. Automatic Calibration of Probe Delay and US Velocity - Straight Beam (Normal) Single Element and Dual (TR) Probes – Typical Example

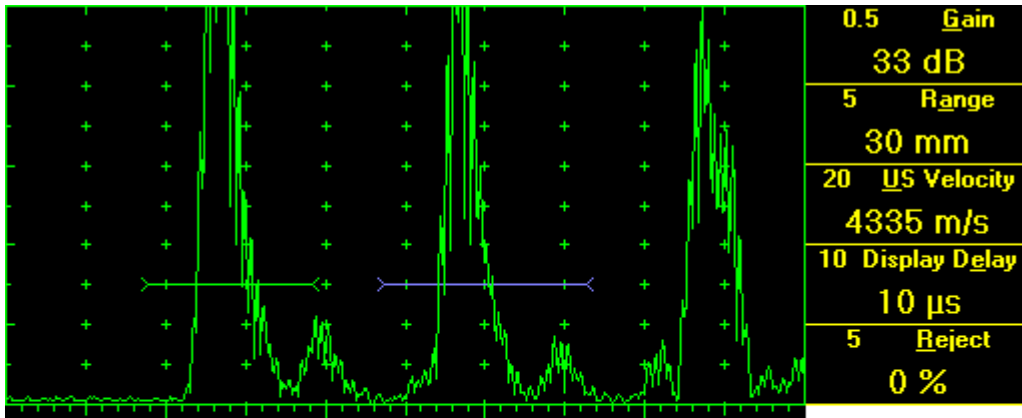

There are 2 sequentially received back echoes required for performing automatic calibration of **Probe Delay** and **US Velocity**. **A-Scan** settings (**Range**, **Display Delay**, **US Velocity** – refer to paragraph 5.2.2 of this Operating Manual) must allow observing of both signals.

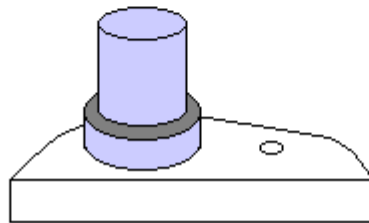

**Gate A** to match with first back echo (shorter material travel distance) – refer to paragraph 5.2.5 of this Operating Manual. **Gate B** to match with second back echo (longer material travel distance) – refer to paragraph 5.2.6 of this Operating Manual



- ◆ It's necessary to setup **Gain** bringing height of back echo to **75-80%** of **A-Scan** height
- ◆ It is recommended to optimize **Tuning** in **PULSER** submenu upon obtaining back echo. The goal of such optimization is increasing of ultrasonic excitation energy through better matching between firing output and probe. Level of ultrasonic excitation energy is clearly represented by back echo amplitude. Upon completing **Tuning** optimization **Gain** to be adjusted to bring echo to **75-80%** of **A-Scan** height

All further operations to be performed identically to described in paragraph 5.2.13.8 of this Operating Manual

### 5.2.13.10. Determining Incidence Angle (Probe Angle)

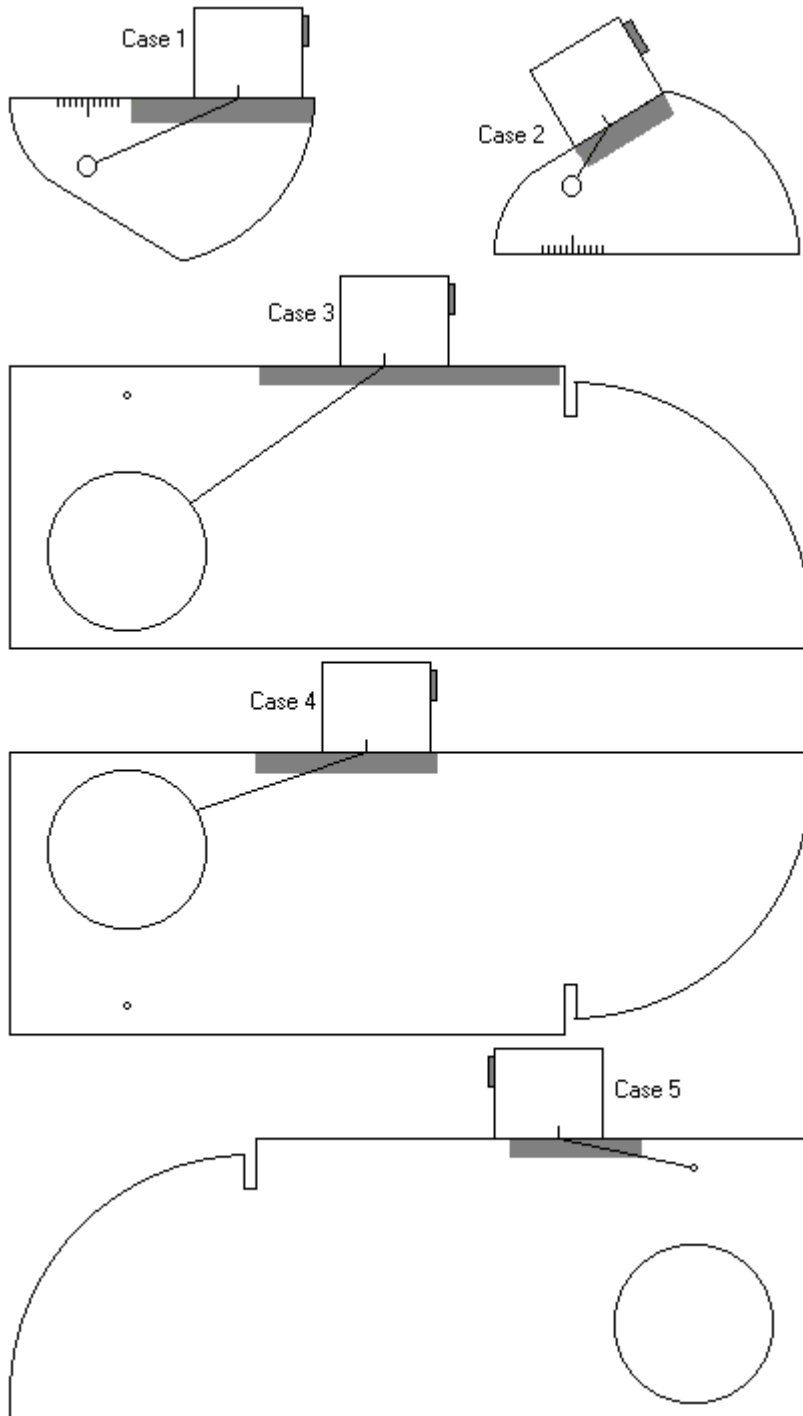

Determining of incidence angle is based on maximizing echo from side-drilled hole in reference block and reading the value of angle from corresponding scale. Depending on probe dimensions and angles there are various reference blocks and scales applicable:

**Case 1:** Miniature angle beam probe, incidence angle  $35^{\circ}$  to  $65^{\circ}$ , V-2 reference block

**Case 2:** Miniature angle beam probe, incidence angle  $65^{\circ}$  to  $75^{\circ}$ , V-2 reference block

**Case 3:** Medium or large size angle beam probe, incidence angle  $40^{\circ}$  to  $66^{\circ}$ , V-1 reference block

**Case 4:** Medium or large size angle beam probe, incidence angle  $60^{\circ}$  to  $76^{\circ}$ , V-1 reference block

**Case 5:** Medium or large size angle beam probe, incidence angle  $74^{\circ}$  to  $80^{\circ}$ , V-1 reference block

## 5.2.14. Frequency Domain Signal Presentation and Evaluation

Using **Range** and **Delay** parameters select a portion of **A-Scan** for frequency domain (FFT) presentation then do activate submenu **RECEIVER** and switch **Display** to **FFT** (refer to paragraph 5.2.4 of this Operating Manual). The screen as below appears:

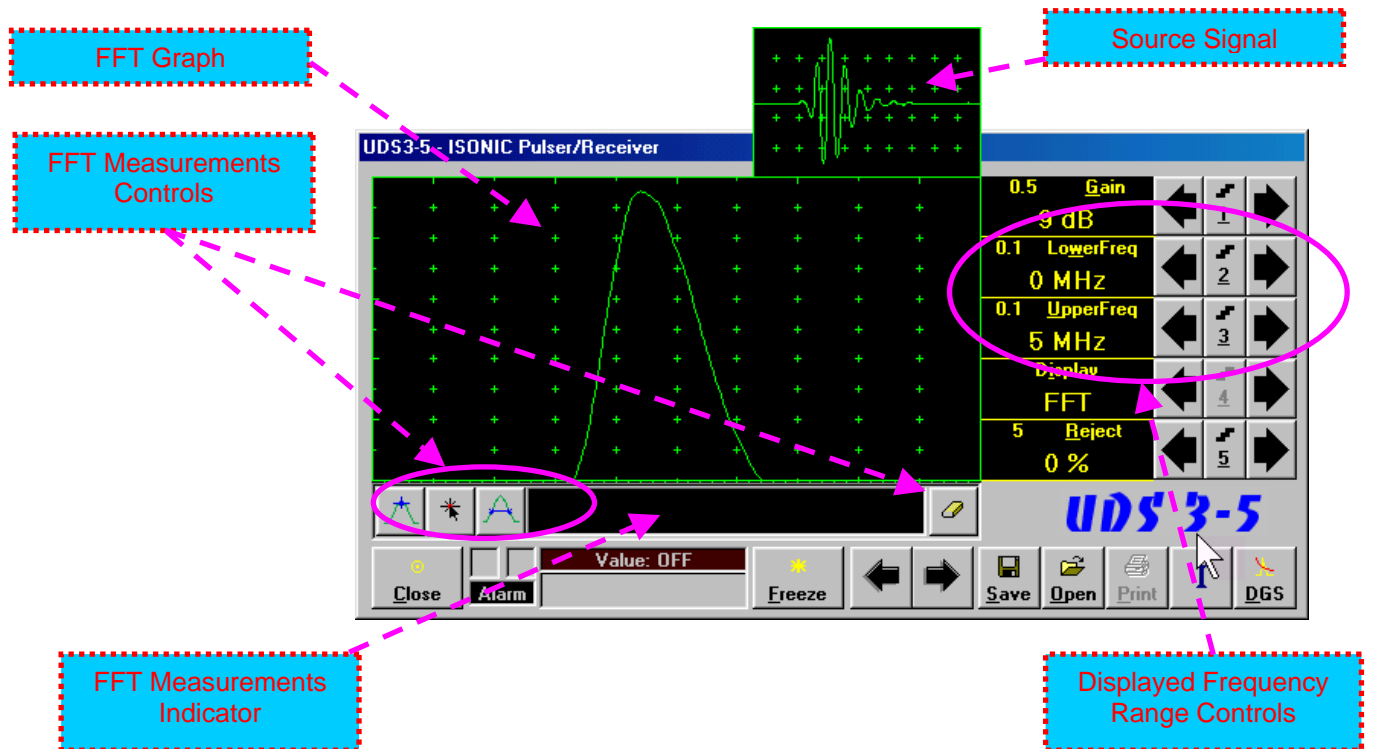

**i** Display may not be switched into the **FFT** if the **Range** value is too long or **DAC/TCG/DGS** is active

**Lower frequency bound (LowerFreq)**

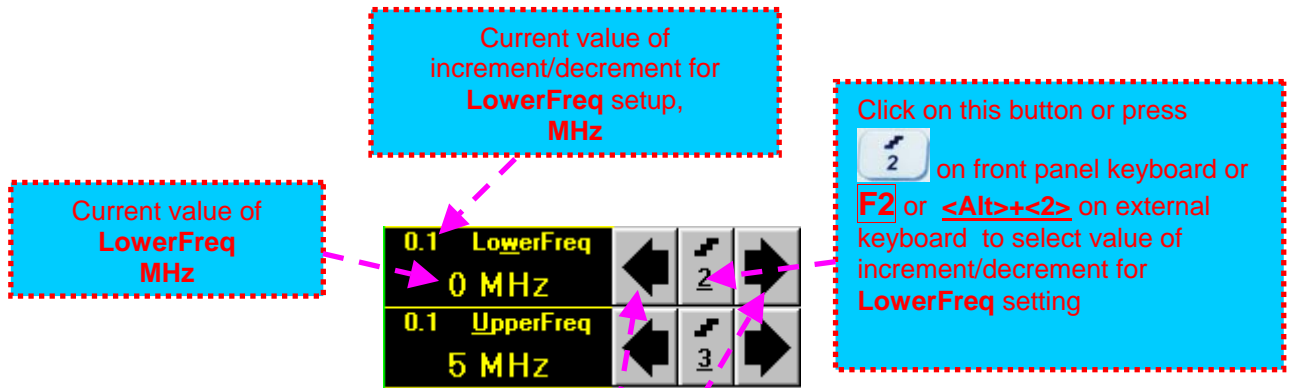









To control **LowerFreq** the following manipulations are applicable:









- **Mouse / Touch Screen**

- Click or press and hold on appropriate button

- **Keyboard**

- Press  on front panel keyboard or **F2** or **<Alt>+<W>** on external keyboard ⇒ **LowerFreq** fore color changes to white - then use , , ,  on front panel keyboard or , , ,  on external keyboard

- **Combined**

- Click on **LowerFreq** ⇒ **LowerFreq** fore color changes to white - then use , , ,  on front panel keyboard or , , ,  on external keyboard

## Upper frequency bound (UpperFreq)

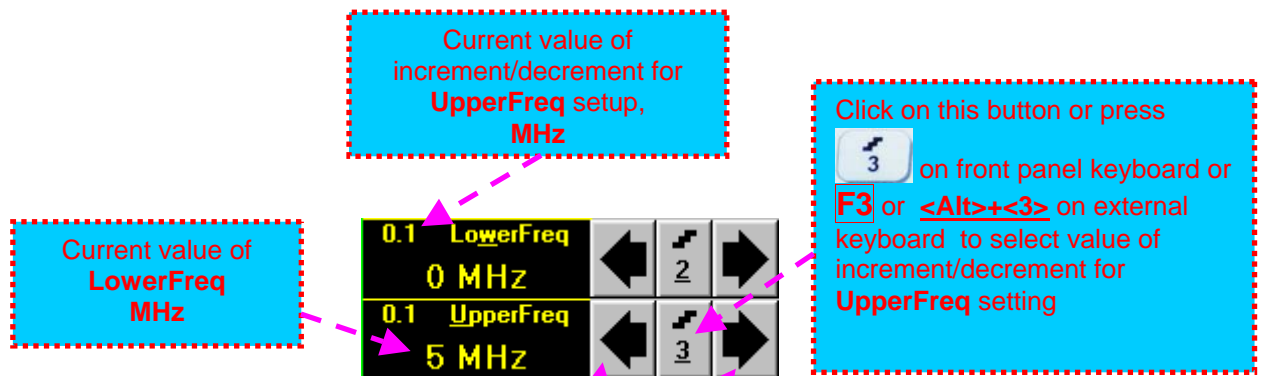

To control **UpperFreq** the following manipulations are applicable:

- **Mouse / Touch Screen**

- Click or press and hold on the appropriate button

- **Keyboard**



- Press 3 on front panel keyboard or **F3** or **<Alt>+<U>** on external keyboard ⇒ **UpperFreq** fore color changes to white - then use ↑, →, ←, ↓ on front panel keyboard or ↑, →, ←, ↓ on external keyboard

- **Combined**

- Click on **UpperFreq** ⇒ **UpperFreq** fore color changes to white - then use ↑, →, ←, ↓ on front panel keyboard or ↑, →, ←, ↓ on external keyboard



## Find maximum

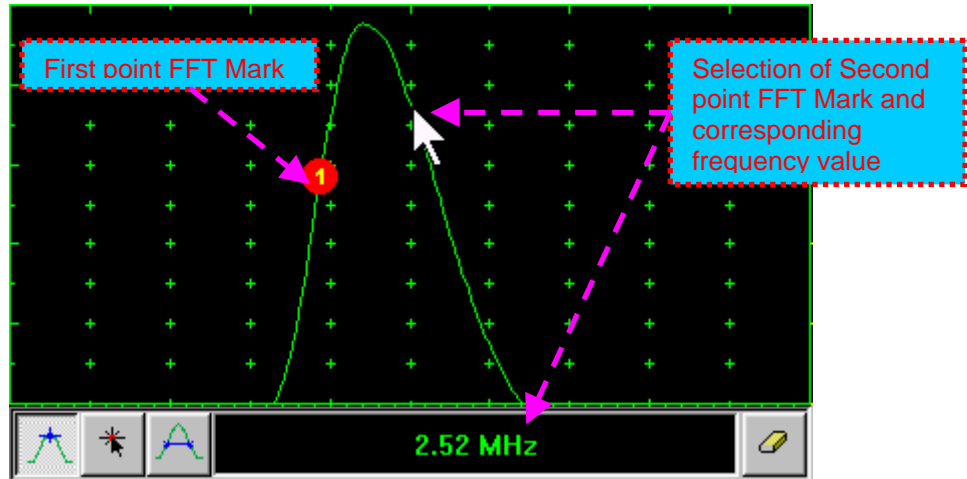

Click on  – mouse pointer may be guided then just over FFT graph. **FFT Readout Box** displays frequency corresponding to pointer position whilst guiding the cursor. Select first point of interest by mouse click or through release of touch screen stylus. The appropriate mark  appears. Select the second point of interest by the same way

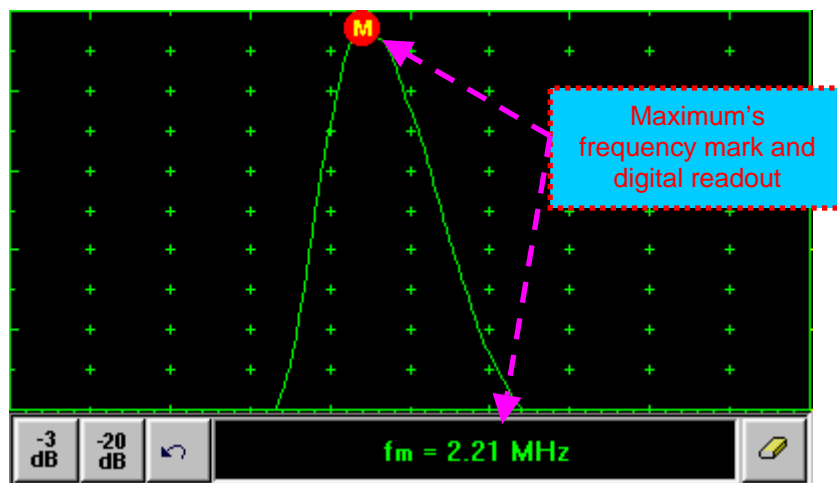

**Maximum's frequency mark**  appears and **FFT Readout Box** displays the found value automatically upon mouse click or releasing of touch screen stylus:



**Find the -3db / -20db level bounds:**

Upon finding the maximum's frequency click on  or . Two points found corresponding to selected level appear on the FFT graph and **FFT Readout Box** shows their corresponding frequency values:

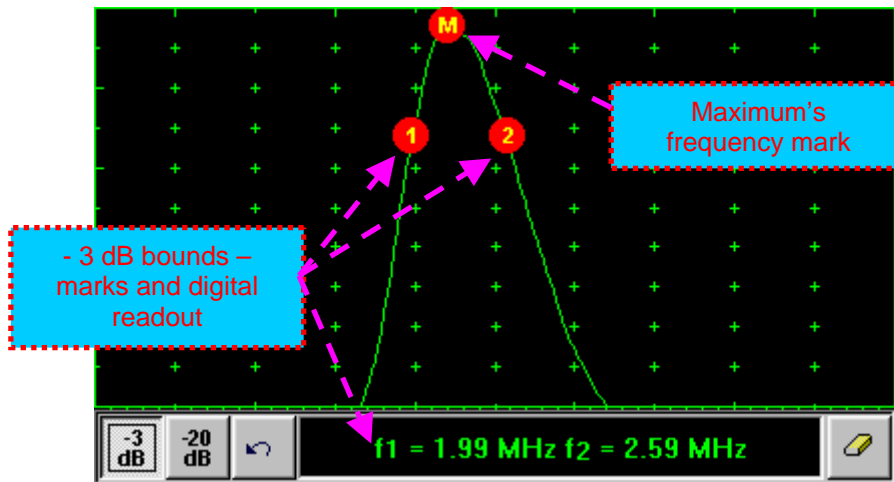

**Return to FFT Measurements toolbar:**

Click on 

**Find frequency corresponding to selected single point on FFT graph:**

Click on  – mouse pointer may be guided then just over FFT graph. **FFT Readout Box** displays frequency corresponding to pointer position whilst guiding the cursor. Select first point of interest by mouse click or through release of touch screen stylus. The appropriate mark **1** appears and **FFT Readout Box** displays corresponding frequency:

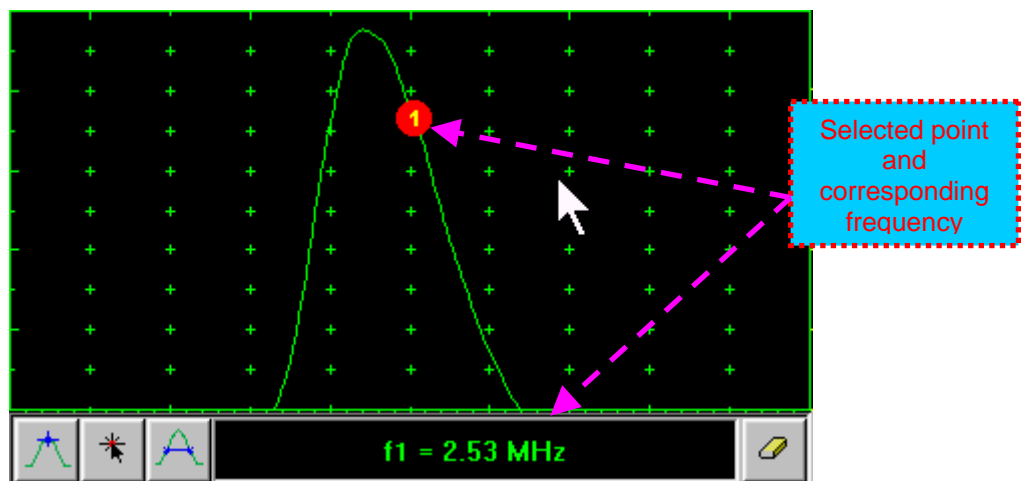

### Frequency difference (deviation) between two points:

Click on  – mouse pointer may be guided then just over FFT graph. **FFT Readout Box** displays frequency corresponding to pointer position whilst guiding the cursor. Select first point of interest by mouse click or through release of touch screen stylus. The appropriate mark **1** appears. Select second point of interest by the same way - the appropriate mark **2** appears and the **FFT Readout Box** displays difference (deviation) between corresponding frequencies:

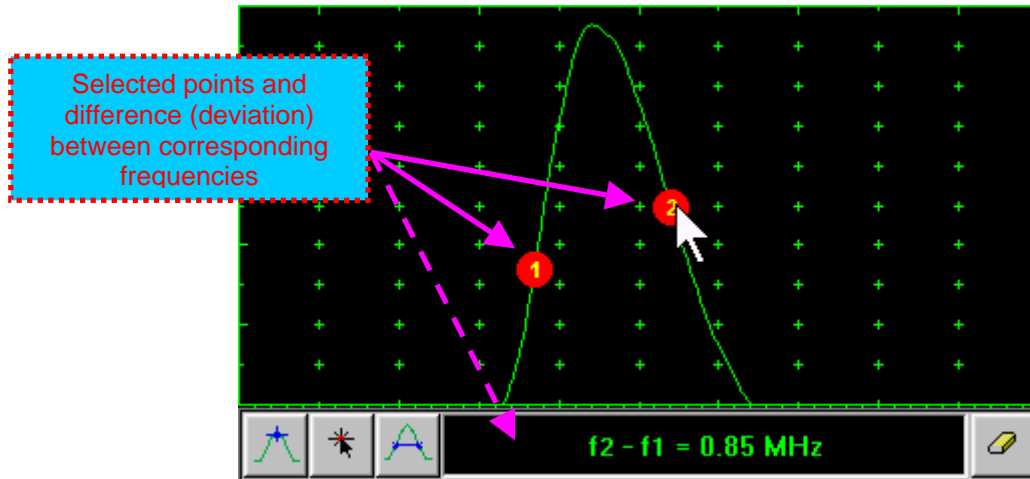

### Clear FFT Marks:



Click on 

### Exit FFT Mode:

Change **Display** mode

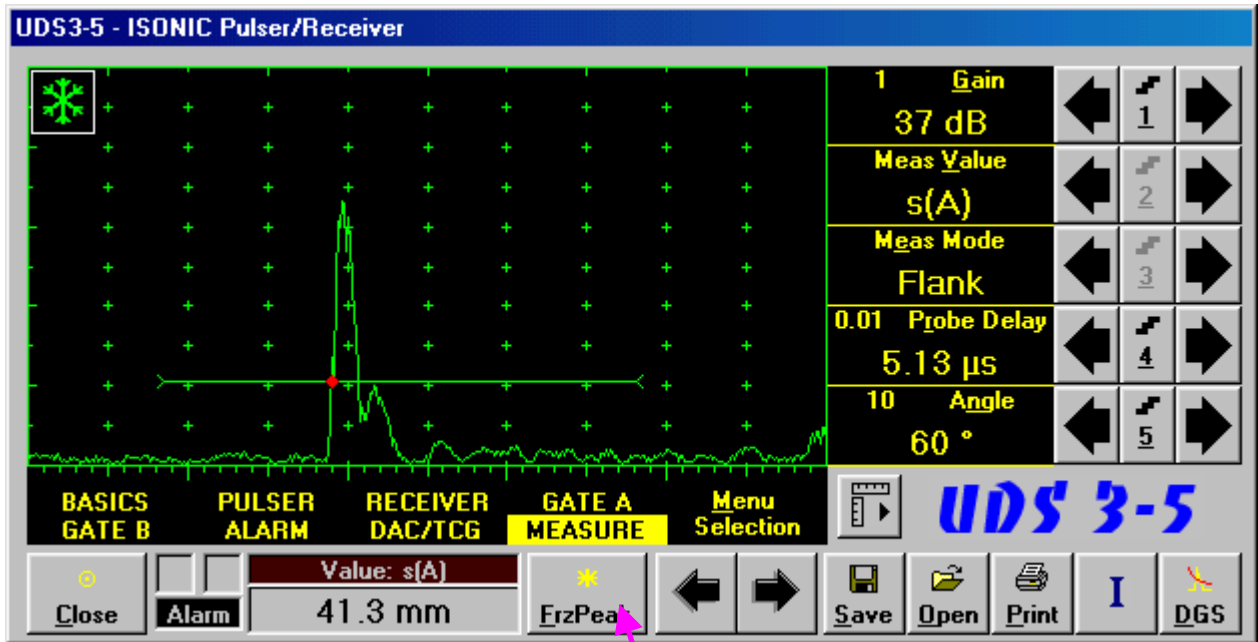
## 5.2.15. Freeze A-Scan / FFT Graph





To freeze / freeze peak / unfreeze the **A-Scan** click  or press  on front panel keyboard or **F6** or **<Alt>+<F>** on external keyboard

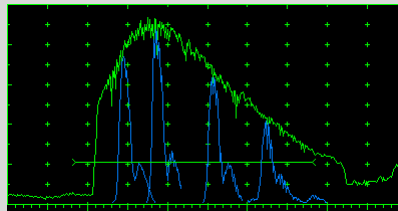

- ◆ **Freeze Peak** mode allows representing of Hilbert envelop for sequence of echoes obtained while manipulating probe over some reflector. This function may be useful for localization of echo maximum when working in A-Scan mode:





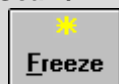

- ◆ **Freeze Peak** mode may not be activated for RF and FFT signal presentation
- ◆ Appearing of  at the upper left corner of **A-Scan** indicates that it is frozen (**Freeze**)
- ◆ Appearing of  at the upper left corner of **A-Scan** indicates that **Freeze Peak** mode is active
- ◆ The following operations are available when time domain **A-Scan** is frozen:
  - $\pm 6$  dB **Gain** varying according to paragraph 5.2.2 of this Operating Manual
  - Manipulating **Gates A** and **B** according to paragraphs 5.2.5, 5.2.6, 5.2.7 of this Operating Manual
  - Varying **Alarm** mode according to paragraph 5.2.8 of this Operating Manual
  - Selecting parameter (**Meas Value**) for automatic measurements and varying settings **Probe Delay** and **Angle** as per paragraph 5.2.12 of this Operating Manual and obtaining corresponding measurements results in the digital readout box (**Value**)
- ◆ The following operations are available while frequency domain **FFT Graph** is frozen:
  - $\pm 6$  dB **Gain** varying according to paragraph 5.2.2 of this Operating Manual
  - All **FFT evaluation / measurements** as per paragraph 5.2.14 of this Operating Manual
- ◆ Caption of appropriate button changes in the **UDS 3-5 Pulser/Receiver** window when freeze / freeze peak / unfreeze **A-Scan / FFT Graph**



## 5.2.16. Zoom A-Scan / FFT Graph

Double click on **A-Scan / FFT Graph** to get it enlarged. Enlarged **A-Scan / FFT Graph** occupies screen completely





In upright corner of **A-Scan** there is a digital readout box indicating current **Gain** value and digital readout of automatic measurements provided that corresponding **Gate** is active

To control **Gain** while **A-Scan** is enlarged use  and  on front panel keyboard or ,  on external keyboard

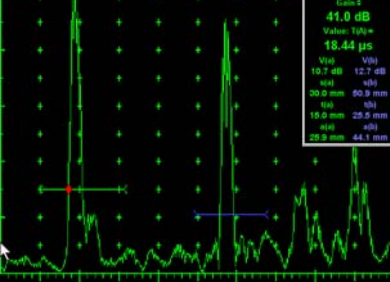
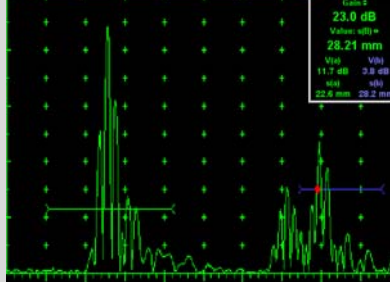
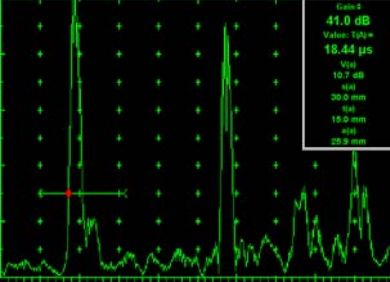
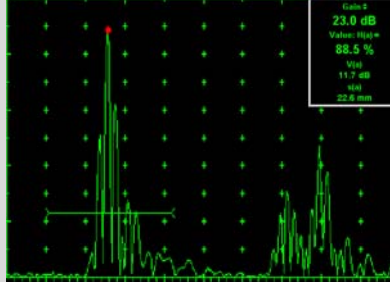
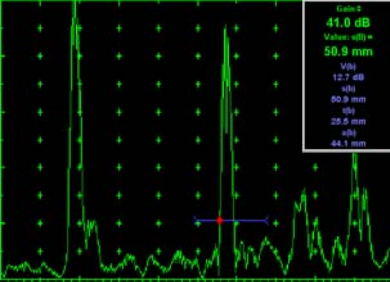
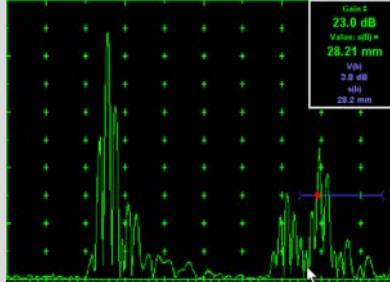
To freeze / freeze peak / unfreeze enlarged **A-Scan** press  on front panel keyboard or **F6** on external keyboard

If **Gate A** and / or **Gate B** is active then:

| Active Gate | Angle Beam Probe<br>Angle > 0° in the submenu MEASURE  | Straight Beam Probe<br>Angle = 0° in the submenu MEASURE  |
|-------------|--|---|
| A and B     |  <p>Parameters <b>V(A)</b>, <b>s(A)</b>, <b>t(A)</b>, <b>a(A)</b>, <b>V(B)</b>, <b>s(B)</b>, <b>t(B)</b>, and <b>a(B)</b> are measured and indicated automatically – refer to paragraph 5.2.13.1 of this Operating Manual</p> |  <p>Parameters <b>V(A)</b>, <b>s(A)</b>, <b>V(B)</b>, and <b>s(B)</b> are measured and indicated automatically – refer to paragraph 5.2.13.1 of this Operating Manual</p> |
| A           |  <p>Parameters <b>V(A)</b>, <b>s(A)</b>, <b>t(A)</b>, and <b>a(A)</b> are measured and indicated automatically – refer to paragraph 5.2.13.1 of this Operating Manual</p>   |  <p>Parameters <b>V(A)</b>, and <b>s(A)</b> are measured and indicated automatically – refer to paragraph 5.2.13.1 of this Operating Manual</p>                         |
| B           |  <p>Parameters <b>V(B)</b>, <b>s(B)</b>, <b>t(B)</b>, and <b>a(B)</b> are measured and indicated automatically – refer to paragraph 5.2.13.1 of this Operating Manual</p>   |  <p>Parameters <b>V(B)</b>, and <b>s(B)</b> are measured and indicated automatically – refer to paragraph 5.2.13.1 of this Operating Manual</p>                         |

To select an additional parameter for automatic measurement and large character indication while **A-Scan** is enlarged (**Meas Value** - refer to paragraphs 5.2.12 and 5.2.13 of this Operating Manual) use  and  on front panel keyboard or ,  on external keyboard. **Gate A** and **Gate B** if active may be drag and drop manipulated on the enlarged **A-Scan** according to paragraph 5.2.7 of this Operating Manual. To return to main operating surface window double click on enlarged **A-Scan / FFT Graph**

## 5.2.17. Save an A-Scan and its Calibration Dump into a file

To save the **A-Scan / FFT Graph** and **Calibration Dump** into a file click on  or press  on front panel keyboard or **F12** or **<Alt>+<S>** on external keyboard – **ISONIC 2005 Save/Open** window becomes active providing automatically created name for a new file in **File name:** box:

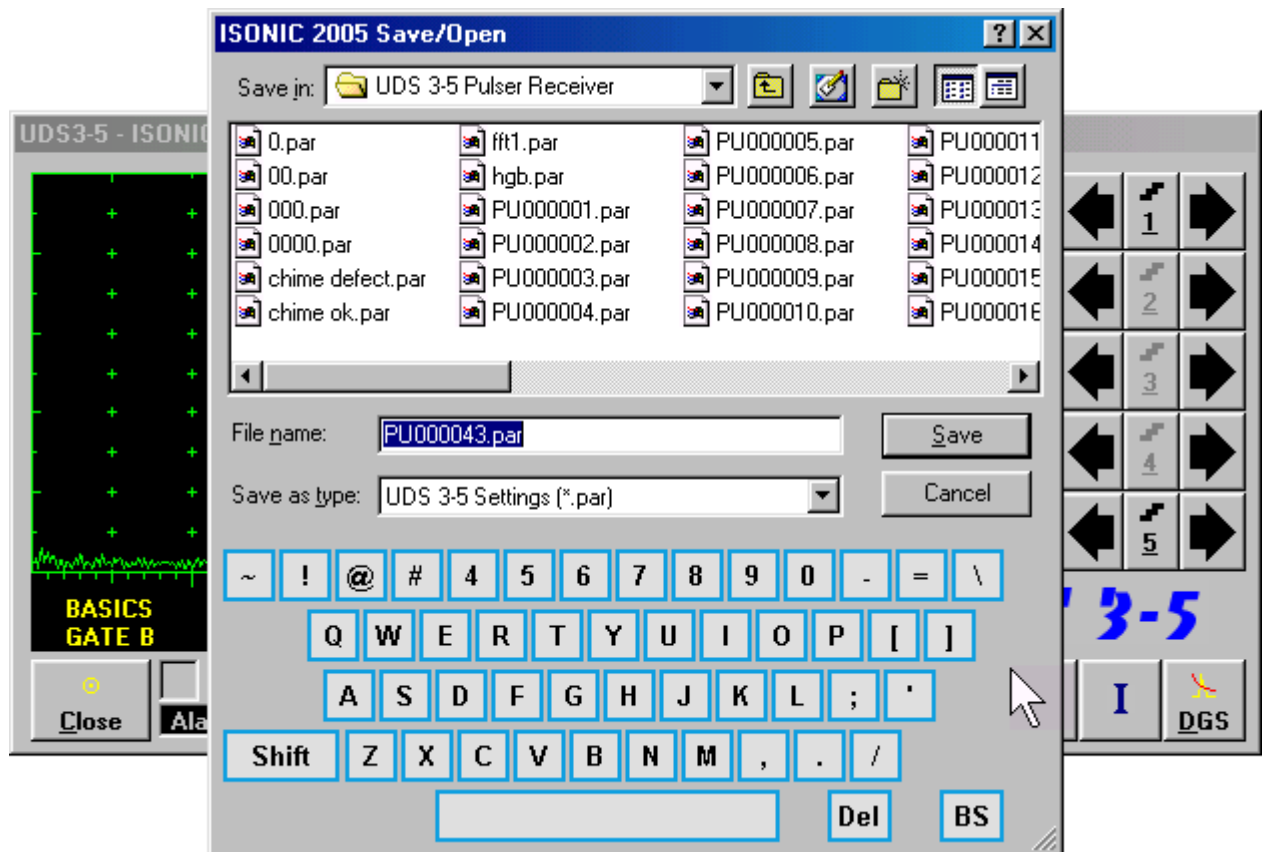

To save a file:



- select disk drive and directory for placing a file using mouse or touch screen
- approve automatically created new file name

OR



mark a file to be replaced from the list appearing in the destination directory

OR

type a new file name using either virtual keyboard generated in **ISONIC 2005 Save/Open** window or external keyboard – standard Windows rules for file naming are applicable, long names (up to 64 characters) are supported

- double click on file to be replaced or click on  or press  or  on front panel keyboard or press **F12** or **Enter** or **<Alt>+<S>** on external keyboard

**ISONIC 2005 Save/Open** window disappears automatically upon completing saving a file



To exit from **ISONIC 2005 Save/Open** window without saving a file click on  or press  on front panel keyboard or **Esc** on external keyboard

## 5.2.18. Load an A-Scan and its Calibration Dump from a file

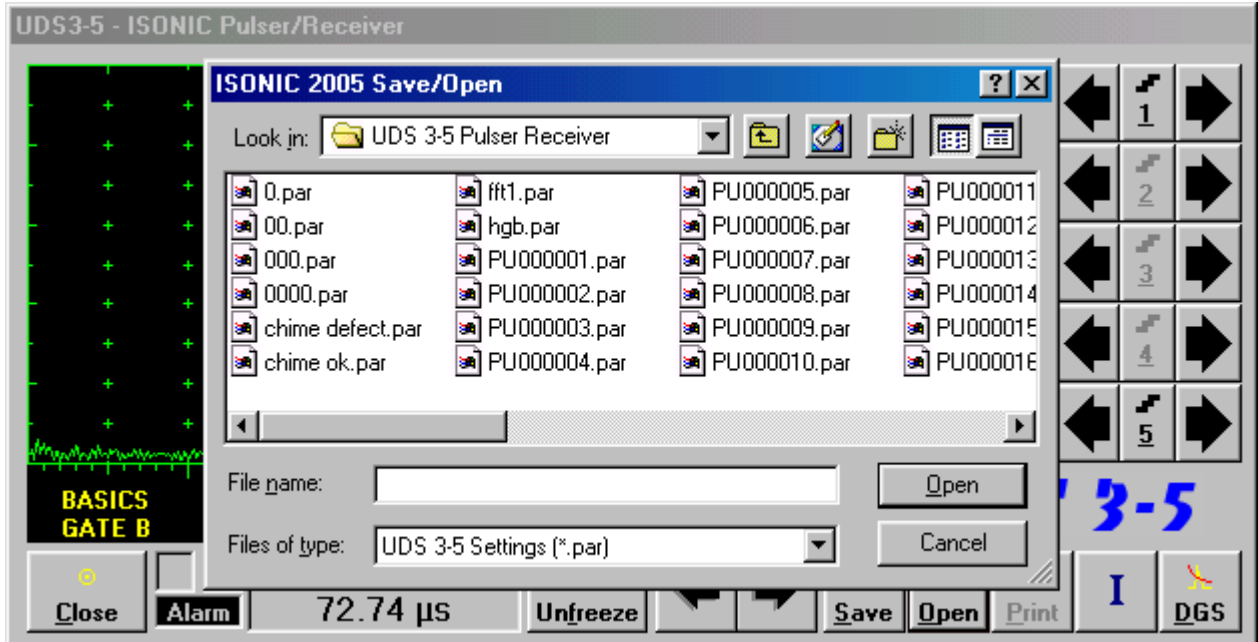

To load **A-Scan/FFT Graph** and **Calibration Dump** from a file click on  or press  on front panel keyboard or **F11** or **<Alt>+<O>** on external keyboard – **<Alt>+<O>** on the keyboard – **ISONIC 2005 Save/Open** window becomes active



To open a file:

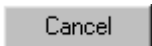

- select disk drive and directory containing a file required
- select then file then double click on its name or click on  or press  or  on front panel keyboard or **F11** or **Enter** or **<Alt>+<O>** on external keyboard

**ISONIC 2005 Save/Open** window disappears automatically upon completing loading a file



To exit from **ISONIC Save/Open** window without opening a file click on  or press  on front panel keyboard or **Esc** on external keyboard

### 5.2.19. Print A-Scan/FFT Graph and Settings List

Ensure the printer connection is in order (printer to be accessible through either USB or LAN port and

defined as default in the **ISONIC 2005**) then click on  or press  on front panel keyboard or **F10** or **<Alt>+<P>** on external keyboard

### 5.2.20. Activate Main Recording Menu for Single Channel Operation using CH 1

Click on  or press  on front panel keyboard or **F8** on external keyboard. Refer to Chapter 6 of this Operating Manual for further instructions

### 5.2.21. Switch OFF UDS 3-5

To switch OFF UDS 3-5 click on  or press  on front panel keyboard or **ESC** or **<Alt>+<C>** on external keyboard



## **6. Recording and Imaging – Single Channel (CH 1)**

## 6.1. Main Recording Menu – Single Channel (CH 1)

Main Recording Menu – Single Channel (CH 1) is shown below:





There are 2 recording submenus available:

- ◆ **Time Based Recording** submenu relates to line scanning procedures where probe is manipulated over object under test with constant speed and defects images are formed from sequence of **A-Scans** captured at equal time intervals (real time clock). To open **Time Based**

**Recording** submenu click on  or press  on front panel keyboard or **F1** on external keyboard

- ◆ **True to Location Recording** submenu relates to line scanning procedures where coordinate of probe manipulated over object under test is transferred to **ISONIC 2007** instrument by means of position encoder while defects images are formed from sequence of **A-Scans** captured at equal









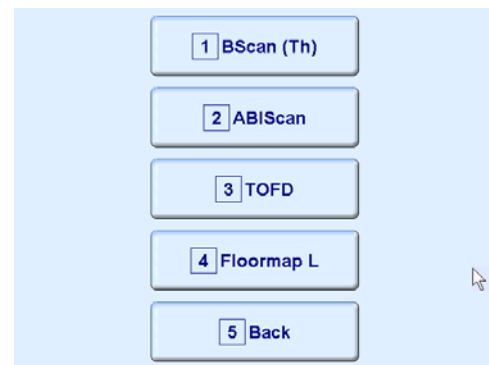



distance intervals. To open **True to Location Recording** submenu click on  or press  on front panel keyboard or **F2** on external keyboard



To return to main operating surface click on  or press  or  on front panel keyboard or **Esc** or **F3** on external keyboard

## 6.2. Time Based and True to Location Recording Submenus

Both **Time Based Recording** and **True to Location Recording** submenus allow activating 4 protocols of data recording:





- ◆ **Thickness Profile imaging and recording – t-BScan(Th) or BScan(Th)** – click on  or  or press  on front panel keyboard or **F1** on external keyboard – illustrative video is available at <http://www.sonotronndt.com/video.asp?VideID=1>
- ◆ **B-Scan cross-sectional imaging and recording of defects for longitudinal and shear wave inspection – t-ABIScan or ABIScan** – click on  or  or press  on front panel keyboard or **F2** on external keyboard – illustrative video is available at <http://www.sonotronndt.com/video.asp?VideID=2>
- ◆ **TOFD Inspection – RF B-Scan and D-Scan Imaging – t-TOFD or TOFD** – click on  or  or press  on front panel keyboard or **F3** on external keyboard – illustrative video is available at <http://www.sonotronndt.com/video.asp?VideID=4>
- ◆ **CB-Scan horizontal plane-view imaging and recording of defects for shear, surface, and guided wave inspection – t-FLOORMAP L or FLOORMAP L** click on  or  press  on front panel keyboard or **F4** on external keyboard – illustrative video is available at <http://www.sonotronndt.com/video.asp?VideID=3>

To return to **Main Recording Menu – Single Channel (CH 1)** click on  or press  or  on front panel keyboard or **Esc** or **F5** on external keyboard

## 6.3. Thickness Profile Imaging and Recording – t-BScan(Th) and BScan(Th)

### 6.3.1. Setup Pulser Receiver for Thickness Profile Imaging and Recording

UDS 3-5 Pulser Receiver window – main operating surface – appears on ISONIC 2007 screen upon clicking on  or . The following settings to be provided:

| #  | Parameter or Mode  | Submenu          | Required Settings   | Note  |
|----|--|------------------|---|---|
| 1  | aSwitch  | GATE A           | ON  |   |
| 2  | Gain<br>aThreshold   | BASICS<br>GATE A | Gain and aThreshold settings to provide receiving an echo from the minimal area of thickness degradation to be detected; height of the said echo to exceed aThreshold; signals from other reflectors less then defined one not to exceed aThreshold |   |
| 3  | DAC/TCG  | DAC/TCG          | DAC/TCG settings to meet requirements of the Inspection Procedure   |   |
| 4  | Pulser Mode  | PULSER           | Dual for dual element probes<br>Single for single element probes  |   |
| 5  | Tuning, Pulse Width, Firing Level, Damping                   | PULSER           | Tuning, Pulse Width, Firing Level, and Damping settings to provide optimal signal to noise ratio  | To synchronize with Gain and aThreshold setting procedure   |
| 6  | Filter, Frequency  | RECEIVER         | Filter and Frequency settings to match with probe's frequency   | To synchronize with Gain and aThreshold setting procedure   |
| 7  | Display  | RECEIVER         | Display mode may be either Full, RF, PosHalf, or NegHalf  | The same Display mode to be used for both Probe Delay determining and Thickness Profile Imaging                 |
| 8  | USVelocity   | BASIC            | USVelocity setting to be equal to actual value of ultrasound velocity in the object under test  |   |
| 9  | Probe Delay  | MEASURE          | Probe Delay setting to be equal to actual probe delay   | Probe delay may be determined according to paragraph 5.2.13.7 or 5.2.13.9 of this Operating Manual or similarly |
| 10 | Angle  | MEASURE          | Angle = 0°  |   |
| 11 | Meas Mode  | MEASURE          | Flank   |   |
| 12 | Range, Display Delay, AStart, aWidth                         | BASIC<br>GATE A  | Range, Display Delay, AStart, and aWidth settings to be performed with reference to the Region of Interest for t-BScan(Th) and BScan(Th) table below  |   |
| 13 | Settings for other parameters and modes have no significance |                  |   |   |

Upon completing click on  or press  on front panel keyboard or  on external keyboard

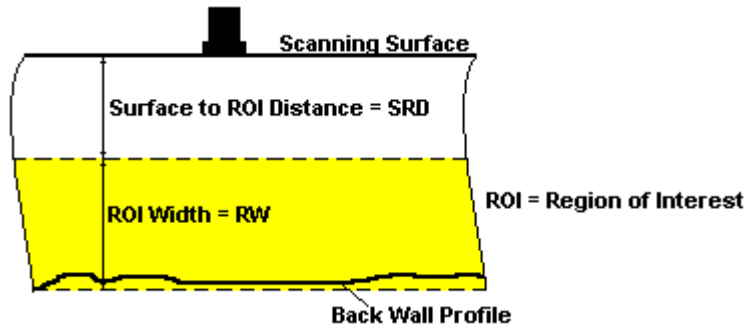

Case 1

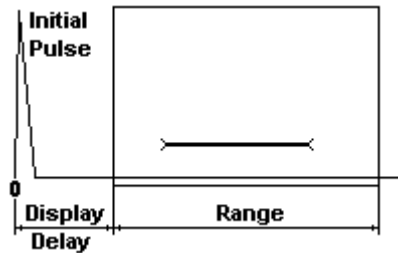

$$SRD = aStart$$

$$RW = aWidth$$

Case 2

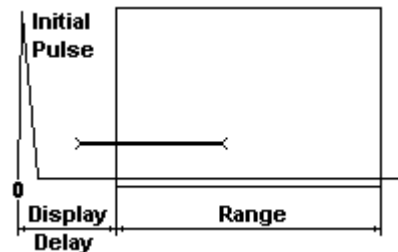

$$SRD = \frac{DisplayDelay}{2} \times USVelocity$$

$$RW = aStart + aWidth - SRD$$

Case 3

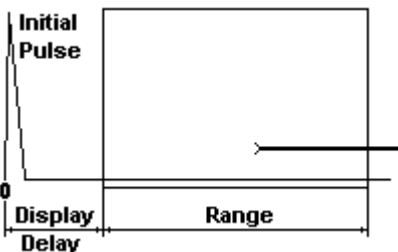

$$SRD = aStart$$

$$RW = \frac{DisplayDelay}{2} \times USVelocity + Range - aStart$$

Case 4

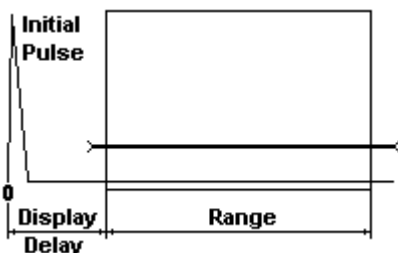

$$SRD = \frac{DisplayDelay}{2} \times USVelocity$$

$$RW = Range$$

Preferred embodiment

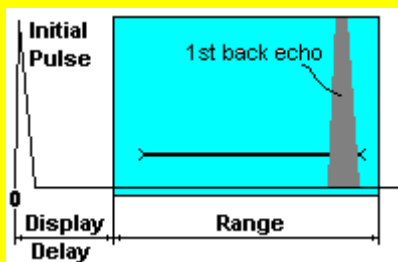

- ◆ **aStart** and **aWidth** setting to provide appearance of whole **Gate A** on the **A-Scan**
- ◆ **aWidth = (0.75...0.95) × Range**
- ◆ **First Back Echo** at the thickest area of object under test to be fully matching with Gate A
- ◆ **First Back Echo** at the thickest area of object under test to "occupy" 5-10% of the Gate A width on the **A-Scan**

## 6.3.2. Thickness Profile Imaging – Implementation

### 6.3.2.1. t-BScan(Th) – Prior to Scanning

t-BScan(Th) control panel is shown below

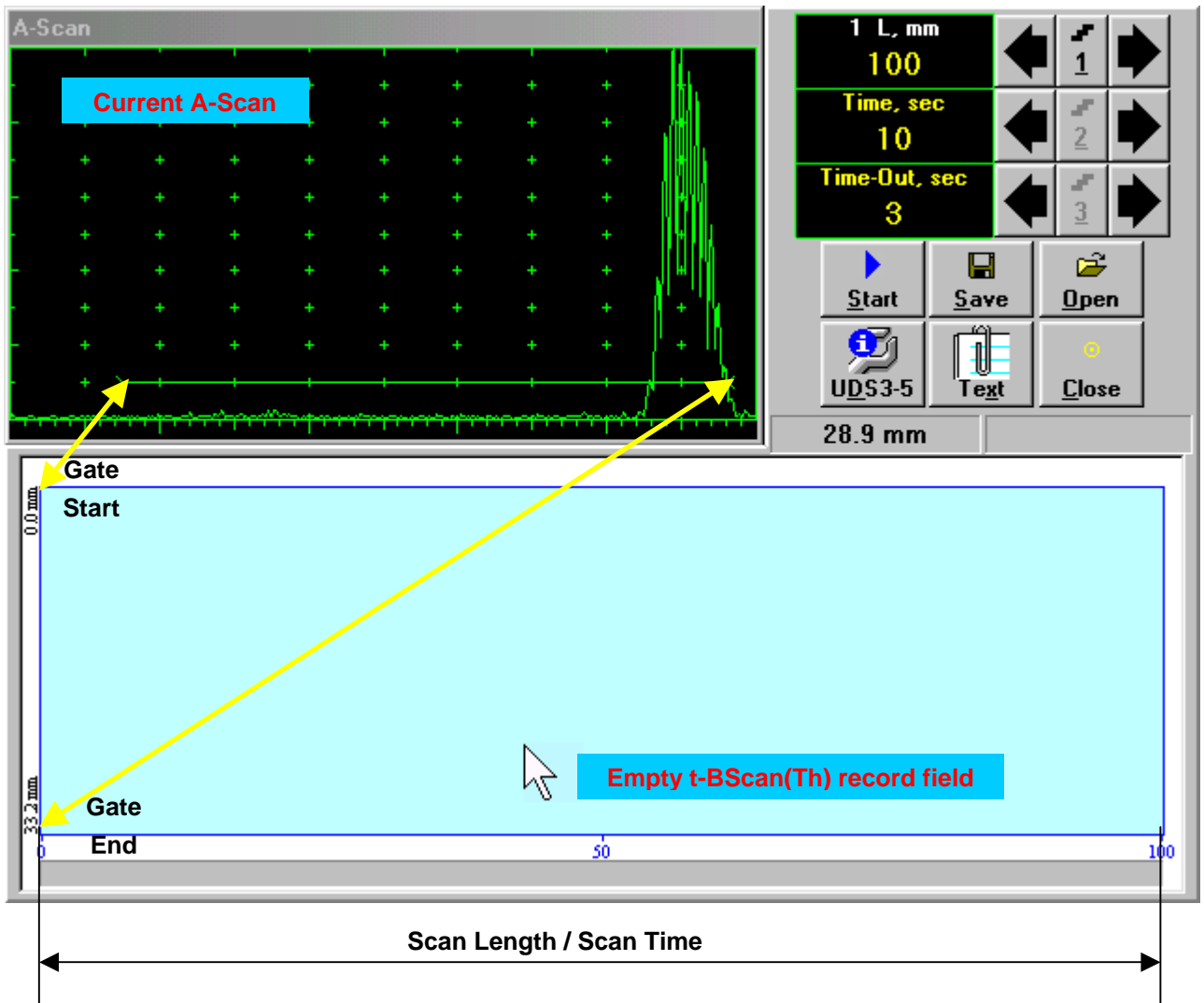

**Display Delay** and **Range** settings for current **A-Scan** to be used for the recording are equivalent to the same setting of **UDS 3-5 Pulser Receiver** precessing entering into **t-BScan(Th)** mode

## Scan Length and Scan Time

*Scan Length* – **L** represents length of section of test object to be displayed, over which probe will be scanning during recording period. **Time** (Scan Time) is the duration of recording period

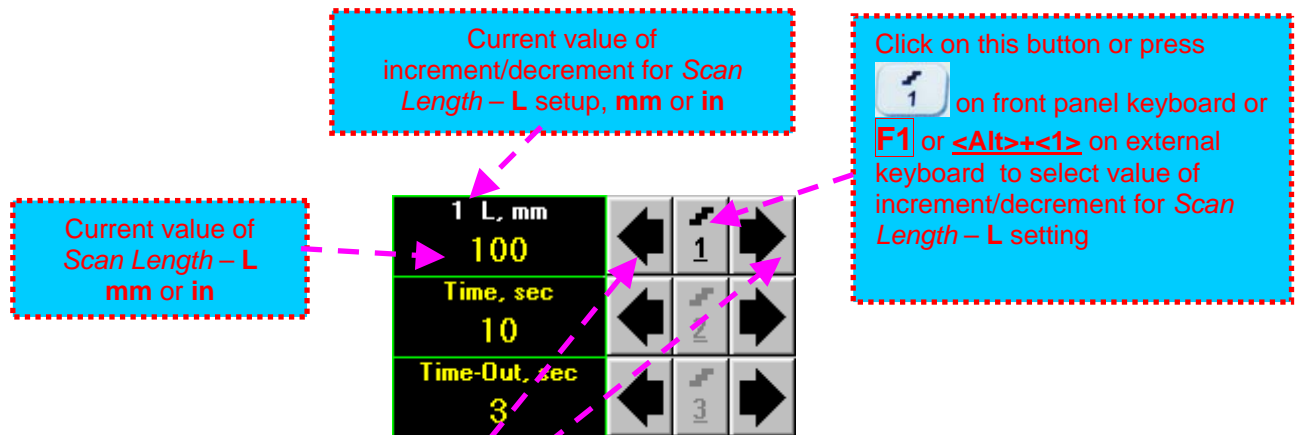

To control *Scan Length* – **L** the following manipulations are applicable:

- **Mouse / Touch Screen**

- Click on corresponding button

- **Keyboard**

- Press on front panel keyboard or **F1** on external keyboard ⇒ **L** fore color changes to white - then use , , , on front panel keyboard or , , , on external keyboard

- **Combined**

- Click on **L** ⇒ **L** fore color changes to white - then use , , , on front panel keyboard or , , , on external keyboard



The value of *Scan Length* – **L** is adjustable between 50 and 1000 **mm** or 2 and 40 **in**

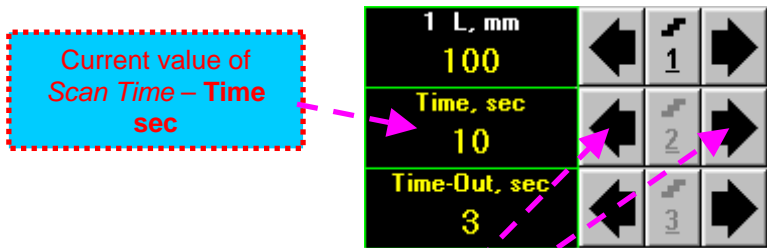









To control *Scan Time – Time* the following manipulations are applicable:









- **Mouse / Touch Screen**

- Click on corresponding **button**

- **Keyboard**

- Press  on front panel keyboard or **F2** on external keyboard ⇒ **Time** fore color changes to white - then use , , ,  on front panel keyboard or , , ,  on external keyboard

- **Combined**

- Click on **Time** ⇒ **Time** fore color changes to white - then use , , ,  on front panel keyboard or , , ,  on external keyboard

 The value of *Scan Time – Time* is adjustable between 5 and 60 **sec** in 1 **sec** increment/decrement



## Time-out

**Time-Out** is waiting time for intermissions precessing **t-BScan(Th)** recording, which starts unconditionally upon **Time-Out** period is over

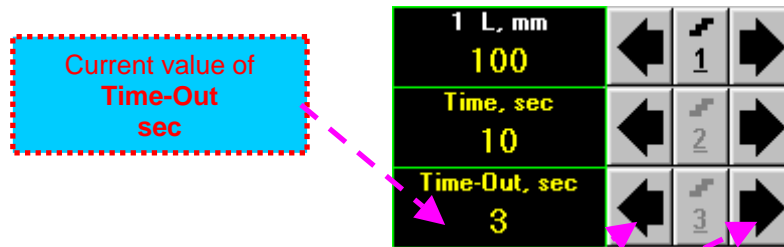

To control **Time-out** the following manipulations are applicable:









- **Mouse / Touch Screen**

- Click on corresponding **button**

- **Keyboard**

- Press  on front panel keyboard or **F3** on external keyboard ⇒ **Time-out** fore color changes to white - then use , , ,  on front panel keyboard or , , ,  on external keyboard

- **Combined**

- Click on **Time-Out** ⇒ **Time-Out** fore color changes to white - then use , , ,  on front panel keyboard or , , ,  on external keyboard



The value of **Time-Out** is adjustable between 0 and 15 **sec** in 1 **sec** increment/decrements

## Insert Text Note



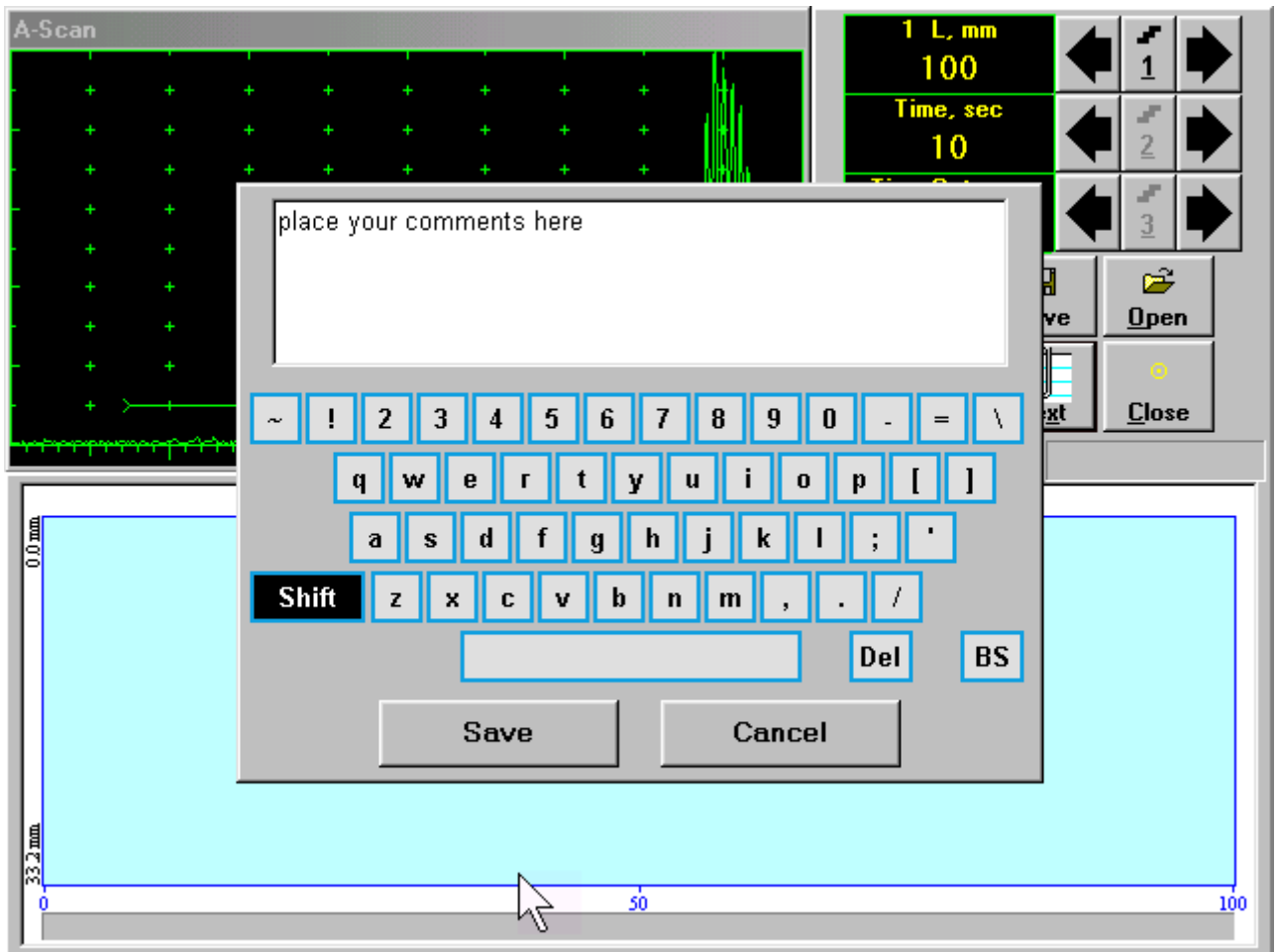

A text note may be entered to accompany **t-BScan(Th)** record. To proceed click on **Text** or press **<Alt>+<X>** on external keyboard



Type notes and comments to accompany scanning files: use either virtual keyboard appeared (touch screen or mouse) or external keyboard

Click on  to store typed note and to return to **t-BScan(Th)** control panel

Click on  or press  on front panel keyboard or **Esc** on external keyboard to negate typed note and to return to **t-BScan(Th)** control panel

## Preview UDS 3-5 Settings

UDS 3-5 Pulser Receiver settings for the **t-BScan(Th)** record may be previewed through clicking on





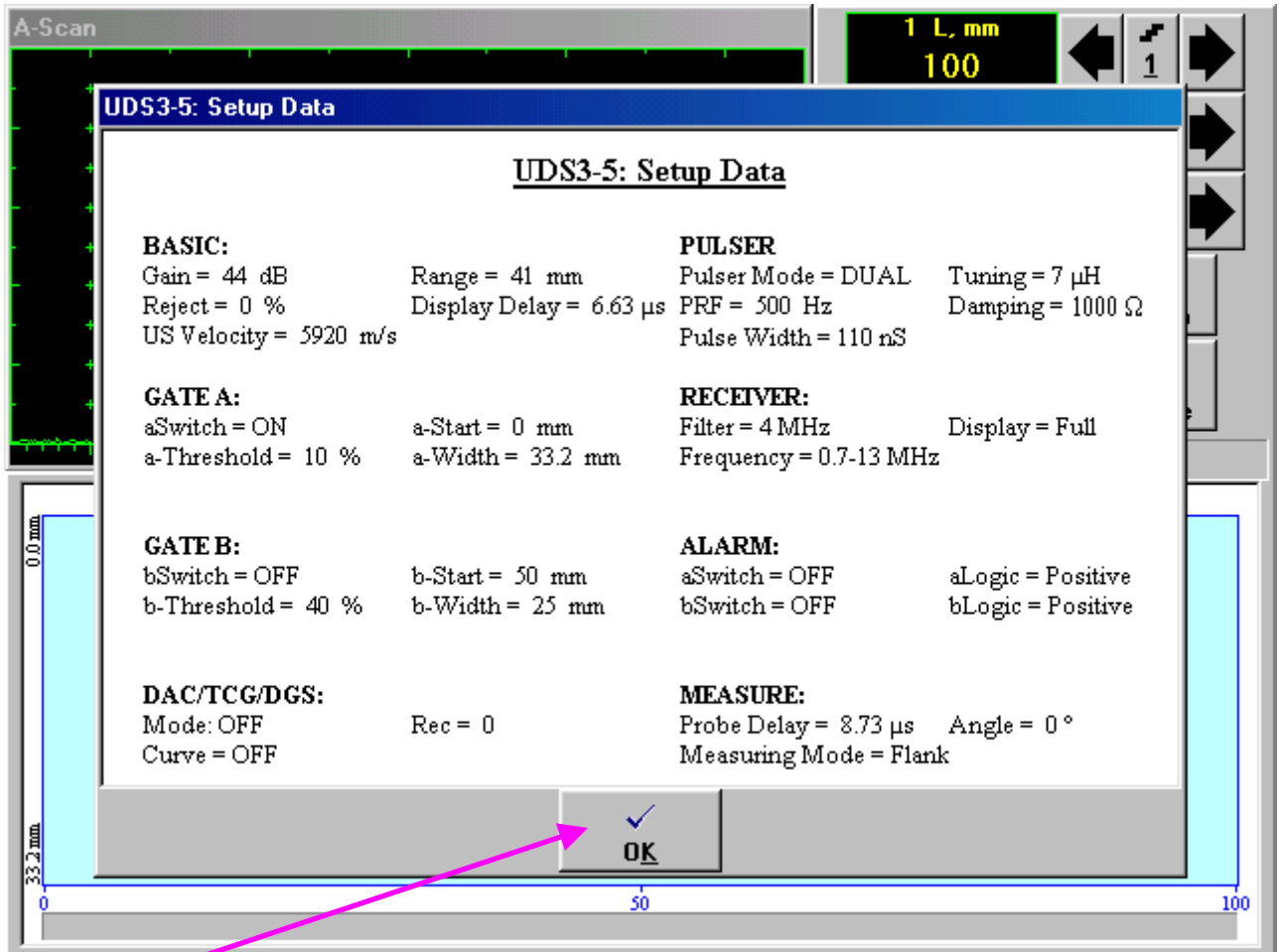



or pressing **<Alt>+<D>** on external keyboard . The corresponding window appears:





Click on  or press **<Alt>+<K>** or **ESC** on external keyboard to return to return to **t-BScan(Th)** control panel



### Start/Stop t-BScan(Th) recording

Click on  or press  on front panel keyboard or **F8** or **<Alt>+<S>** on external keyboard to start **t-BScan(Th)** recording



 button becomes invisible since **t-BScan(Th)** recording starts.  button occupies its position. Click on  or press  on front panel keyboard or **F8** or **<Alt>+<S>** on external keyboard to terminate **t-BScan(Th)** recording prior to automatic completion

 button becomes invisible after completion / termination of **t-BScan(Th)** record.  button returns to its position



### Save record into a file

Click on  or press  on front panel keyboard or **F12** or **<Alt>+<A>** on external keyboard to save captured **t-BScan(Th)** record accompanied with instrument calibration dump and text notes / comments into a file. Refer to paragraph 5.2.17 of this Operating Manual to proceed with file saving

### Open record from a file and starting postprocessing session

Click on  or press  on front panel keyboard or **F11** or **<Alt>+<O>** on external keyboard **t-B-Scan(Th)** record accompanied with instrument calibration dump and text notes / comments from a file. Refer to paragraph 5.2.18 of this Operating Manual to proceed with file opening. Refer to paragraph 6.3.2.5 of this Operating Manual to proceed with postprocessing

### Return to UDS 3-5 main operating surface

Click on  or press  on front panel keyboard or **<Alt>+<C>** or **Esc** on external keyboard

### 6.3.2.2. t-BScan(Th) – Scanning

- Apply probe to test object in the start point of selected scanning line

- Click on **Start** or press **I** on front panel keyboard or **F8** or **<Alt>+<S>** on external keyboard
- Guide probe over the scanning line synchronously with *Recording Progress Bar* – typical scanning progress display during is shown and explained below

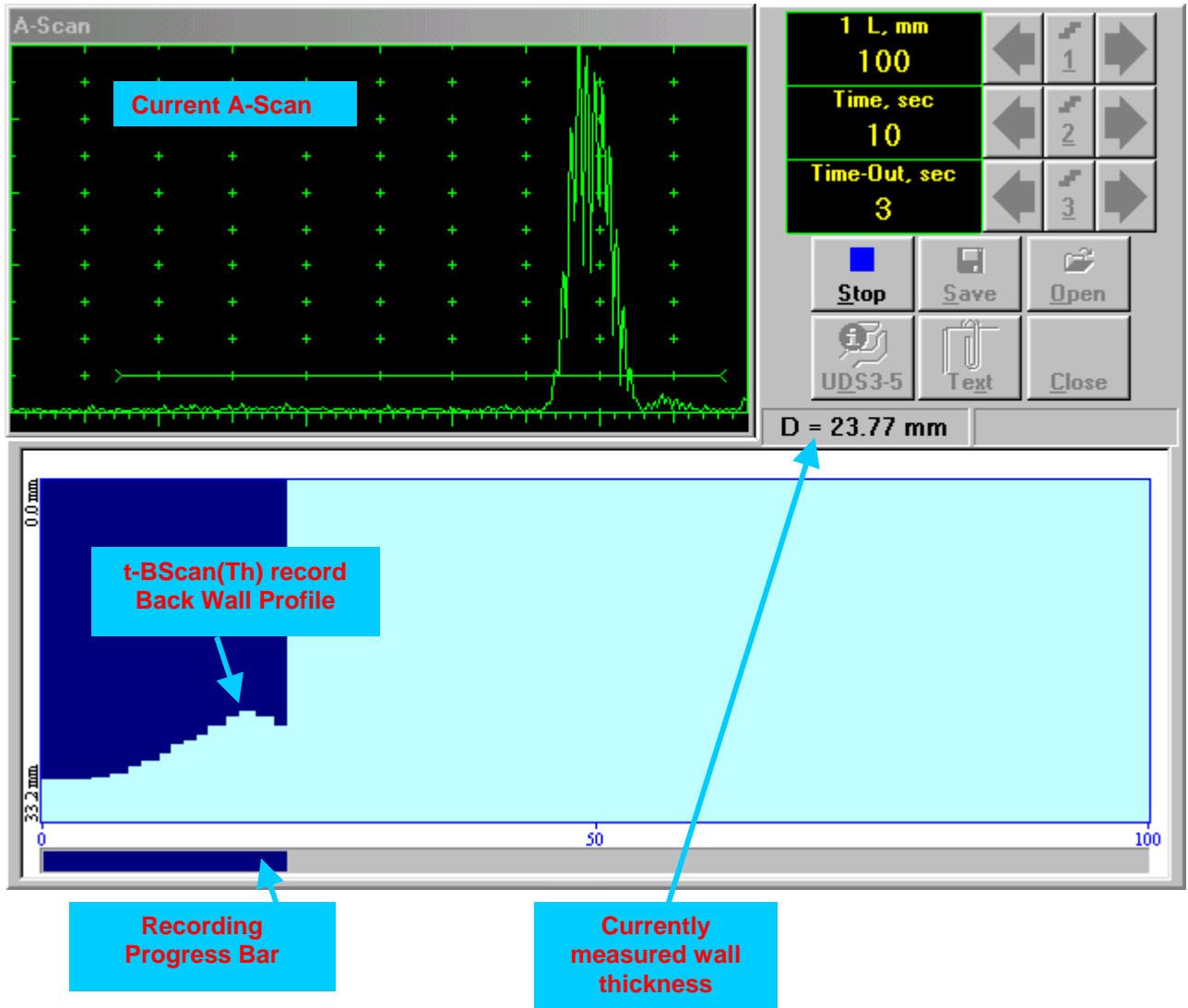

### 6.3.2.3. BScan(Th) – Prior to Scanning

BScan(Th) control panel is shown below

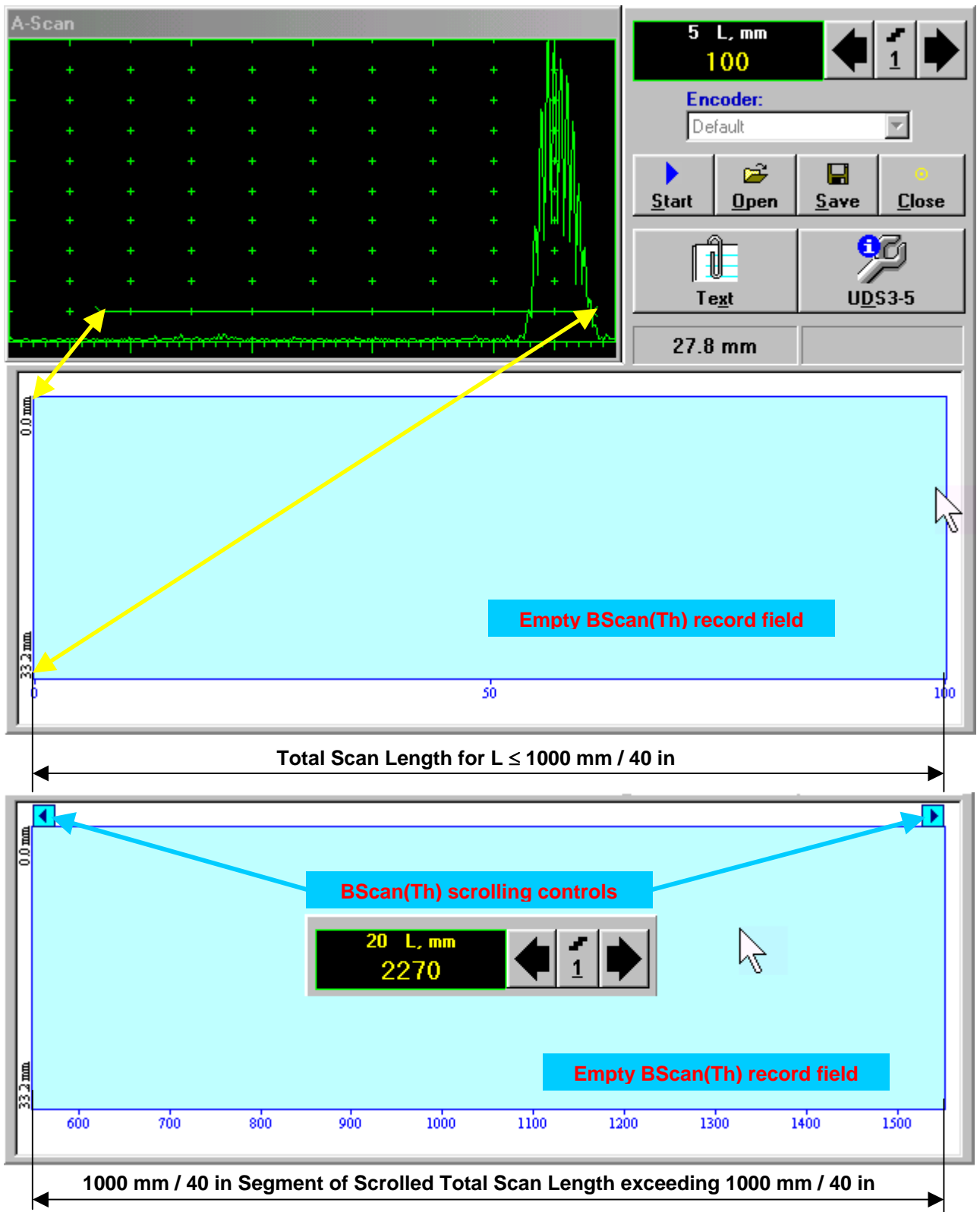

Display Delay and Range settings for current A-Scan to be used for the recording are equivalent to the same setting of UDS 3-5 Pulsar Receiver precessing entering into BScan(Th) mode

## Scan Length

*Scan Length – L* represents length of section of test object to be displayed, over which probe will be scanning during recording period

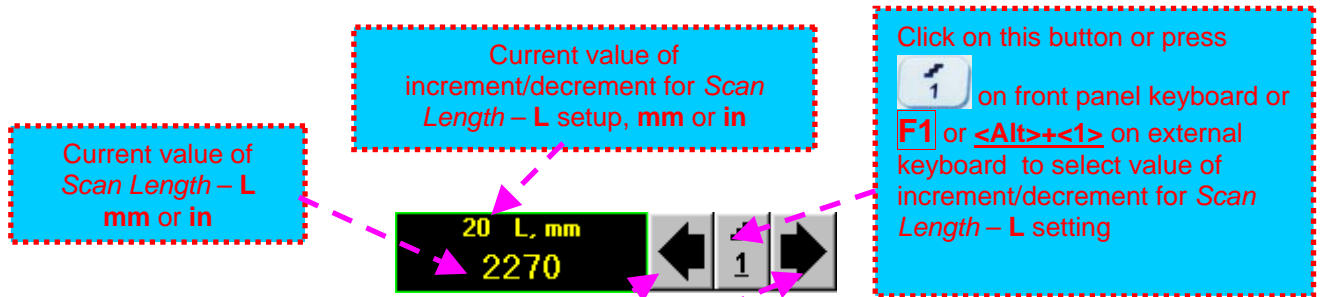

To control *Scan Length – L* the following manipulations are applicable:

- **Mouse / Touch Screen**

- Click on corresponding **button**

- **Keyboard**

- Press on front panel keyboard or **F1** on external keyboard ⇒ **L** fore color changes to white - then use , , , on front panel keyboard or , , , on external keyboard

- **Combined**

- Click on **L** ⇒ **L** fore color changes to white - then use , , , on front panel keyboard or , , , on external keyboard



The value of *Scan Length – L* is adjustable between 50 and 20000 **mm** or 2 and 800 **in**

## Encoder

Select encoder to be used through appropriate box



Clamp probe into encoder – refer to Chapter 7 of this Operating Manual

Connect encoder to its input on the rear panel of **ISONIC 2007** instrument



## Insert Text Note



Refer to paragraph 6.3.2.1 of this Operating Manual



## Preview UDS 3-5 Settings

Refer to paragraph 6.3.2.1 of this Operating Manual

### Start/Stop BScan(Th) recording



Click on  or press  on front panel keyboard or **F8** or **<Alt>+<S>** on external keyboard to start **BScan(Th)** recording

 button becomes invisible since **BScan(Th)** recording starts.  button occupies its position.



Click on  or press  on front panel keyboard or **F8** or **<Alt>+<S>** on external keyboard to terminate **BScan(Th)** recording

 button becomes invisible after termination of **BScan(Th)** record.  button returns to its position



### Save record into a file

Click on  or press  on front panel keyboard or **F12** or **<Alt>+<A>** on external keyboard to save captured **BScan(Th)** record accompanied with instrument calibration dump and text notes / comments into a file. Refer to paragraph 5.2.17 of this Operating Manual to proceed with file saving

### Open record from a file and starting postprocessing session

Click on  or press  on front panel keyboard or **F11** or **<Alt>+<O>** on external keyboard **B-Scan(Th)** record accompanied with instrument calibration dump and text notes / comments from a file. Refer to paragraph 5.2.18 of this Operating Manual to proceed with file opening. Refer to paragraph 6.3.2.5 of this Operating Manual to proceed with postprocessing



### Return to UDS 3-5 main operating surface

Click on  or press  on front panel keyboard or **<Alt>+<C>** or **Esc** on external keyboard



### 6.3.2.4. BScan(Th) – Scanning

- Apply probe equipped with an encoder to test object in the start point of selected scanning line

- Click on  or press  on front panel keyboard or **F8** or **<Alt>+<S>** on external keyboard
- Guide probe over the scanning line – typical scanning progress display is shown and explained below

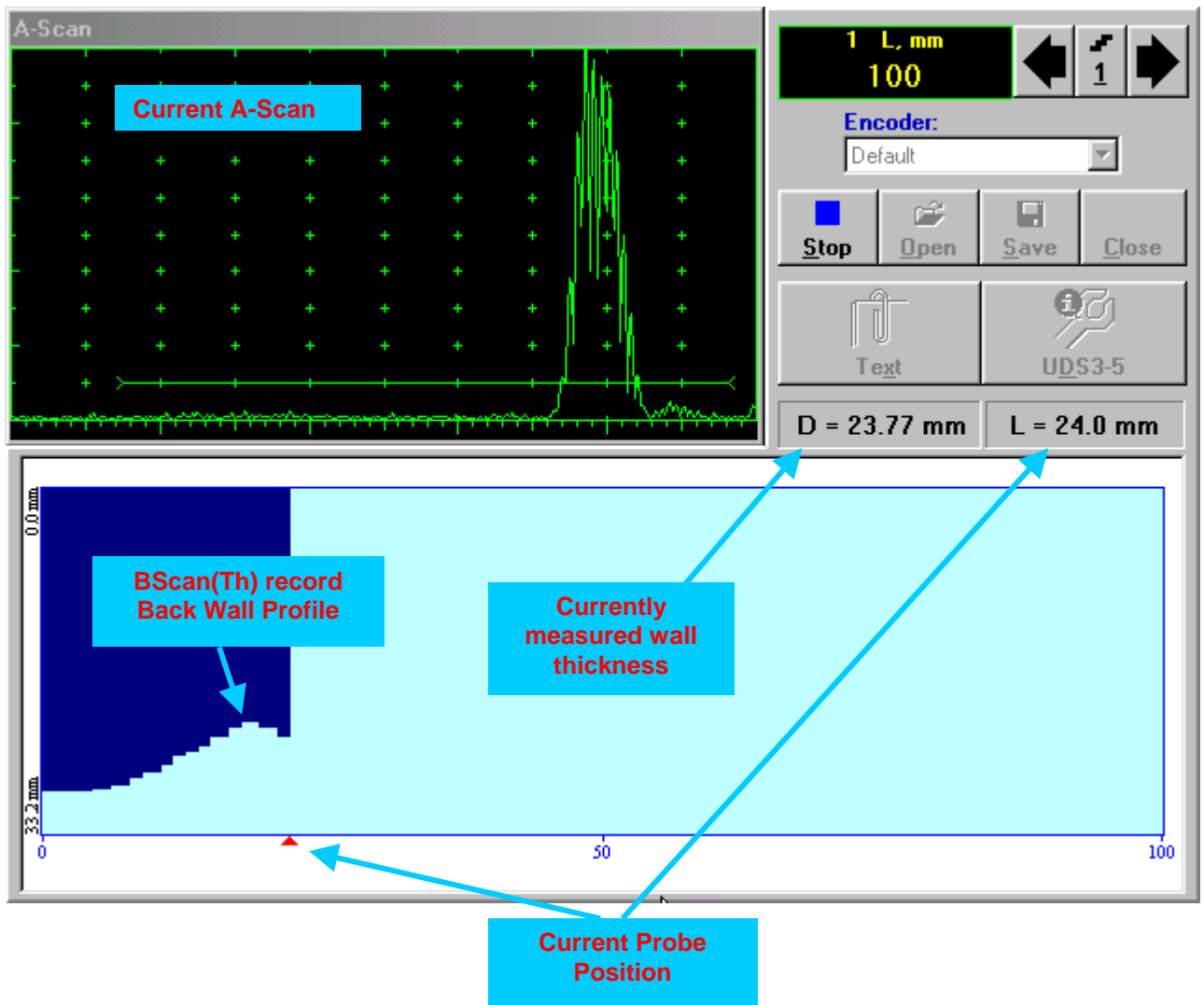

### 6.3.2.5. t-BScan(Th) / BScan(Th) – Postprocessing

Postprocessing of t-BScan(Th) / BScan(Th) records is featured with:



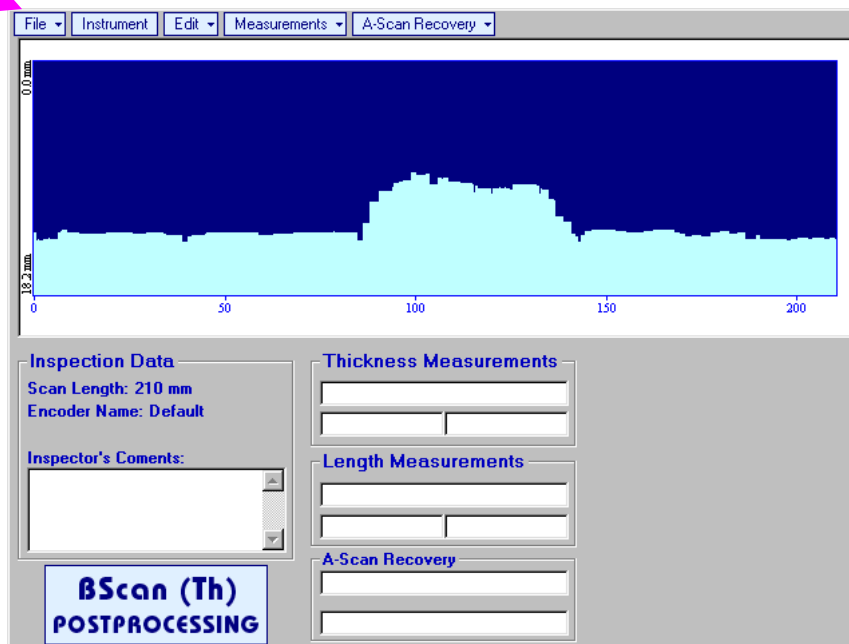

- ❑ Sizing thickness damages at any location along stored images (remaining thickness, thickness loss, and length of damage)
- ❑ Play-back and evaluation of **A-Scans** obtained and captured during thickness profile recording
- ❑ Reconstruction of thickness profile image for various **Gain** and / or **Gate A** settings

The screen as below appears upon opening file. All postprocessing procedures are performed through **menu bar** – touch screen stylus or front panel or external mouse to be used



#### Menu Bar Functions

- **File→Open** – opens new t-BScan(Th) / BScan(Th) file
- **File→Snapshots→Add Snapshot** – stores current postprocessing screen snapshot accompanied with appropriate settings and measurements into *postprocessing session memory stack*
- **File→Snapshots→Restore Snapshot** – recalls earlier stored postprocessing screen snapshot accompanied with appropriate settings and measurements from *postprocessing session memory stack*
- **File→Snapshots→Delete Snapshot** – deletes earlier stored postprocessing screen snapshot accompanied with appropriate settings and measurements from *postprocessing session memory stack*
- **File→Print** – prints out postprocessing screen snapshot(s) accompanied with appropriate settings and measurements
- **File→Exit** – returns to t-BScan(Th) / BScan(Th) control panel
- **Instrument** – indicates setup of UDS 3-5 Pulser Receiver used for scanning when file was created

- **A-Scan Recovery**→ON – generates *cursor representing sound path* of probe's central beam in the object under test that may be guided over **t-BScan(Th)** / **BScan(Th)** image using either touch screen stylus or mouse or  ,  on front panel keyboard or  ,  on external keyboard – corresponding **A-Scan** is recovered synchronously according to *sound path cursor* position. In the **A-Scan Recovery** field there are indicated coordinate (**L**) of *sound path cursor* along **t-BScan(Th)** / **BScan(Th)** record and corresponding *remaining thickness* value (**D**)

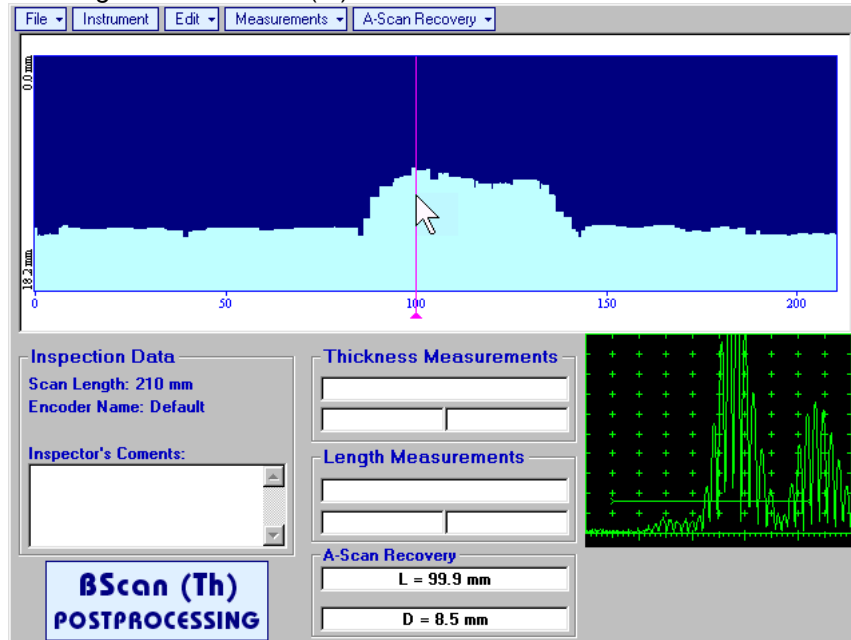











To fix position of *sound path cursor* with corresponding recovered **A-Scan** and *remaining thickness*



value left mouse click or release touch screen stylus or press  on front panel keyboard or **Enter** on external keyboard

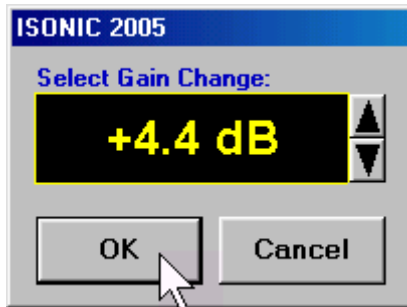

To interrupt recovery of **A-Scans** and empty **A-Scan Recovery** field right mouse click or press  on front panel keyboard or **Esc** on external keyboard

- **A-Scan Recovery**→OFF – erases *sound path cursor*, switches off recovered **A-Scan**, and empties **A-Scan Recovery** field

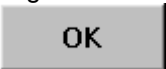



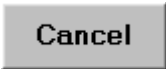





- Edit→Change Gain→ON** – generates *cursor representing sound path* of probe's central beam in the object under test that may be guided over **t-BScan(Th) / BScan(Th)** image using either touch screen stylus or mouse or ,  on front panel keyboard or ,  on external keyboard – corresponding **A-Scan** is recovered synchronously according to cursor position. To select reference **A-Scan** release touch screen stylus or left mouse click or press  on front panel keyboard or **Enter** on external keyboard – this generates subwindow allowing off-line re-adjusting of **Gain** for all **A-Scans** captured during **t-BScan(Th) / BScan(Th)** recording in  $\pm 6\text{dB}$  range with  $\pm 0.1\text{ dB}$  increments through clicking or pressing and holding on ,  or pressing ,  on front panel keyboard or ,  on external keyboard





During **Gain** re-adjusting reference **A-Scan** is modified accordingly. Upon completing re-adjusting **Gain** click on  or press  on front panel keyboard or **Enter** on external keyboard – this applies new **Gain** value to all captured **A-Scans** and redraws **t-BScan(Th) / BScan(Th)** image accordingly

To interrupt re-adjusting of **Gain** click on  or press  on front panel keyboard or **Esc** on external keyboard

- Edit→Change Gain→OFF** – negates **Gain** re-adjustment and returns to originally recorded **t-BScan(Th) / BScan(Th)** image and original **Gain** setting

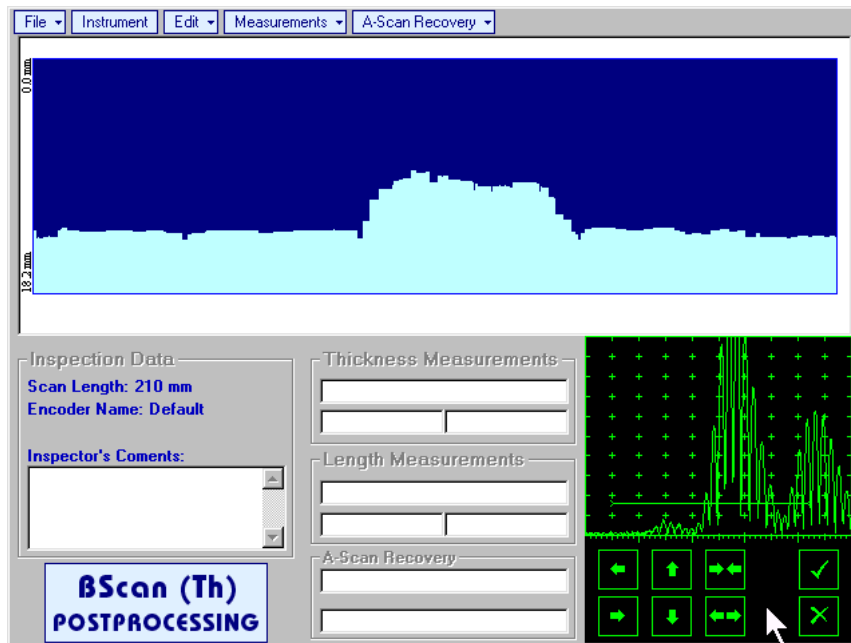
- Edit→ROI→ON** – generates *cursor representing sound path* of probe's central beam in the object under test that may be guided over **t-BScan(Th) / BScan(Th)** image using either touch screen stylus or mouse or ,  on front panel keyboard or ,  on external keyboard – corresponding **A-Scan** is recovered synchronously according to cursor position. To select reference **A-Scan** release touch screen stylus or left mouse click or press  on front panel keyboard or **Enter** on external keyboard – this generates off-line **Gate A** controls , , , , ,  allowing to redefine **Region Of Interest** for **t-BScan(Th) / BScan(Th)** imaging



Upon completing redefining of **Region Of Interest** click on  – this applies new **Gate A** to all captured **A-Scans** and updates **t-BScan(Th) / BScan(Th)** image accordingly

To interrupt selection of reference of **A-Scan** right mouse click or press  on front panel keyboard or **Esc** on external keyboard





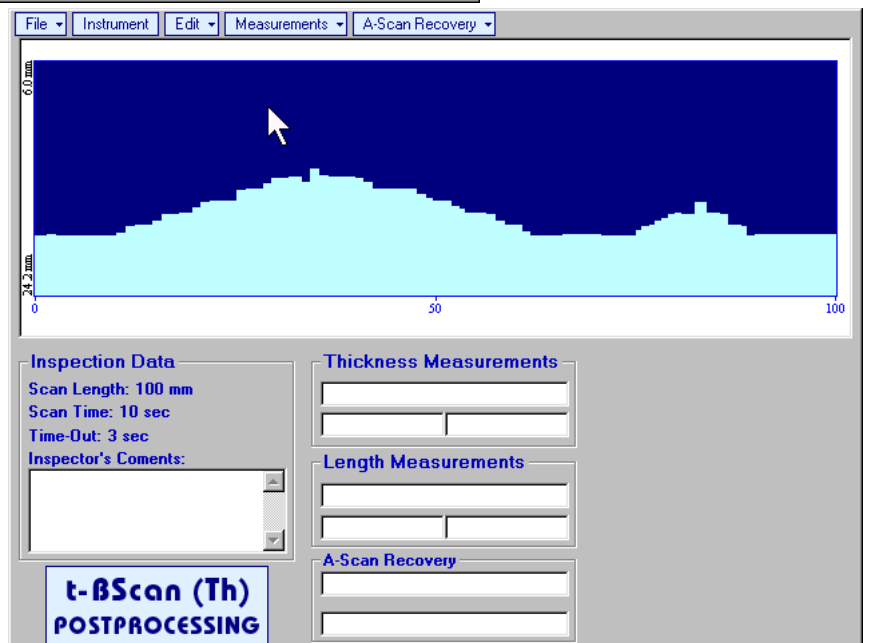
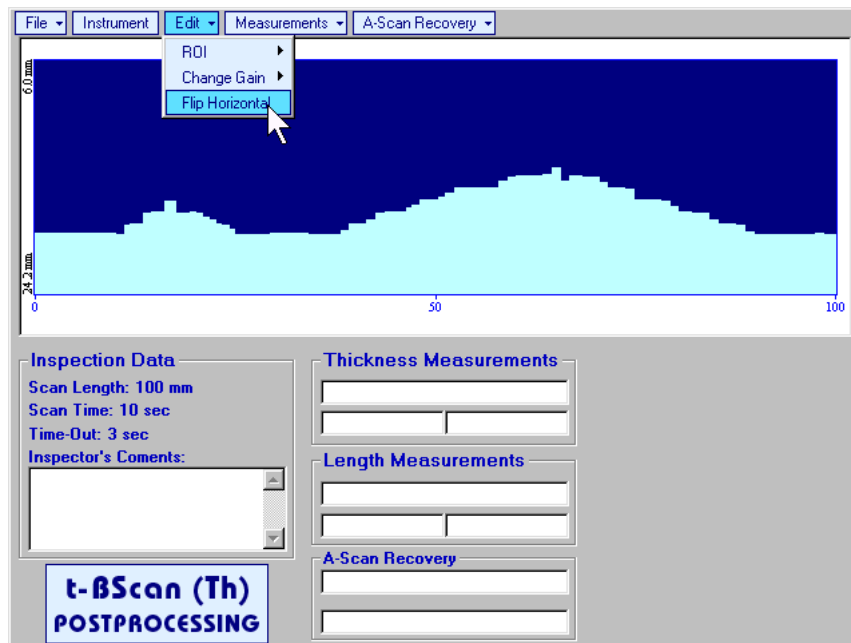

To interrupt re-adjustment of **Region Of Interest** after selection of reference of **A-Scan** click on 







- Edit→ROI→OFF** – negates **Gate A** re-adjustment and returns to originally recorded **t-BScan(Th) / BScan(Th)** image and original **Gate A** setting

- **Edit→Flip Horizontal** – reorders **A-Scans** captured during **t-BScan(Th)** / **BScan(Th)** recording in reverse succession and redraws **t-BScan(Th)** / **BScan(Th)** image accordingly. This service function may be useful for merging scans of neighboring sections of an object, which were scanned in opposite direction due to access conditions, etc



Applying of **Flip Horizontal** function empties *postprocessing session memory stack*

- Measurements→Length→ON** – generates first vertical cursor that may be guided over **t-BScan(Th)** / **BScan(Th)** image using either touch screen stylus or mouse or ,  on front panel keyboard or ,  on external keyboard . Coordinate of the first vertical cursor along **t-BScan(Th)** / **BScan(Th)** image (**Lg**) is indicated in the **Length Measurements** field. To fix position of the first vertical cursor left mouse click or release touch screen stylus or press  on front panel keyboard or **Enter** on external keyboard . To interrupt vertical cursor manipulations and empty **Length Measurements** field right mouse click or press  on front panel keyboard or **Esc** on external keyboard

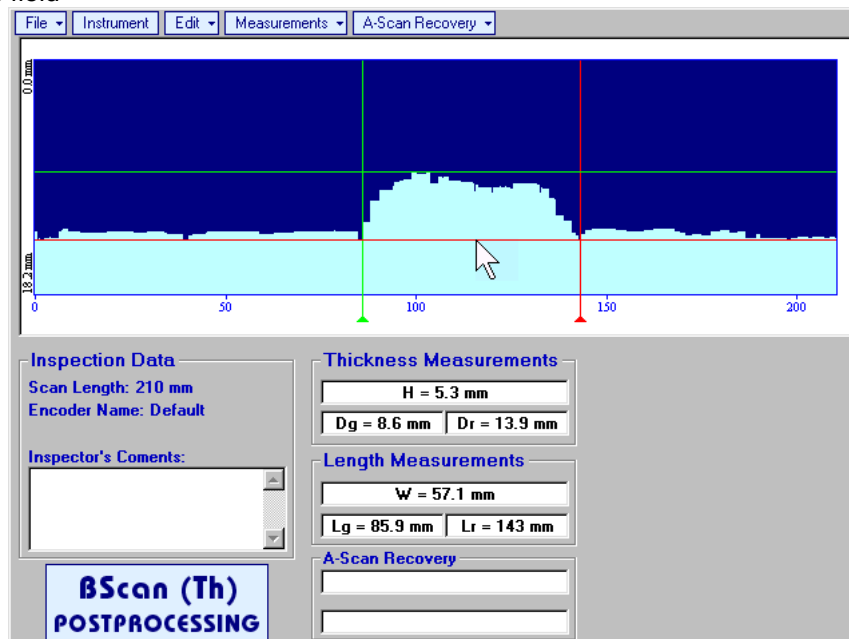

Second vertical cursor appears upon fixing first one, it may be manipulated by the same way. Coordinate of the second vertical cursor along **t-BScan(Th)** / **BScan(Th)** image (**Lr**) is indicated in the **Length Measurements** field along with parameter **W = Lr – Lg**. Parameter **W** represents length of defect provided that vertical cursors are placed appropriately
- Measurements→Length→OFF** – erases vertical cursors and empties **Length Measurements** field
- Measurements→Thickness→ON** – generates first horizontal cursor that may be guided over **t-BScan(Th)** / **BScan(Th)** image using either touch screen or mouse or ,  on front panel keyboard or ,  on external keyboard . Coordinate of the first horizontal cursor along **t-BScan(Th)** / **BScan(Th)** image (**Dg**) is indicated in the **Thickness Measurements** field. To fix position of the first horizontal cursor left mouse click or release touch screen stylus or press  on front panel keyboard or **Enter** on external keyboard . To interrupt horizontal cursor manipulations and empty **Thickness Measurements** field right mouse click or press  on front panel keyboard or **Esc** on external keyboard

Second horizontal cursor appears upon fixing first one, it may be manipulated by the same way. Coordinate of the second horizontal cursor along **t-BScan(Th)** / **BScan(Th)** image (**Dr**) is indicated in the **Thickness Measurements** field along with parameter **H = Dr – Dg**. Parameter **H** represents thickness loss provided that horizontal cursors are placed appropriately
- Measurements→Thickness→OFF** – erases horizontal cursors and empties **Thickness Measurements** field



## 6.4. B-Scan cross-sectional imaging and recording of defects for longitudinal and shear wave inspection – t-ABIScan or ABIScan

### 6.4.1. Setup Pulser Receiver for t-ABIScan or ABIScan Imaging and Recording

UDS 3-5 Pulser Receiver window – main operating surface – appears on ISONIC 2007 screen upon clicking on  or . The settings as below to be provided

#### 6.4.1.1. Straight Beam Probes

| #  | Parameter or Mode  | Submenu  | Required Settings  | Note  |
|----|--|----------|--|---|
| 1  | Gain   | BASICS   | Gain setting to be performed according to inspection procedure providing required echo heights from defects to be detected |   |
| 2  | DAC/TCG  | DAC/TCG  | DAC/TCG settings to meet requirements of inspection procedure  |   |
| 3  | Pulser Mode  | PULSER   | Dual for dual element probes<br>Single for single element probes   |   |
| 4  | Tuning, Pulse Width, Firing Level, Damping                   | PULSER   | Tuning, Pulse Width, Firing Level, and Damping settings to provide optimal signal to noise ratio                           | To synchronize with Gain setting procedure  |
| 5  | Filter, Frequency  | RECEIVER | Filter and Frequency settings to match with probe's frequency  | To synchronize with Gain setting procedure  |
| 6  | Display  | RECEIVER | Display setting may be either Full, RF, PosHalf, or NegHalf  | The same Display mode to be used for both Probe Delay determining and t-ABIScan / ABIScan Recording             |
| 7  | USVelocity   | BASIC    | USVelocity setting to be equal to actual value of ultrasound velocity in the object under test                             |   |
| 8  | Probe Delay  | MEASURE  | Probe Delay setting to be equal to actual probe delay  | Probe delay may be determined according to paragraph 5.2.13.7 or 5.2.13.9 of this Operating Manual or similarly |
| 9  | Angle  | MEASURE  | Angle = 0°   |   |
| 10 | Settings for other parameters and modes have no significance |          |  |   |

Click on  or press  on front panel keyboard or **F8** on external keyboard upon completing



### 6.4.1.2. Angle Beam Probes

| #  | Parameter or Mode  | Submenu  | Required Settings  | Note  |
|----|--|----------|--|---|
| 1  | Gain   | BASICS   | Gain setting to be performed according to inspection procedure providing required echo heights from defects to be detected |   |
| 2  | DAC/TCG  | DAC/TCG  | DAC/TCG settings to meet requirements of inspection procedure  |   |
| 3  | Pulser Mode  | PULSER   | Dual for dual element probes<br>Single for single element probes   |   |
| 4  | Tuning, Pulse Width, Firing Level, Damping                   | PULSER   | Tuning, Pulse Width, Firing Level, and Damping settings to provide optimal signal to noise ratio                           | To synchronize with Gain setting procedure  |
| 5  | Filter, Frequency  | RECEIVER | Filter and Frequency settings to match with probe's frequency  | To synchronize with Gain setting procedure  |
| 6  | Display  | RECEIVER | Display setting may be either Full, RF, PosHalf, or NegHalf  | The same Display mode to be used for both Probe Delay determining and t-ABIScan / ABIScan Recording                         |
| 7  | USVelocity   | BASIC    | USVelocity setting to be equal to actual value of ultrasound velocity in the object under test                             |   |
| 8  | Probe Delay  | MEASURE  | Probe Delay setting to be equal to actual probe delay  | Probe delay may be determined according to paragraph 5.2.13.5 or 5.2.13.6 or 5.2.13.9 of this Operating Manual or similarly |
| 9  | Angle  | MEASURE  | Angle setting to be equal to actual probe angle  |   |
| 10 | Settings for other parameters and modes have no significance |          |  |   |

Click on  or press  on front panel keyboard or **F8** on external keyboard upon completing

## 6.4.2. B-Scan Cross Sectional Imaging – Implementation

### 6.4.2.1. t-ABIScan – Prior to Scanning (Straight Beam Probes)

t-ABIScan control panel for straight beam probe is shown below

The screenshot displays the t-ABIScan control panel interface. At the top left, an 'A-Scan' window shows a graph with a red line and a blue line on a grid, with a 'Current A-Scan' label. To its right is a parameter control panel with four rows: '1 Thickness 43 mm', 'Skip# 0.5', '5 Length 200 mm', and '1 Time 7 s'. Each row has left and right arrow buttons and a central button with a number (1, 2, 3, 4). Further right is a 'Coloring' section with buttons for 'Pseudo', 'Pseudo2', 'Grayscale', and 'Thermal'. On the far right are icons for 'Text', 'UDS3-5', and 'Close'. Below these are 'Start', 'Open', and 'Save' buttons. The main window title is 't-ABIScan' and the date is '26-Jan-2006'.

The main display area is divided into two sections. The top section shows a horizontal axis from 0 to -200 with tick marks at -50, -100, and -150. A blue box labeled 'Empty t-ABIScan record field' is centered. Below the axis, a double-headed arrow indicates 'Scan Length not exceeding 600 mm or 24 in / Scan Time'.

The bottom section shows a horizontal axis from 0 to -600 with tick marks at -100, -200, -300, -400, and -500. A blue box labeled 'Empty t-ABIScan record field' is centered. Below the axis, a double-headed arrow indicates 'Segment of Scrolled Total Scan Length exceeding 600 mm or 24 in / Scan Time'. A blue box labeled 't-ABIScan scrolling controls' is positioned below the axis with arrows pointing to the left and right ends of the axis.

At the bottom of the interface, there is an information icon (i) and a text box: 'Display Delay for current A-Scan to be used for the recording is equal to Probe Delay setting in submenu MEASURE of UDS 3-5 Pulser Receiver precessing entering into t-ABIScan mode'.

## Thickness

**Thickness** setting defines the region of interest starting from the scanning surface and automatic **Range** setting for current **A-Scan** to be used for the recording: **Range = Thickness**. For objects whereas back echo is feasible it may be useful to key in **Thickness** value slightly exceeding actual thickness of the object under test – this will allow to record simultaneously defects signals and back echo itself. For the screenshot as above the actual thickness of the test piece is 40 mm while the **Thickness** setting is 43 mm thanks to such setting back echo is clearly resolved at the end of **A-Scan**

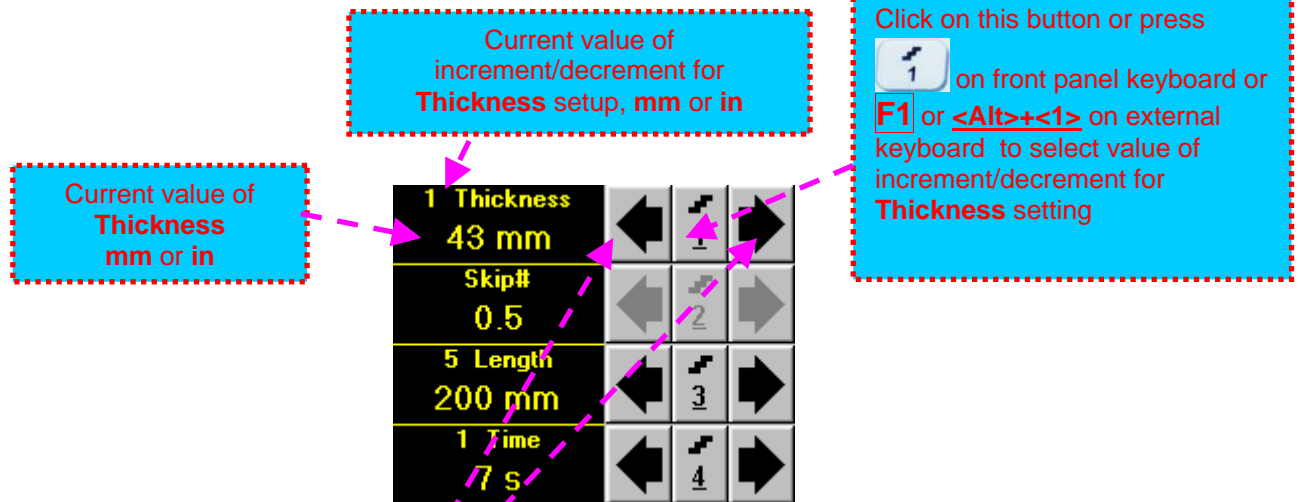

To control **Thickness** the following manipulations are applicable:

- **Mouse / Touch Screen**

- Click on corresponding **button**

- **Keyboard**

- Press on front panel keyboard or **F1** on external keyboard ⇒ **Thickness** fore color changes to white - then use , , , on front panel keyboard or , , , on external keyboard

- **Combined**

- Click on **Thickness** ⇒ **Thickness** fore color changes to white - then use , , , on front panel keyboard or , , , on external keyboard



The value of **Thickness** is adjustable between 5 and 300 **mm** or 0.2 and 12 **in** (expandable on special inquire)

## Skip #

This setting is ignored while using straight beam probes

## Scan Length and Scan Time

**Length** represents length of section of test object to be displayed, over which probe will be scanning during recording period. **Time** (Scan Time) is the duration of recording period

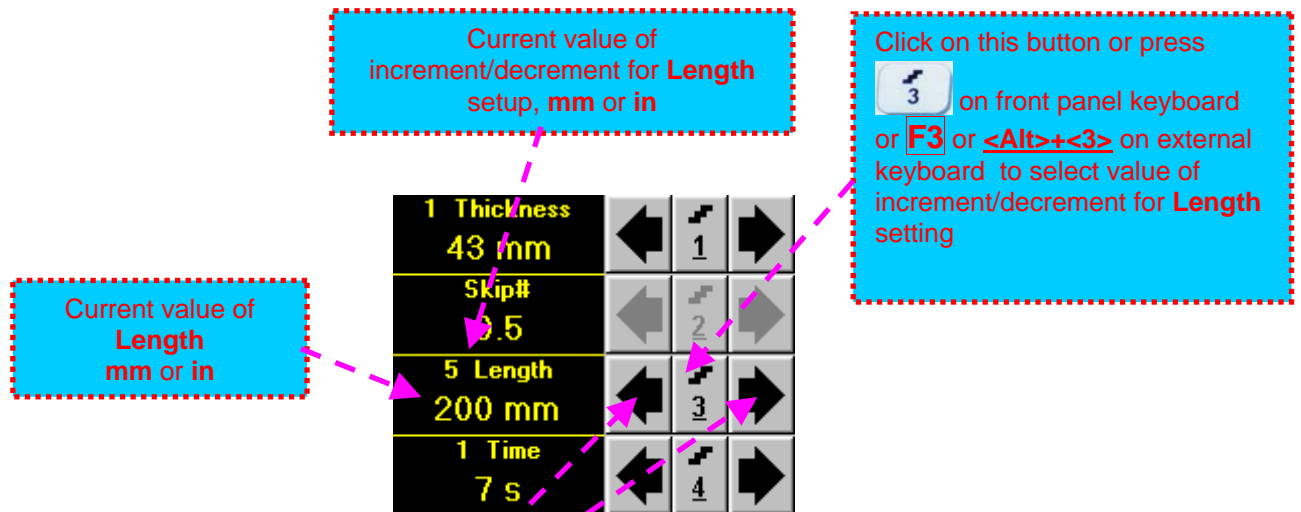

To control **Length** the following manipulations are applicable:

- **Mouse / Touch Screen**
  - Click on corresponding **button**
- **Keyboard**
  - Press on front panel keyboard or **F3** on external keyboard ⇒ **Length** fore color changes to white - then use , , , on front panel keyboard or , , , on external keyboard
- **Combined**
  - Click on **Length** ⇒ **Length** fore color changes to white - then use , , , on front panel keyboard or , , , on external keyboard



The value of **Length** is adjustable between 50 and 1000 **mm** or 2 and 40 **in**

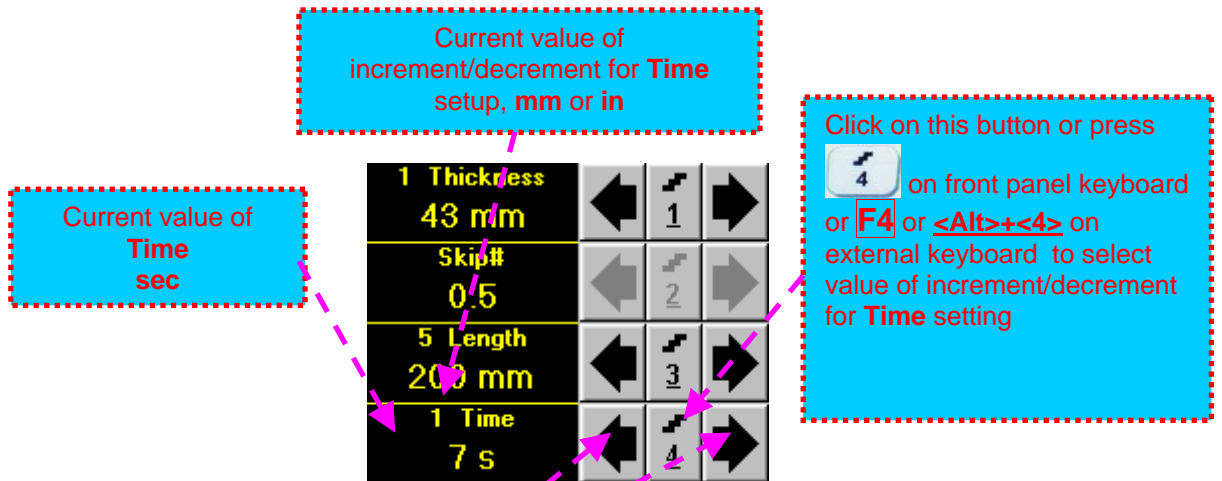

To control **Time** the following manipulations are applicable:

- **Mouse / Touch Screen**

- Click on corresponding **button**

- **Keyboard**

- Press on front panel keyboard or **F4** on external keyboard ⇒ **Time** fore color changes to white - then use , , , on front panel keyboard or , , , on external keyboard

- **Combined**

- Click on **Time** ⇒ **Time** fore color changes to white - then use , , , on front panel keyboard or , , , on external keyboard



The value of **Time** is adjustable between 5 and 60 **sec**

### Time-out

**Time-Out** is waiting time for intermissions predcessing **ABIScan** recording, which starts unconditionally upon **Time-Out** period is over. **Time-Out** has fixed duration of 3 sec for **t-ABIScan**

### Insert Text Note

Refer to paragraph 6.3.2.1 of this Operating Manual

### Preview UDS 3-5 Settings



Refer to paragraph 6.3.2.1 of this Operating Manual



### t-ABIScan Record Palette



There are four palettes available through click on appropriate button:





### Start/Stop t-ABIScan recording

Click on  or press  on front panel keyboard or **F8** or **<Alt>+<S>** on external keyboard to start **t-ABIScan** recording

 button becomes invisible since **t-ABIScan** recording starts.  button occupies its position.

Click on  or press  on front panel keyboard or **F8** or **<Alt>+<S>** on external keyboard to terminate **t-ABIScan** recording prior to automatic completion

 button becomes invisible after completion / termination of **t-ABIScan** record.  button returns to its position

### Save record into a file

Refer to paragraph 6.3.2.1 of this Operating Manual

### Open record from a file and starting postprocessing session

Refer to paragraph 6.3.2.1 of this Operating Manual

### Return to UDS 3-5 main operating surface

Refer to paragraph 6.3.2.1 of this Operating Manual

### 6.4.2.2. t-ABIScan – Scanning (Straight Beam Probes)

- Apply probe to test object in the start point of selected scanning line

- Click on **Start** or press **I** on front panel keyboard or **F8** or **<Alt>+<S>** on external keyboard
- Guide probe over the scanning line synchronously with *Probe Icon* moving with constant speed above t-ABIScan record field – typical scanning progress display during is shown and explained below

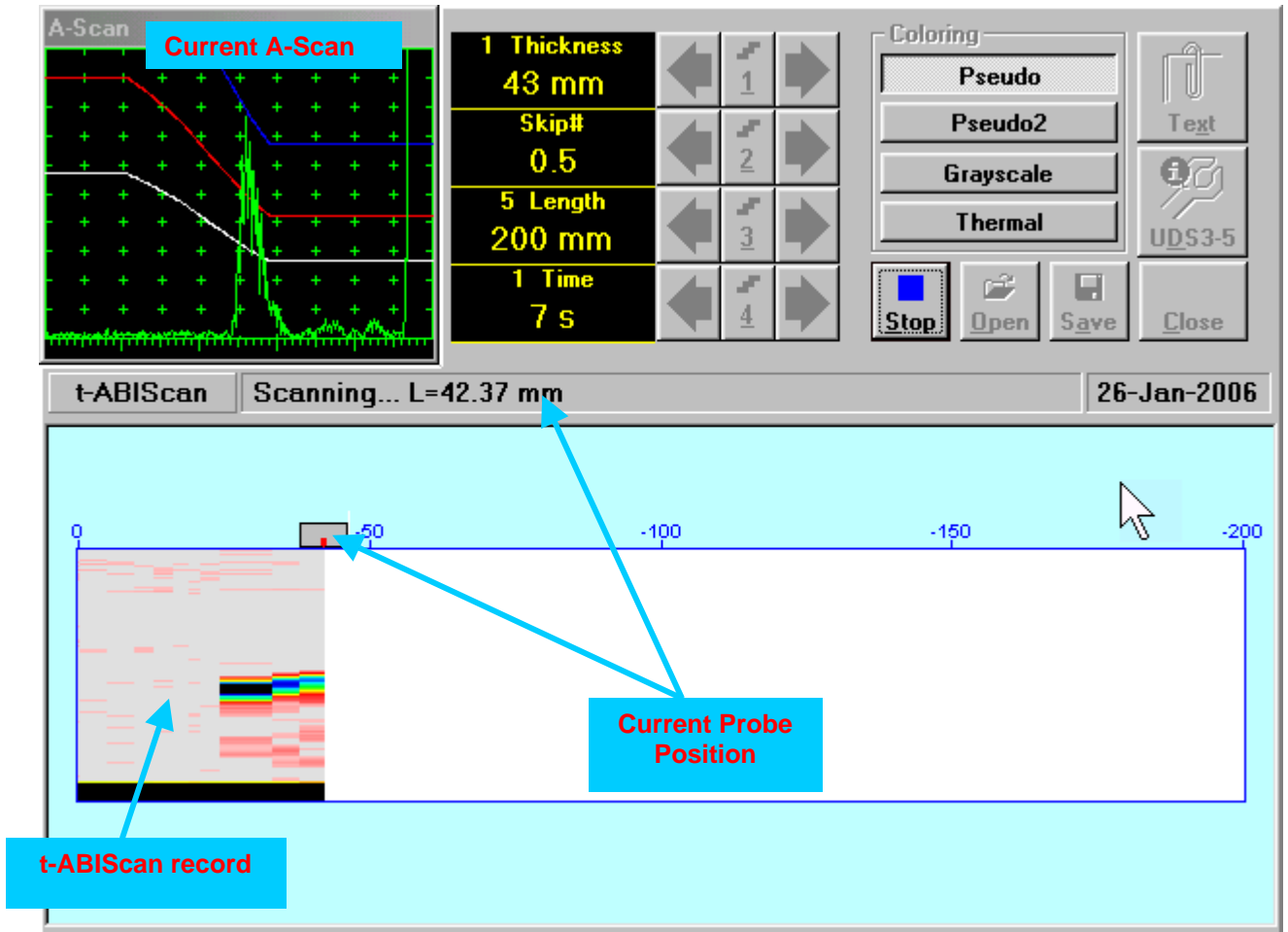

### 6.4.2.3. ABIScan – Prior to Scanning (Straight Beam Probes)

ABIScan control panel for straight beam probe is shown below

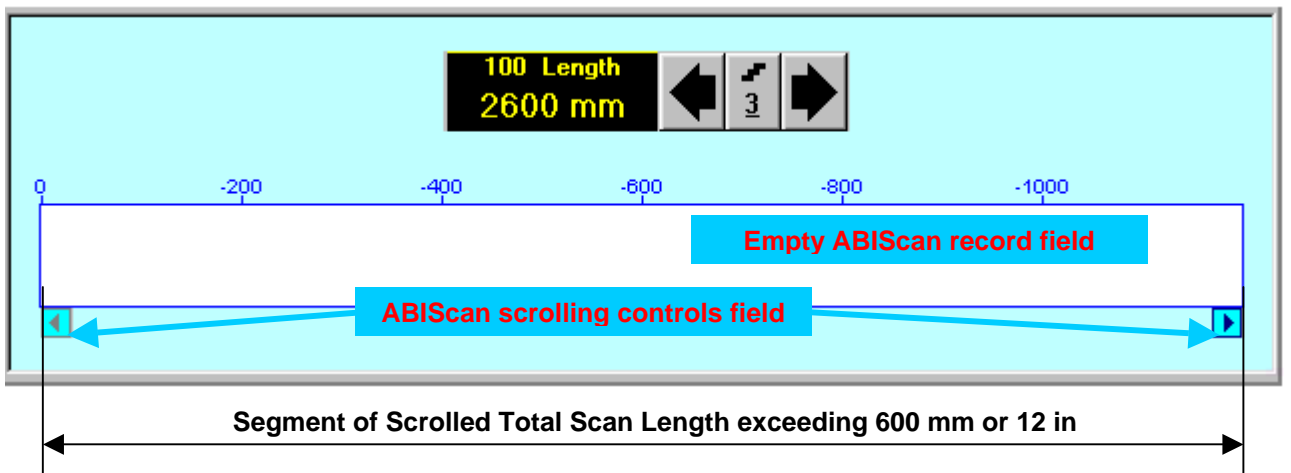
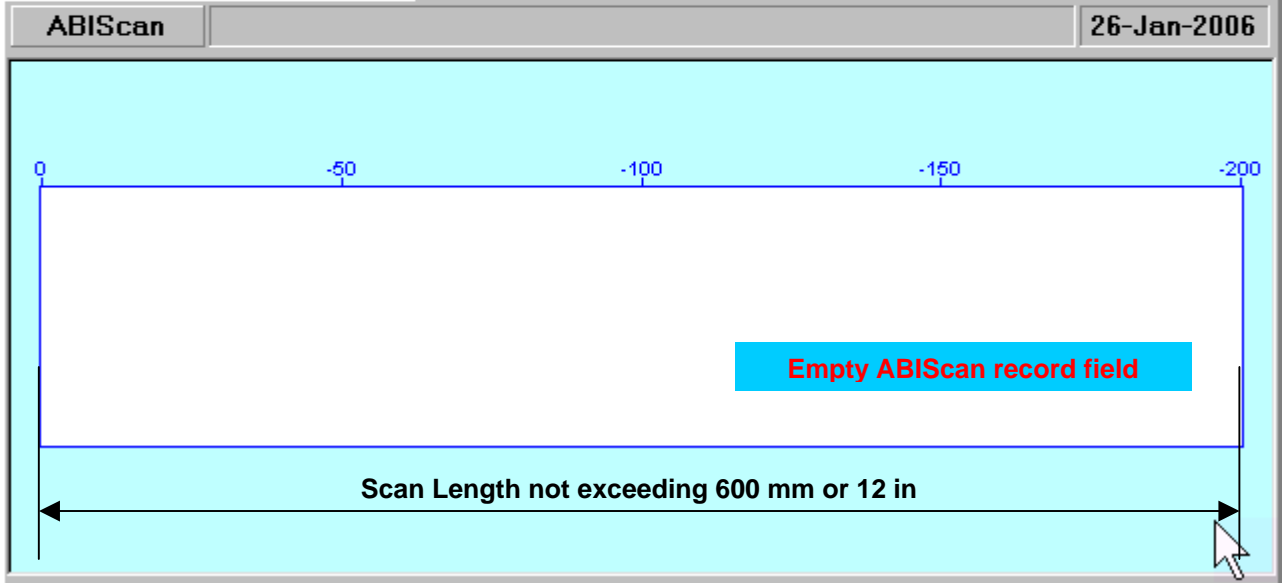
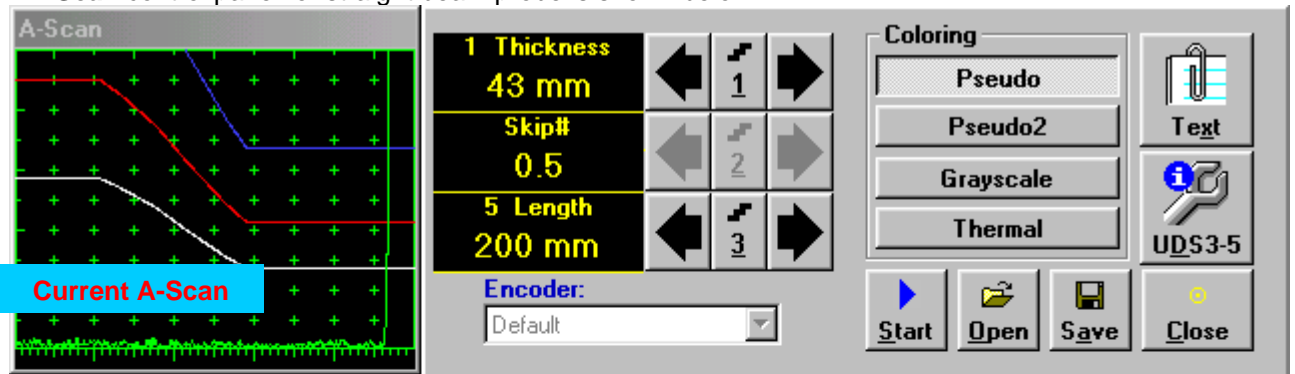

Display Delay for current A-Scan to be used for the recording is equal to **Probe Delay** setting in submenu **MEASURE** of **UDS 3-5 Pulser Receiver** precessing entering into **ABIScan** mode



## Thickness

**Thickness** setting defines the region of interest starting from the scanning surface and automatic **Range** setting for current **A-Scan** to be used for the recording: **Range = Thickness**. For objects whereas back echo is feasible it may be useful to key in **Thickness** value slightly exceeding actual thickness of the object under test – this will allow to record simultaneously defects signals and back echo itself. For the screenshot as above the actual thickness of the test piece is 40 mm while the **Thickness** setting is 43 mm thanks to such setting back echo is clearly resolved at the end of **A-Scan**

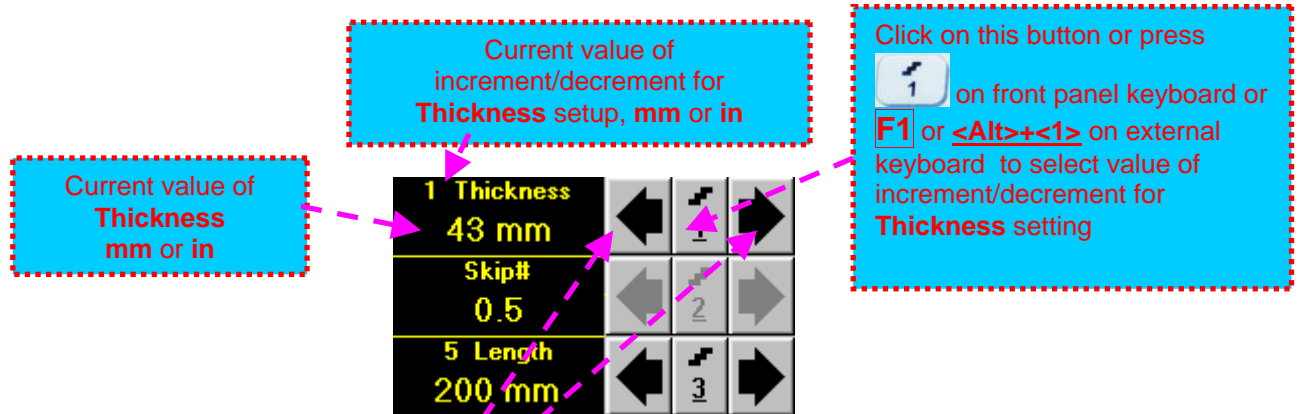









To control **Thickness** the following manipulations are applicable:









- **Mouse / Touch Screen**

- Click on corresponding button

- **Keyboard**

- Press  on front panel keyboard or **F1** on external keyboard ⇒ **Thickness** fore color changes to white - then use , , ,  on front panel keyboard or , , ,  on external keyboard

- **Combined**

- Click on **Thickness** ⇒ **Thickness** fore color changes to white - then use , , ,  on front panel keyboard or , , ,  on external keyboard



The value of **Thickness** is adjustable between 5 and 300 **mm** or 0.2 and 12 **in** (expandable on special inquire)

## Skip #

This setting is ignored while using straight beam probes

## Scan Length

**Length** represents length of section of test object to be displayed, over which probe will be scanning during recording period

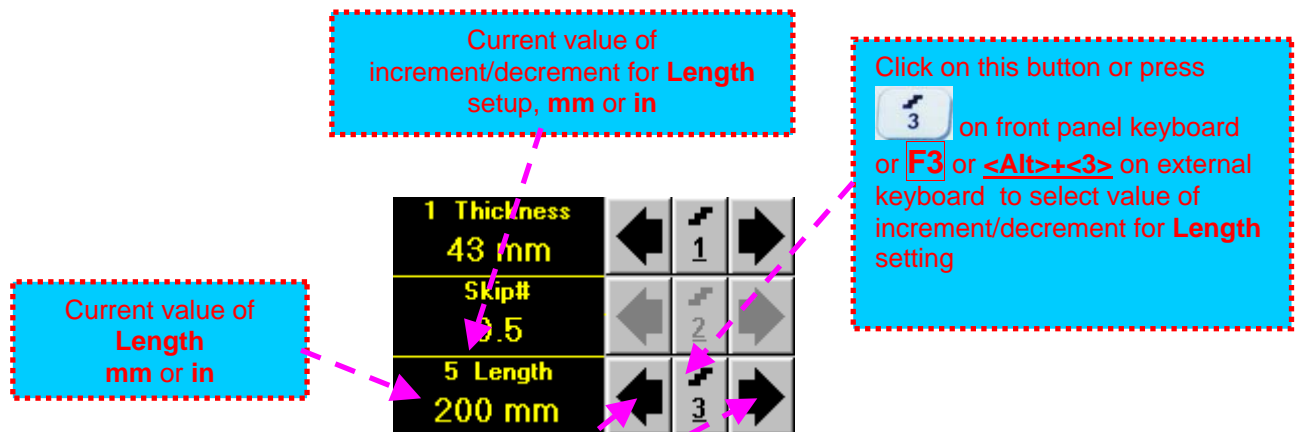









To control **Length** the following manipulations are applicable:









- **Mouse / Touch Screen**

- Click on corresponding **button**

- **Keyboard**

- Press  on front panel keyboard or **F3** on external keyboard ⇒ **Length** fore color changes to white - then use , , ,  on front panel keyboard or , , ,  on external keyboard

- **Combined**

- Click on **Length** ⇒ **Length** fore color changes to white - then use , , ,  on front panel keyboard or , , ,  on external keyboard



The value of **Length** is adjustable between 50 and 20000 **mm** or 2 and 800 **in**

## Encoder

Select encoder to be used through appropriate box



Clamp probe into encoder – refer to Chapter 7 of this Operating Manual

Connect encoder to its input on the rear panel of **ISONIC 2007** instrument

## Insert Text Note

Refer to paragraph 6.3.2.1 of this Operating Manual

## Preview UDS 3-5 Settings



Refer to paragraph 6.3.2.1 of this Operating Manual



## ABIScan Record Palette



There are four palettes available through click on appropriate button:





## Start/Stop ABIScan recording

Click on  or press  on front panel keyboard or **F8** or **<Alt>+<S>** on external keyboard to start **ABIScan** recording

 button becomes invisible since **ABIScan** recording starts.  button occupies its position.

Click on  or press  on front panel keyboard or **F8** or **<Alt>+<S>** on external keyboard to terminate **ABIScan** recording

 button becomes invisible after termination of **ABIScan** record.  button returns to its position

## Save record into a file

Refer to paragraph 6.3.2.1 of this Operating Manual

## Open record from a file and starting postprocessing session

Refer to paragraph 6.3.2.1 of this Operating Manual

## Return to UDS 3-5 main operating surface

Refer to paragraph 6.3.2.1 of this Operating Manual

#### 6.4.2.4. ABIScan – Scanning (Straight Beam Probes)

- Apply probe equipped with an encoder to test object in the start point of selected scanning line

- Click on **Start** or press **I** on front panel keyboard or **F8** or **<Alt>+<S>** on external keyboard
- Guide probe over the scanning line – typical scanning progress display during is shown and explained below

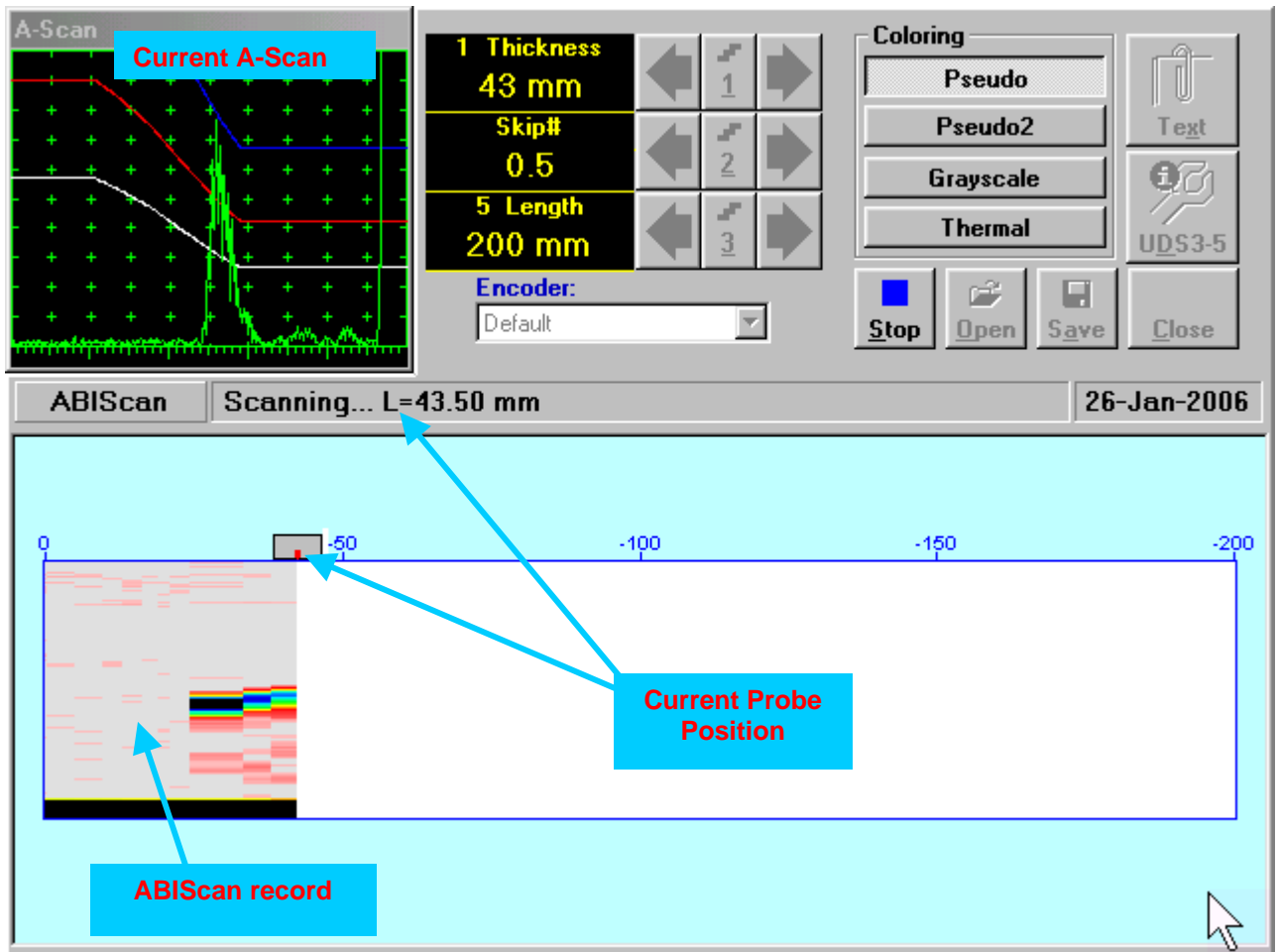

### 6.4.2.5. t-ABIScan – Prior to Scanning (Angle Beam Probes)

t-ABIScan control panel for angle beam probe is shown below

The screenshot shows the t-ABIScan control panel interface. On the left, an 'A-Scan' plot displays a red curve on a grid of green crosses, with a blue box labeled 'Current A-Scan' overlaid. To the right of the plot is a parameter control panel with four rows of settings, each with left and right arrow buttons and a central numeric keypad:

- 5 Thickness: 40 mm (value 1)
- Skip#: 0.5 (value 2)
- 5 Length: 80 mm (value 3)
- 1 Time: 10 s (value 4)

Further right is a 'Coloring' section with buttons for 'Pseudo', 'Pseudo2', 'Grayscale', and 'Thermal'. Below these are 'Start', 'Open', 'Save', and 'Close' buttons. On the far right, there are icons for 'Text', 'UDS3-5', and 'Close'. At the bottom of the control panel, the text 't-ABIScan' is on the left and '26-Jan-2006' is on the right.

Below the control panel, two diagrams illustrate scan length constraints. The first diagram shows a horizontal axis with markers at 50, 0, and -50. A double-headed arrow spans from 50 to -50, labeled 'Full Scan Length / Scan Time For Total Length of t-ABIScan Record Not Exceeding 600 mm or 24 in'. A blue box labeled 'Empty ABIScan record field' is positioned below this arrow. A longer double-headed arrow below the axis is labeled 'Total Length of t-ABIScan Record Not Exceeding 600 mm or 24 in'.

The second diagram shows a horizontal axis with markers at -100, -200, -300, -400, -500, and -600. A double-headed arrow spans from -100 to -600, labeled 'Segment of Scrolled Total Scan Length / Scan Time and t-ABIScan Record For Total Length of ABIScan Record Exceeding 600 mm or 24 in'. A blue box labeled 'Empty ABIScan record' is positioned below this arrow. A blue box labeled 'ABIScan scrolling controls field' is positioned above the axis, with arrows pointing to the left and right ends of the axis.



- ❑ Display Delay for current A-Scan to be used for the recording is equal to Probe Delay setting in submenu MEASURE of UDS 3-5 Pulsar Receiver preceeding entering into t-ABIScan mode
- ❑ Total Length of t-ABIScan Record is determined automatically according to:
  - Total Length of t-ABIScan Record = Total Scan Length + 2 \* Skip # \* Thickness \* Tan (Angle) whereas
  - ◆ Thickness, Skip #, and Total Scan Length = Length are the settings of t-ABIScan control panel
  - ◆ Angle is setting in submenu MEASURE of UDS 3-5 Pulsar Receiver preceeding entering into t-ABIScan mode

## Thickness and Skip #

**Thickness** and **Skip #** settings define the region of interest starting from the scanning surface and automatic **Range** setting for current **A-Scan** to be used for the recording:

$$\text{Range} = 2 \times \text{Skip \#} \times \text{Thickness} \times \text{Cos (Angle)}$$

whereas

- ◆ **Thickness** and **Skip #** are the settings of **t-ABIScan** control panel
- ◆ **Angle** is setting in submenu **MEASURE** of **UDS 3-5 Pulsar Receiver** precessing entering into **t-ABIScan** mode

For objects with parallel surfaces the actual **Thickness** value to be entered for full skip inspection (**Skip # = 1**)

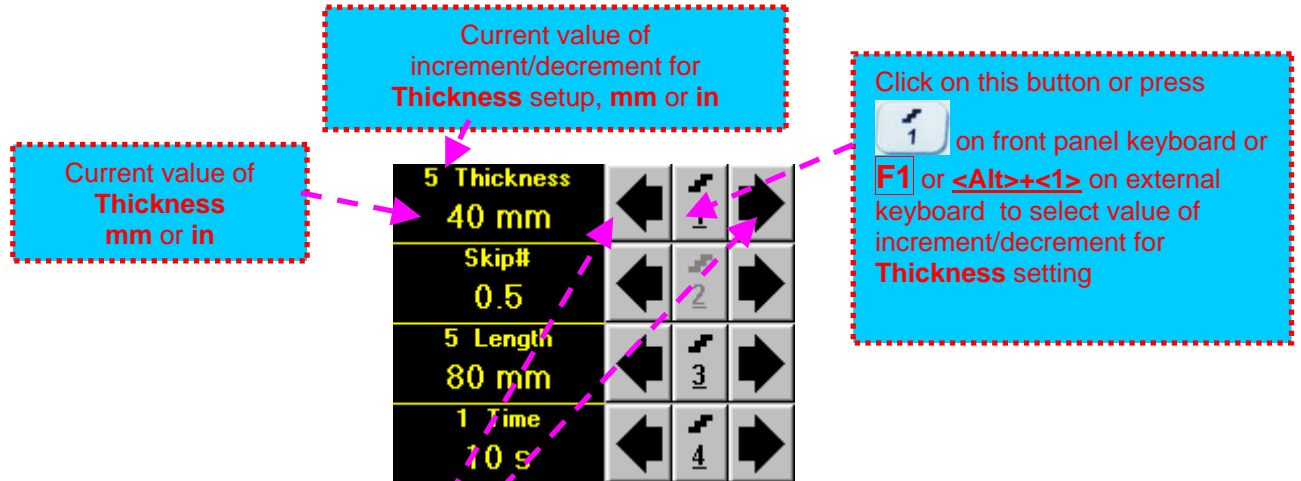





To control **Thickness** the following manipulations are applicable:









- **Mouse / Touch Screen**

- Click on corresponding **button**

- **Keyboard**

- Press  on front panel keyboard or **F1** on external keyboard ⇒ **Thickness** fore color changes to white - then use , , ,  on front panel keyboard or , , ,  on external keyboard

- **Combined**

- Click on **Thickness** ⇒ **Thickness** fore color changes to white - then use , , ,  on front panel keyboard or , , ,  on external keyboard



The value of **Thickness** is adjustable between 5 and 300 **mm** or 0.2 and 12 **in** (expandable on special inquire)

## Skip #

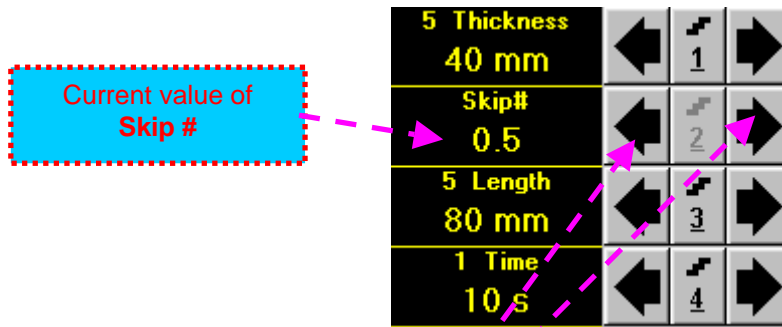









To control **Skip #** the following manipulations are applicable:







- **Mouse / Touch Screen**

- Click on corresponding **button**

- **Keyboard**

- Press  on front panel keyboard or **F2** on external keyboard ⇒ **Skip #** fore color changes to white - then use , , ,  on front panel keyboard or , , ,  on external keyboard

- **Combined**

- Click on **Skip #** ⇒ **Skip #** fore color changes to white - then use , , ,  on front panel keyboard or , , ,  on external keyboard









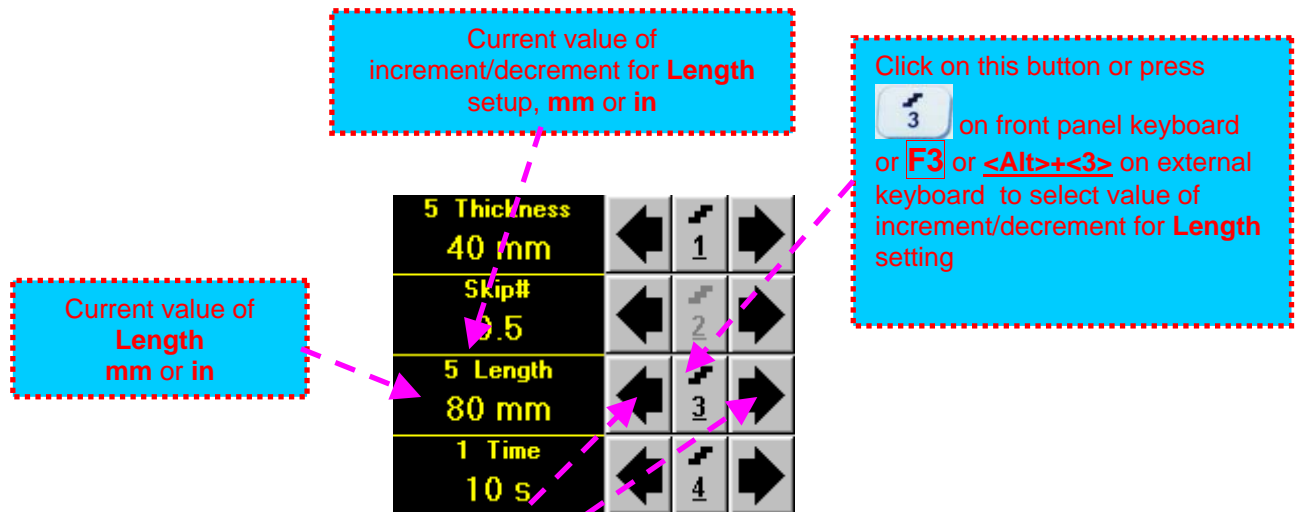









The **Skip #** setting may be **0.5** – half skip insonification or **1** – full skip insonification

## Scan Length and Scan Time

**Length** represents length of section of test object to be displayed, over which probe will be scanning during recording period. **Time** (Scan Time) is the duration of recording period



To control **Length** the following manipulations are applicable:

- **Mouse / Touch Screen**
  - Click on corresponding **button**
- **Keyboard**
  - Press  on front panel keyboard or **F3** on external keyboard ⇒ **Length** fore color changes to white - then use , , ,  on front panel keyboard or , , ,  on external keyboard
- **Combined**
  - Click on **Length** ⇒ **Length** fore color changes to white - then use , , ,  on front panel keyboard or , , ,  on external keyboard



The value of **Length** is adjustable between 50 and 1000 **mm** or 2 and 40 **in**



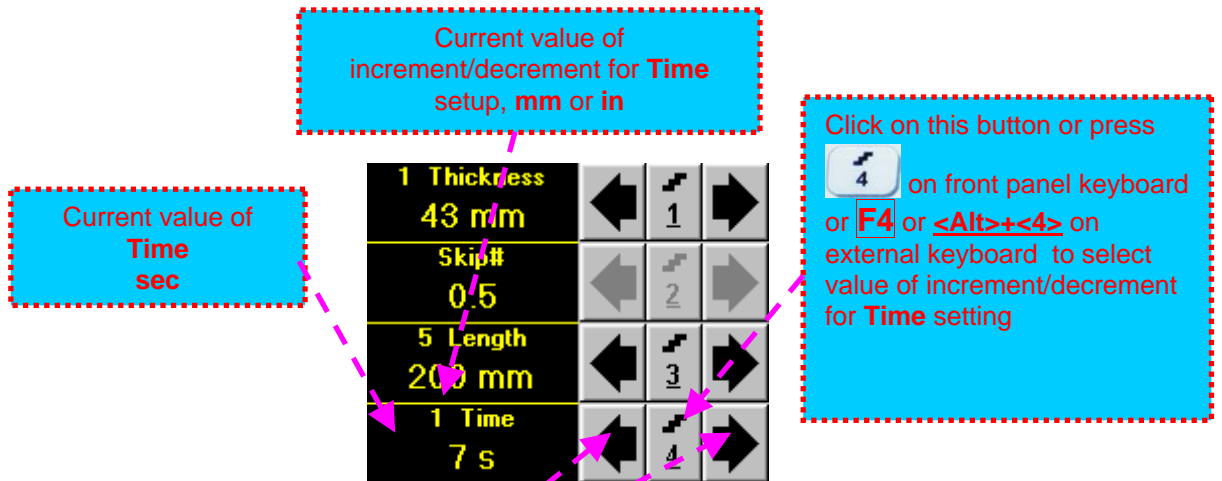

To control **Time** the following manipulations are applicable:

- **Mouse / Touch Screen**

- Click on corresponding **button**

- **Keyboard**

- Press on front panel keyboard or **F4** on external keyboard ⇒ **Time** fore color changes to white - then use , , , on front panel keyboard or , , , on external keyboard

- **Combined**

- Click on **Time** ⇒ **Time** fore color changes to white - then use , , , on front panel keyboard or , , , on external keyboard



The value of **Time** is adjustable between 5 and 60 **sec**

### Time-out

**Time-Out** is waiting time for intermissions predcessing **ABIScan** recording, which starts unconditionally upon **Time-Out** period is over. **Time-Out** has fixed duration of 3 sec for **t-ABIScan**

### Insert Text Note

Refer to paragraph 6.3.2.1 of this Operating Manual

### Preview UDS 3-5 Settings



Refer to paragraph 6.3.2.1 of this Operating Manual



### t-ABIScan Record Palette



There are four palettes available through click on appropriate button:





### Start/Stop t-ABIScan recording

Click on  or press  on front panel keyboard or **F8** or **<Alt>+<S>** on external keyboard to start **t-ABIScan** recording

 button becomes invisible since **t-ABIScan** recording starts.  button occupies its position.

Click on  or press  on front panel keyboard or **F8** or **<Alt>+<S>** on external keyboard to terminate **t-ABIScan** recording prior to automatic completion

 button becomes invisible after completion / termination of **t-ABIScan** record.  button returns to its position

### Save record into a file

Refer to paragraph 6.3.2.1 of this Operating Manual

### Open record from a file and starting postprocessing session

Refer to paragraph 6.3.2.1 of this Operating Manual

### Return to UDS 3-5 main operating surface

Refer to paragraph 6.3.2.1 of this Operating Manual

### 6.4.2.6. t-ABIScan – Scanning (Angle Beam Probes)

- Apply probe to test object in the start point of selected scanning line
- Click on **Start** or press **I** on front panel keyboard or **F8** or **<Alt>+<S>** on external keyboard
- Guide probe over the scanning line synchronously with *Probe Icon* moving with constant speed above **t-ABIScan** record field – typical scanning progress display during is shown and explained below

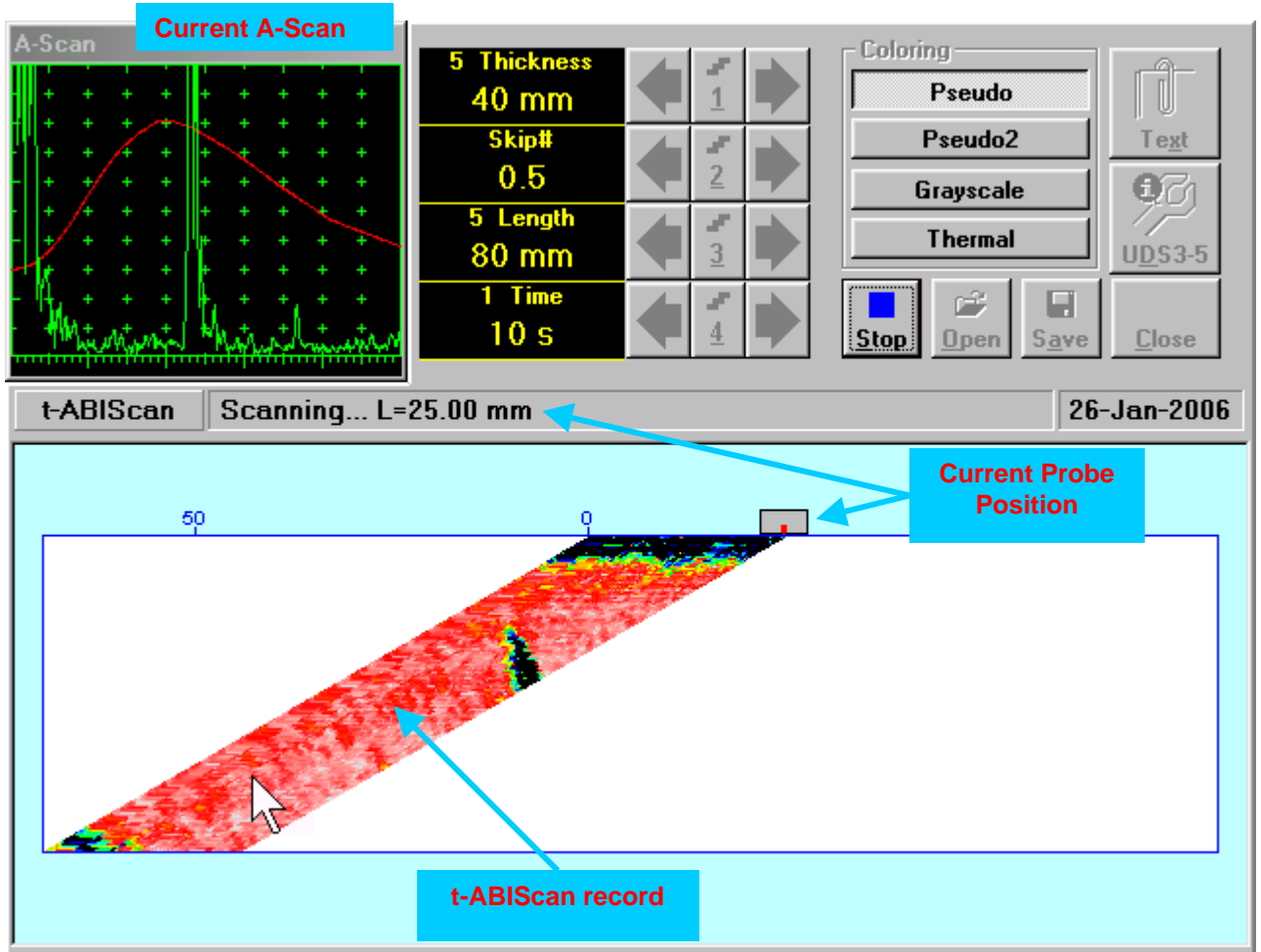

### 6.4.2.7. ABIScan – Prior to Scanning (Angle Beam Probes)

ABIScan control panel for angle beam probe is shown below

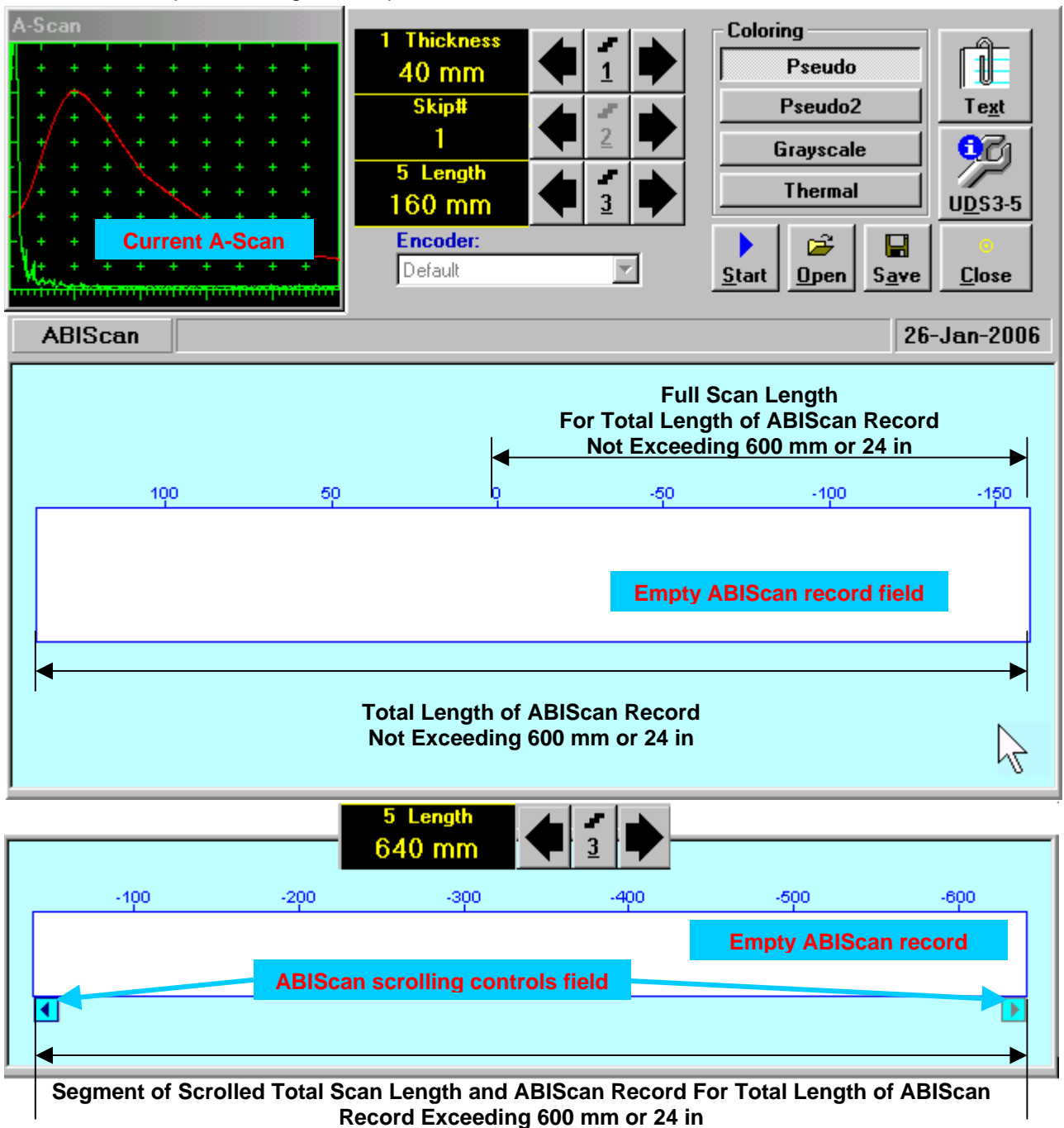

- **Display Delay** for current **A-Scan** to be used for the recording is equal to **Probe Delay** setting in submenu **MEASURE** of **UDS 3-5 Pulsar Receiver** preceeding entering into **ABIScan** mode
- **Total Length of ABIScan Record** is determined automatically according to:
  - Total Length of ABIScan Record = Total Scan Length + 2 \* Skip # \* Thickness \* Tan (Angle)**
  - where
    - ◆ **Thickness, Skip #, and Total Scan Length = Length** are the settings of **ABIScan** control panel
    - ◆ **Angle** is setting in submenu **MEASURE** of **UDS 3-5 Pulsar Receiver** preceeding entering into **ABIScan** mode

## Thickness and Skip #

**Thickness** and **Skip #** settings define the region of interest starting from the scanning surface and automatic **Range** setting for current **A-Scan** to be used for the recording:

$$\text{Range} = 2 \times \text{Skip \#} \times \text{Thickness} \times \text{Cos (Angle)}$$

whereas

- ◆ **Thickness** and **Skip #** are the settings of **ABIScan** control panel
- ◆ **Angle** is setting in submenu **MEASURE** of **UDS 3-5 Pulsar Receiver** precessing entering into **ABIScan** mode

For objects with parallel surfaces the actual **Thickness** value to be entered for full skip inspection (**Skip # = 1**)

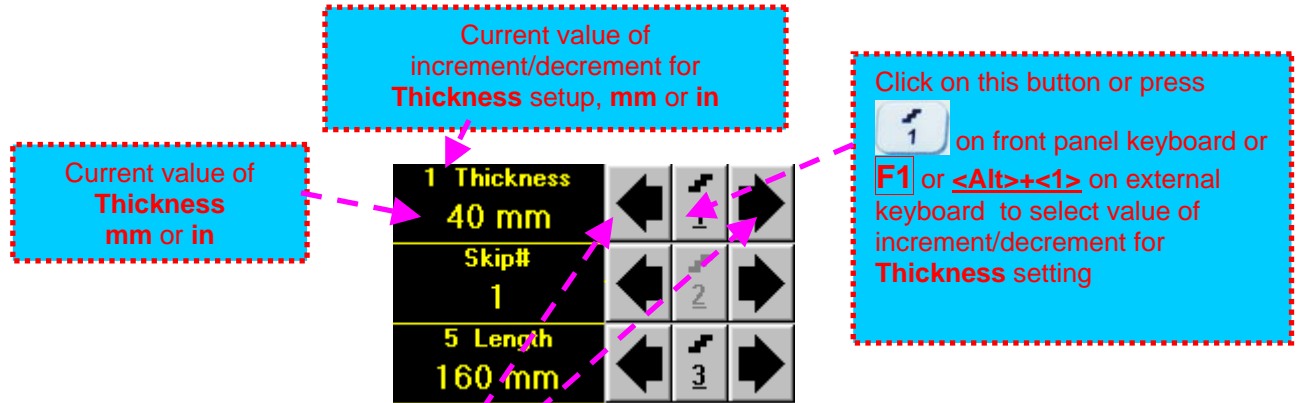







To control **Thickness** the following manipulations are applicable:









- **Mouse / Touch Screen**

- Click on corresponding button

- **Keyboard**

- Press  on front panel keyboard or **F1** on external keyboard ⇒ **Thickness** fore color changes to white - then use , , ,  on front panel keyboard or , , ,  on external keyboard

- **Combined**

- Click on **Thickness** ⇒ **Thickness** fore color changes to white - then use , , ,  on front panel keyboard or , , ,  on external keyboard



The value of **Thickness** is adjustable between 5 and 300 **mm** or 0.2 and 12 **in** (expandable on special inquire)

## Skip #

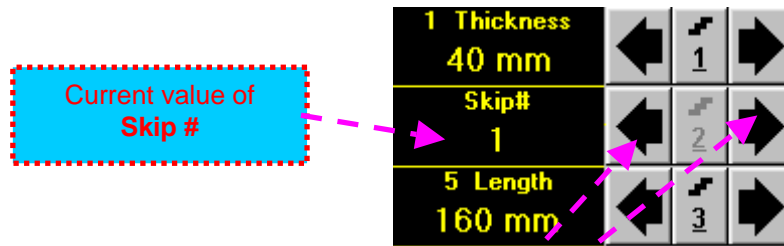

To control **Skip #** the following manipulations are applicable:









- **Mouse / Touch Screen**

- Click on corresponding **button**

- **Keyboard**

- Press  on front panel keyboard or **F2** on external keyboard ⇒ **Skip #** fore color changes to white - then use , , ,  on front panel keyboard or , , ,  on external keyboard

- **Combined**

- Click on **Skip #** ⇒ **Skip #** fore color changes to white - then use , , ,  on front panel keyboard or , , ,  on external keyboard



The **Skip #** setting may be **0.5** – half skip insonification or **1** – full skip insonification

## Scan Length

**Length** represents length of section of test object to be displayed, over which probe will be scanning during recording period

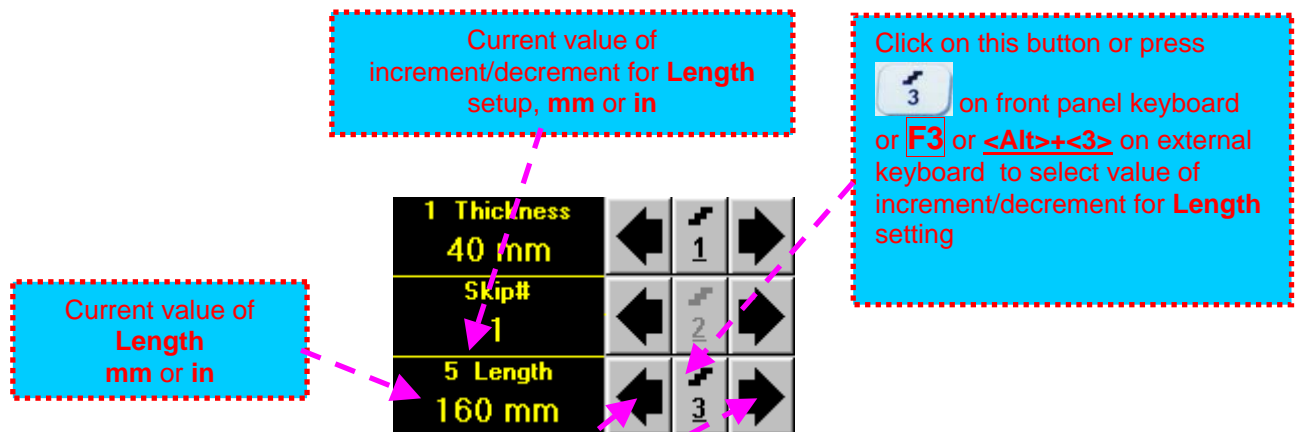

To control **Length** the following manipulations are applicable:

- **Mouse / Touch Screen**

- Click on corresponding **button**

- **Keyboard**

- Press on front panel keyboard or **F3** on external keyboard ⇒ **Length** fore color changes to white - then use , , , on front panel keyboard or , , , on external keyboard

- **Combined**

- Click on **Length** ⇒ **Length** fore color changes to white - then use , , , on front panel keyboard or , , , on external keyboard



The value of **Length** is adjustable between 50 and 1000 **mm** or 2 and 40 **in**

## Encoder

Select encoder to be used through appropriate box



Clamp probe into encoder – refer to Chapter 7 of this Operating Manual  
Connect encoder to its input on the rear panel of **ISONIC 2007** instrument

## Insert Text Note

Refer to paragraph 6.3.2.1 of this Operating Manual

## Preview UDS 3-5 Settings



Refer to paragraph 6.3.2.1 of this Operating Manual



## ABIScan Record Palette



There are four palettes available through click on appropriate button:





## Start/Stop t-ABIScan recording

Click on  or press  on front panel keyboard or **F8** or **<Alt>+<S>** on external keyboard to start **ABIScan** recording

 button becomes invisible since **ABIScan** recording starts.  button occupies its position.

Click on  or press  on front panel keyboard or **F8** or **<Alt>+<S>** on external keyboard to terminate **ABIScan** recording prior to automatic completion

 button becomes invisible after termination of **ABIScan** record.  button returns to its position

## Save record into a file

Refer to paragraph 6.3.2.1 of this Operating Manual

## Open record from a file and starting postprocessing session

Refer to paragraph 6.3.2.1 of this Operating Manual

## Return to UDS 3-5 main operating surface

Refer to paragraph 6.3.2.1 of this Operating Manual



### 6.4.2.8. ABIScan – Scanning (Angle Beam Probes)

- Apply probe equipped with an encoder to test object in the start point of selected scanning line

- Click on **Start** or press **I** on front panel keyboard or **F8** or **<Alt>+<S>** on external keyboard
- Guide probe over the scanning line – typical scanning progress display during is shown and explained below

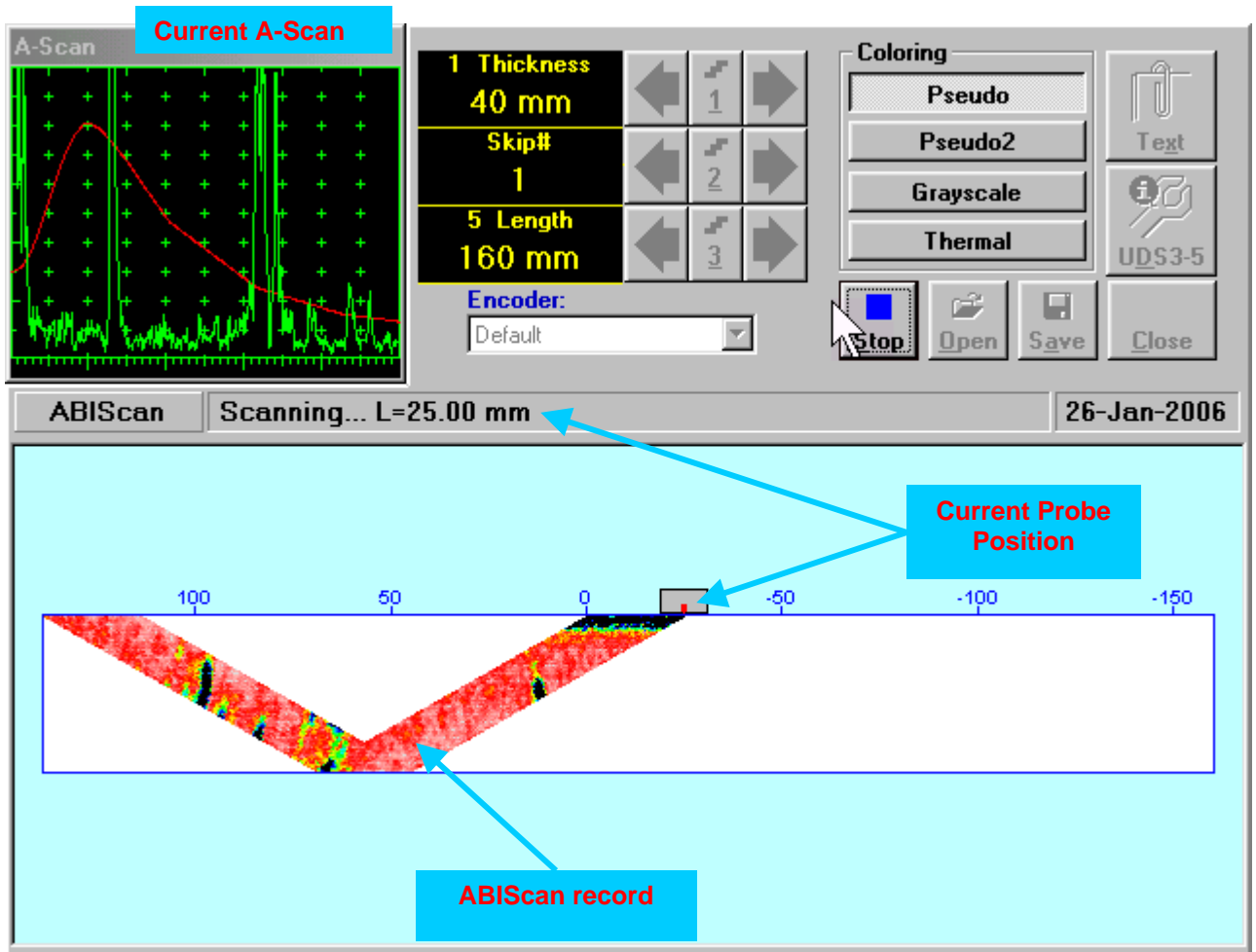

### 6.4.2.9. t-ABIScan / ABIScan – Postprocessing

Versatile postprocessing of **t-ABIScan / ABIScan** records is featured with:

- ❑ Sizing defects at any location along stored images (coordinates, projection size, amplitude-based evaluation)
- ❑ Play-back and evaluation of **A-Scans** obtained and captured during **t-ABIScan / ABIScan** defects imaging and recording
- ❑ Defects outlining and pattern recognition based on **A-Scan** sequence analysis – **Echo Dynamic Pattern Analysis**
- ❑ Reconstruction of **B-Scan** defects images for various **Gain, Reject,** and **off-line Gate** level settings
- ❑ **DAC / DGS t-ABIScan / ABIScan** normalization





The screen as below appears upon opening file. All postprocessing procedures are performed through **menu bar** – touch screen stylus or front panel or external mouse to be used



#### Menu Bar Functions

- **File→Open** – opens new **t-ABIScan / ABIScan** file
- **File→Snapshots→Add Snapshot** – stores current postprocessing screen snapshot accompanied with appropriate settings and measurements into *postprocessing session memory stack*
- **File→Snapshots→Restore Snapshot** – recalls earlier stored postprocessing screen snapshot accompanied with appropriate settings and measurements from *postprocessing session memory stack*
- **File→Snapshots→Delete Snapshot** – deletes earlier stored postprocessing screen snapshot accompanied with appropriate settings and measurements from *postprocessing session memory stack*
- **File→Print** – prints out postprocessing screen snapshot(s) accompanied with appropriate settings and measurements
- **File→Exit** – returns to **t-ABIScan / ABIScan** control panel
- **View→Instrument** – indicates setup of **UDS 3-5** Pulser Receiver used for scanning when file was created
- **View→Inspection Data** – indicates operator's comments entered prior to scanning
- **View→Coloring** – selects palette for **t-ABIScan / ABIScan** image

- **A-Scan Recovery →ON** (*straight beam inspection record*) – generates *cursor representing sound path* of straight beam probe's central beam in the object under test that may be guided over **t-ABIScan** /

**ABIScan** image using either touch screen stylus or mouse or  ,  on front panel keyboard or  ,  on external keyboard – corresponding **A-Scan** is recovered synchronously according to *sound path cursor* position. Starting position of cursor (**L**) corresponding to probe's center is indicated in the **A-Scan Recovery** field. On the recovered **A-Scan** there is red **Off-line Gate** presented. Initially **Off-line Gate** covers whole **A-Scan** range

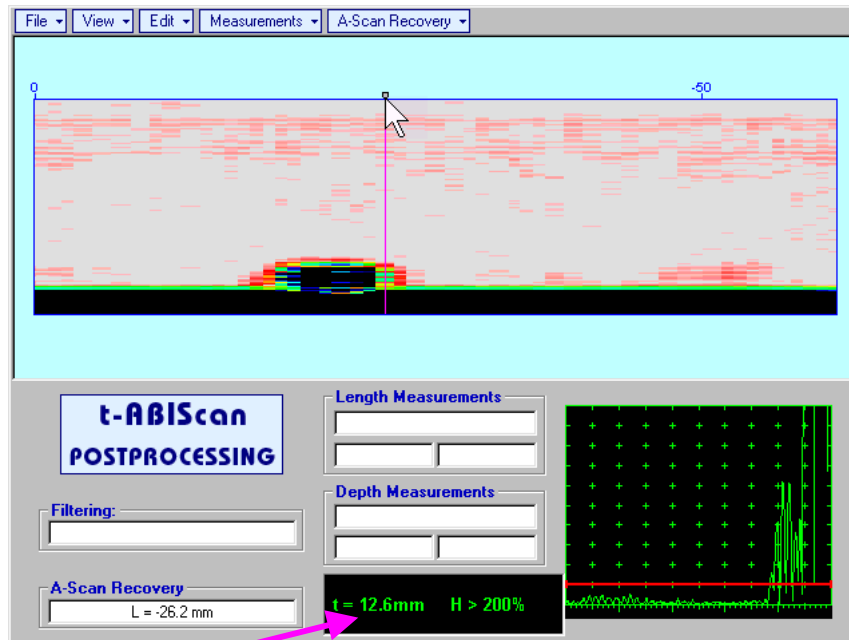

**Automatic Measurements Display** accompanies recovered **A-Scan** and indicates (refer to paragraphs 5.1.12, 5.2.13.1 and 5.2.13.2 of this Operating Manual):





- depth **t** of reflector (measurement mode - **Flank**)
- amplitude **H** of the maximal signal in the **Off-line Gate** expressed in % of full **A-Scan** height
- **ΔVC (dB to DAC)** of the maximal signal in the **Off-line Gate** provided that DAC was active whilst recording **t-ABIScan** / **ABIScan** data

To fix position of *sound path cursor* with corresponding recovered **A-Scan** and **Automatic**

**Measurements Display** data left mouse click or release touch screen stylus or press  on front panel keyboard or **Enter** on external keyboard

To interrupt recovery of **A-Scans** and empty **A-Scan Recovery** field right mouse click or press  on front panel keyboard or **Esc** on external keyboard

- **A-Scan Recovery →OFF** (*straight beam inspection record*) – erases *sound path cursor* with recovered **A-Scan** and **Automatic Measurements Display** and empties **A-Scan Recovery** field

- **A-Scan Recovery →ON** (*angle beam inspection record*) – generates *cursor representing sound path* of angle beam probe's central beam in the object under test that may be guided over **t-ABIScan / ABIScan** image using either touch screen stylus or mouse or ,  on front panel keyboard or ,  on external keyboard – corresponding **A-Scan** is recovered synchronously according to *sound path cursor* position. Starting position of cursor (**L**) corresponding to probe's incidence point is indicated in the **A-Scan Recovery** field. On the recovered **A-Scan** there is red **Off-line Gate** presented. Initially **Off-line Gate** covers whole **A-Scan** range

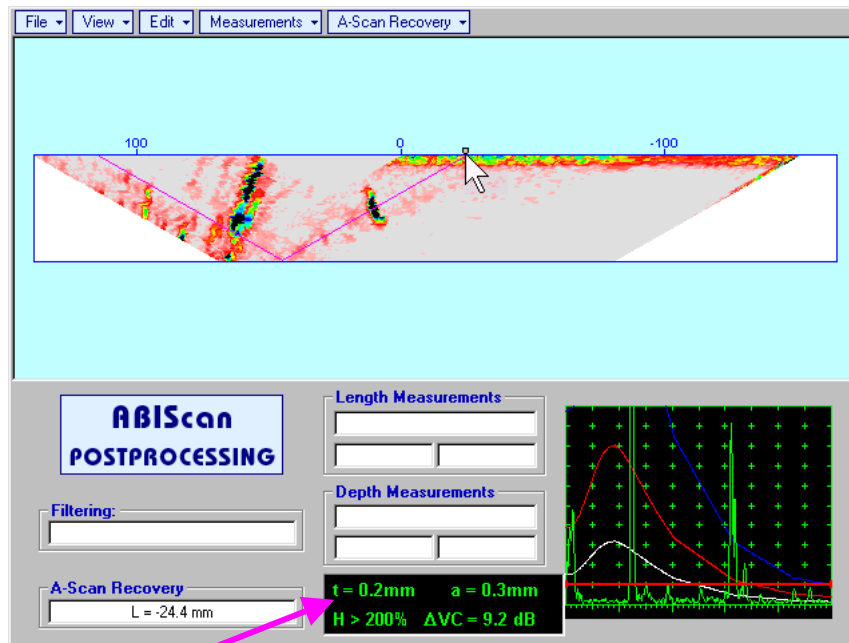

**Automatic Measurements Display** accompanies recovered **A-Scan** and indicates (refer to paragraphs 5.1.12, 5.2.13.1 and 5.2.13.2 of this Operating Manual):











- depth **t** of reflector (measurement mode - **Flank**)
- distance **a** between probe incidence point and reflector taken along scanning surface (measurement mode - **Flank**)
- amplitude **H** of the maximal signal in the **Off-line Gate** expressed in % of full **A-Scan** height
- **ΔVC (dB to DAC)** of the maximal signal in the **Off-line Gate** provided that DAC was active whilst recording **t-ABIScan / ABIScan** data

To fix position of *sound path cursor* with corresponding recovered **A-Scan** and **Automatic**





**Measurements Display** data left mouse click or release touch screen stylus or press  on front panel keyboard or **Enter** on external keyboard

To interrupt recovery of **A-Scans** and empty **A-Scan Recovery** field right mouse click or press  on front panel keyboard or **Esc** on external keyboard

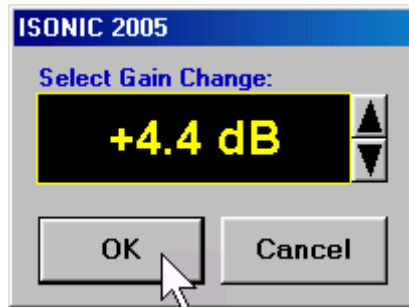
- **A-Scan Recovery →OFF** (*angle beam inspection record*) – erases *sound path cursor* with recovered **A-Scan** and **Automatic Measurements Display** and empties **A-Scan Recovery** field

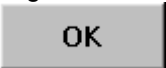

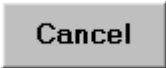

- Edit→Change Gain→ON** – (*straight beam and angle beam inspection records*) generates *cursor representing sound path* of probe's central beam in the object under test that may be guided over **t-ABIScan** / **ABIScan** image using either touch screen stylus or mouse or  ,  on front panel keyboard or  ,  on external keyboard – corresponding **A-Scan** is recovered synchronously according to *sound path cursor* position. To select reference **A-Scan** release touch screen stylus or left mouse click or press  on front panel keyboard or **Enter** on external keyboard – this generates subwindow allowing off-line re-adjusting of **Gain** for all **A-Scans** captured during **t-ABIScan** / **ABIScan** recording in **±6dB** range with **±0.1 dB** increments through clicking or pressing and holding on  or pressing  ,  on front panel keyboard or  ,  on external keyboard









- During **Gain** re-adjusting reference **A-Scan** is modified accordingly. Upon completing re-adjusting **Gain** click on  or press  on front panel keyboard or **Enter** on external keyboard – this applies new **Gain** value to all captured **A-Scans** and redraws **t-ABIScan** / **ABIScan** image accordingly
- To interrupt re-adjusting of **Gain** click on  or press  on front panel keyboard or **Esc** on external keyboard

- Edit→Change Gain→OFF** – negates **Gain** re-adjustment and returns to originally recorded **t-ABIScan** / **ABIScan** image and original **Gain** setting

- **Edit→ROI→ON** (*straight beam inspection record*) – generates *cursor* representing *sound path* of straight beam probe's central beam in the object under test that may be guided over **t-ABIScan** /

**ABIScan** image using either touch screen stylus or mouse or  ,  on front panel keyboard or  ,  on external keyboard – corresponding **A-Scan** is recovered synchronously according to *sound path cursor* position. To select reference **A-Scan** release touch screen stylus or left mouse click or press

 on front panel keyboard or **Enter** on external keyboard – this generates **Off-line Gate** controls

 ,  ,  ,  ,  ,  allowing to redefine **Region Of Interest** for **t-ABIScan** / **ABIScan** imaging

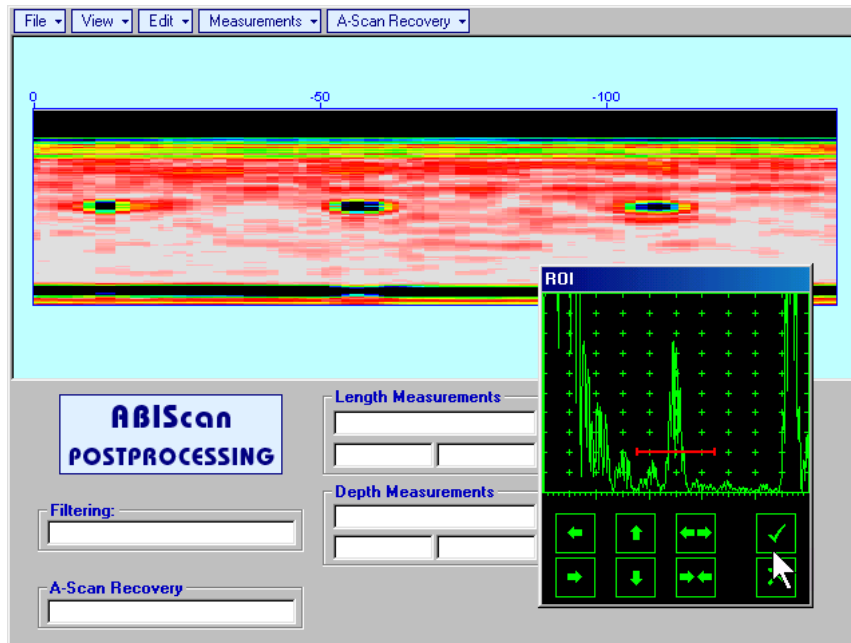

To interrupt selection of reference of **A-Scan** right mouse click or press  on front panel keyboard or **Esc** on external keyboard

To interrupt re-adjustment of **Region Of Interest** after selection of reference of **A-Scan** click on 



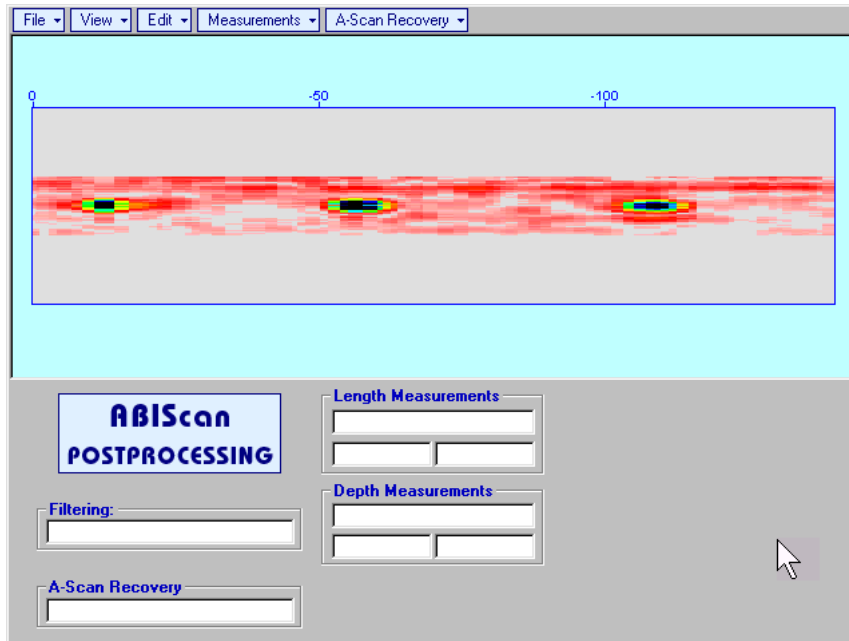



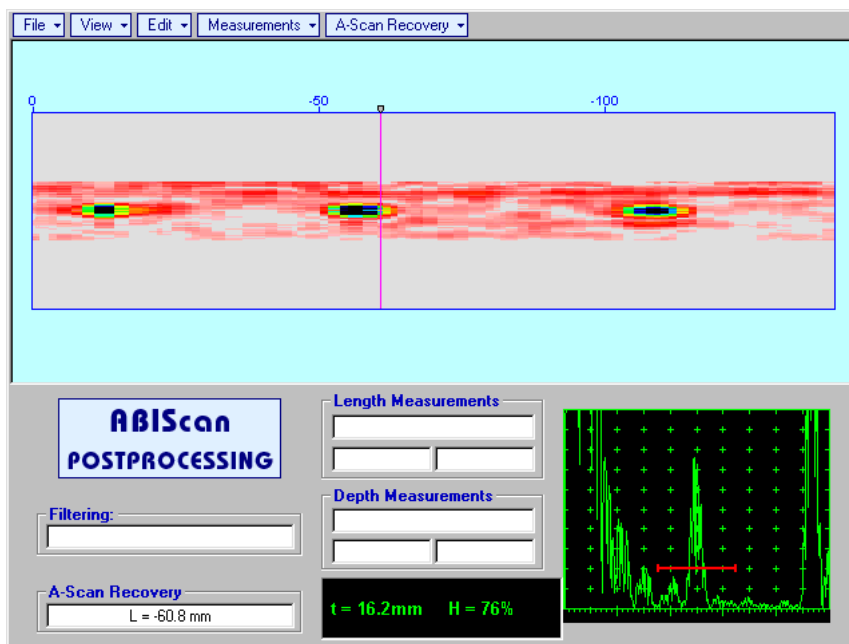



Upon completing redefining of **Region Of Interest** click on  – this applies new **Off-line Gate** to all captured **A-Scans** and updates **t-ABIScan / ABIScan** image accordingly – only segment of **t-ABIScan / ABIScan** image covered by newly adjusted **Off-line Gate** remains visible





It is possible then to perform **A-Scan** signals evaluation using newly adjusted **Off-Line Gate** through **A-Scan Recovery** → **ON**

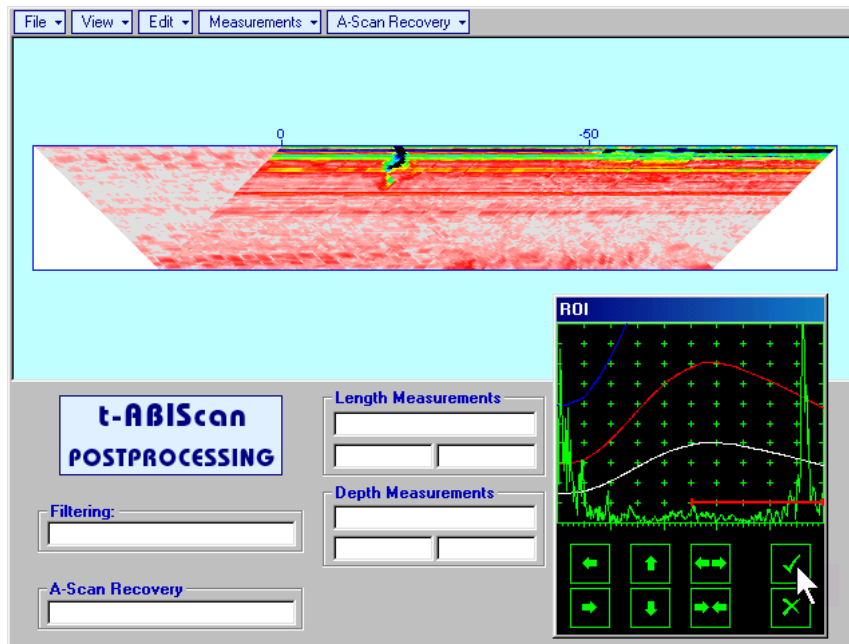

- **Edit→ROI→OFF** (*straight beam inspection record*) – negates **Off-line Gate** re-adjustment and returns to originally recorded **t-ABIScan / ABIScan** image and initial **Off-line Gate** setting

- Edit→ROI→ON** (*angle beam inspection record*) – generates *cursor representing sound path* of angle beam probe's central beam in the object under test that may be guided over **t-ABIScan / ABIScan** image using either touch screen stylus or mouse or ,  on front panel keyboard or ,  on external keyboard – corresponding **A-Scan** is recovered synchronously according to *sound path cursor* position. To select reference **A-Scan** release touch screen stylus or left mouse click or press  on front panel keyboard or **Enter** on external keyboard – this generates **Off-line Gate** controls , , , , ,  allowing to redefine **Region Of Interest** for **t-ABIScan / ABIScan** imaging



To interrupt selection of reference of **A-Scan** right mouse click or press  on front panel keyboard or **Esc** on external keyboard

To interrupt re-adjustment of **Region Of Interest** after selection of reference of **A-Scan** click on 





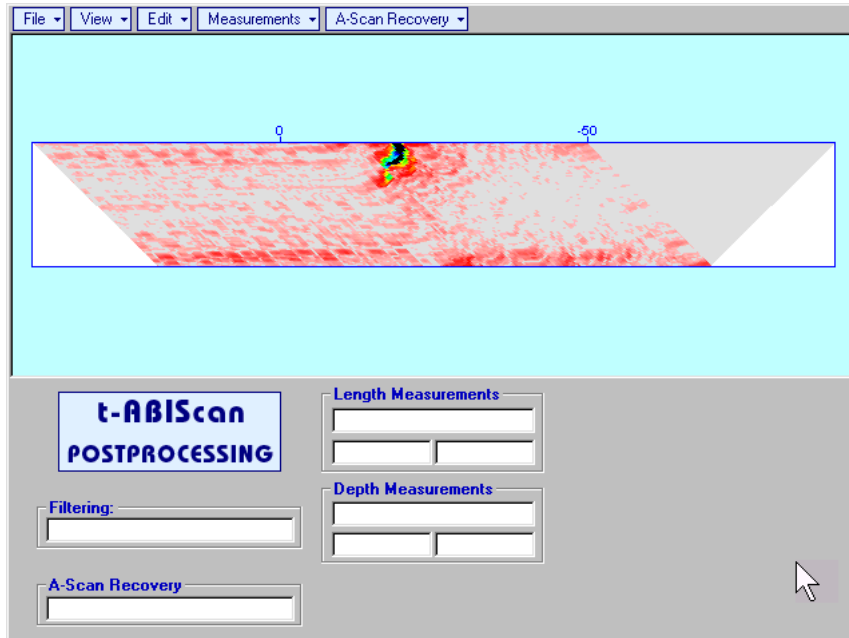

Upon completing redefining of **Region Of Interest** click on  – this applies new **Off-line Gate** to all **A-Scans** captured during **t-ABIScan / ABIScan** recording and updates **t-ABIScan / ABIScan** image accordingly – only segment of **t-ABIScan / ABIScan** image covered by newly adjusted **Off-line Gate** remains visible: in the present example there was under surface crack detected using full skip insonification and **Off-line Gate** was readjusted by such a way that only full skip segment of **t-ABIScan / ABIScan** image remained visible – this allowed to eliminate disturbing presence of initial pulse reverberations on the **t-ABIScan / ABIScan** image

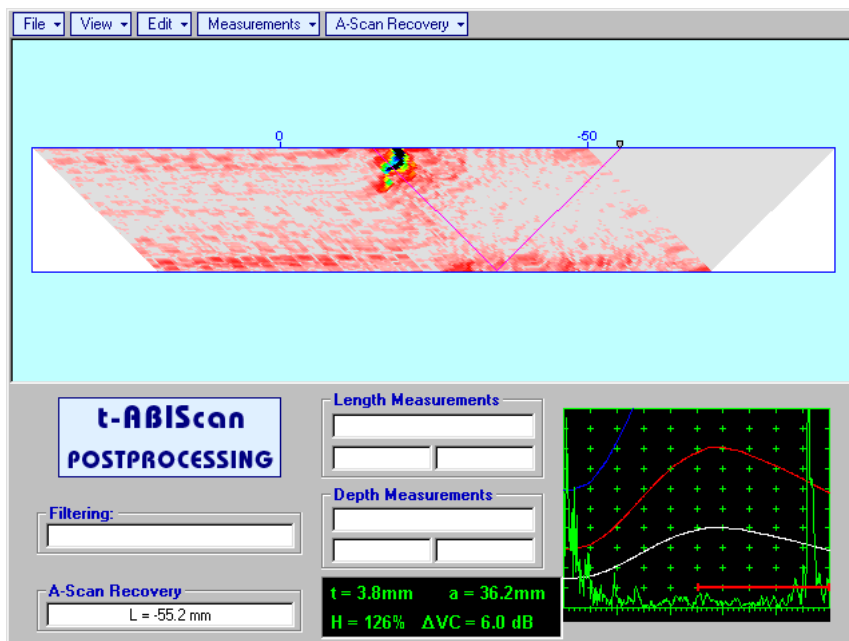

It is possible then to perform **A-Scan** signals evaluation using newly adjusted **Off-Line Gate** through **A-Scan Recovery** → **ON**



- **Edit**→**ROI**→**OFF** (*angle beam inspection record*) – negates **Off-line Gate** re-adjustment and returns to originally recorded **t-ABIScan / ABIScan** image and initial **Off-line Gate** setting

- **Edit→Filtering→ON** – (*straight beam and angle beam inspection records*) generates *amplitude palette bar* with *sliding cursor*, which may be controlled using either touch screen stylus or mouse or ,  on front panel keyboard or ,  on external keyboard . Position of the *sliding cursor* on the *amplitude palette bar* determines filtering level, which is indicated in the **Filtering** field. All elements of **t-ABIScan / ABIScan** image representing signal amplitude below filtering level are suppressed:

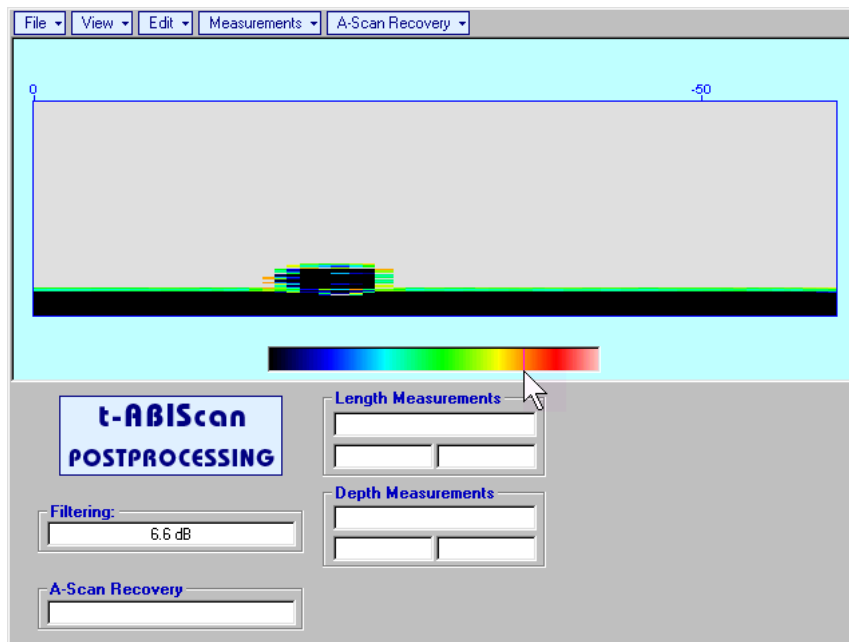

- **Edit→Filtering→OFF** (*straight beam and angle beam inspection records*) – returns to originally recorded **t-ABIScan / ABIScan** image and empties **Filtering** field



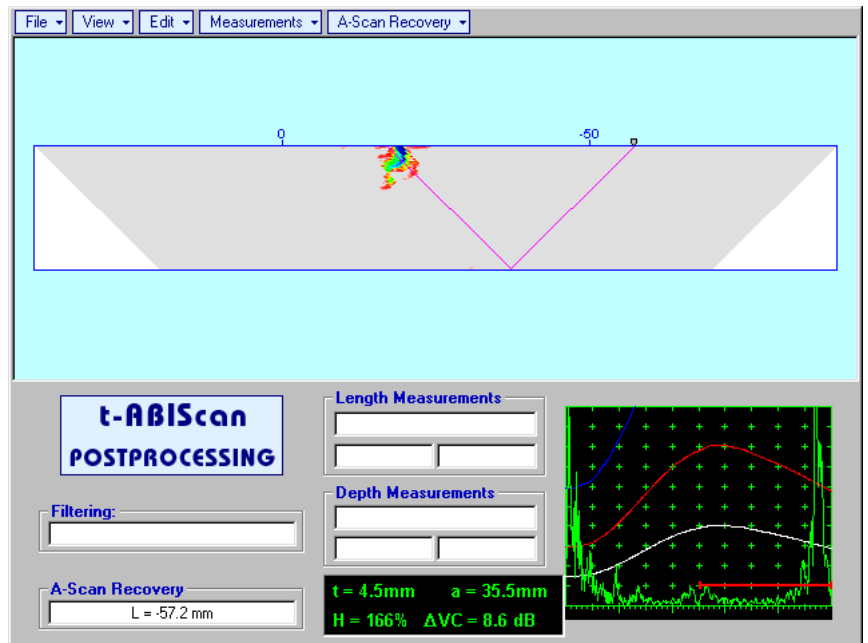
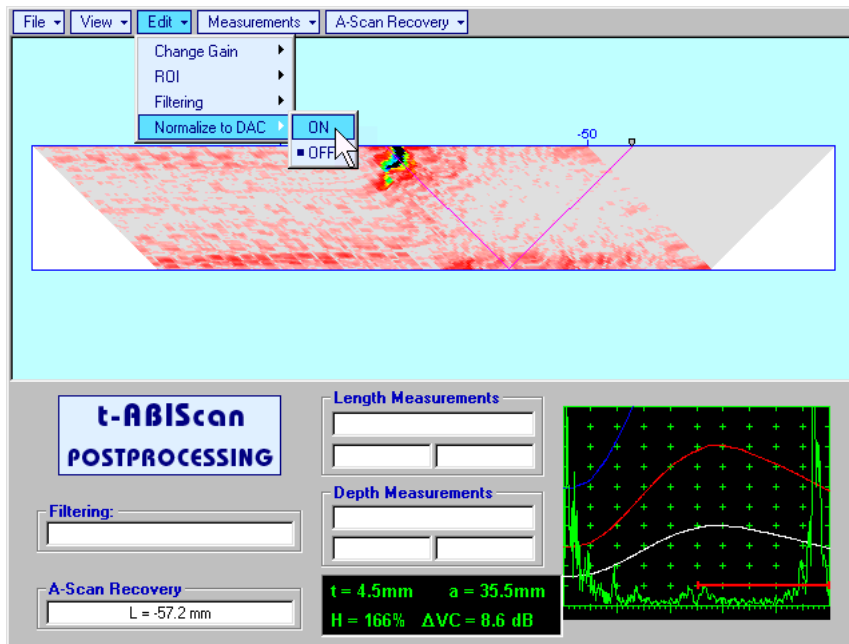









- **Edit→Normalize to DAC→ON** (*straight beam and angle beam inspection records*) – applies **DAC/DGS** normalized color palette to **t-ABIScan / ABIScan** image, which was recorded with active **DAC/DGS** and redraws **t-ABIScan / ABIScan** image correspondingly (**dB to DAC/DGS** normalization)



- **Edit→Normalize to DAC→OFF** (*straight beam and angle beam inspection records*) – negates **dB to DAC/DGS** normalization and returns to originally recorded **t-ABIScan / ABIScan** image



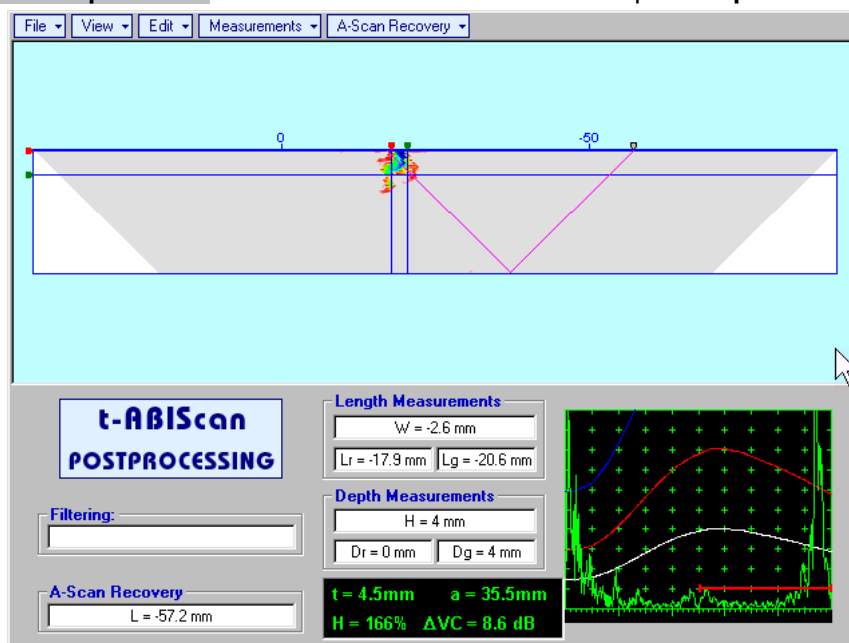

Applying of **Edit→Normalize to DAC→ON** or **Edit→Normalize to DAC→OFF** negates **Filtering** (**Edit→Filtering→OFF**)

- Measurements→Length→ON** – generates first vertical cursor that may be guided over **t-ABIScan / ABIScan** image using either touch screen stylus or mouse or ,  on front panel keyboard or ,  on external keyboard . Coordinate of the first vertical cursor along **t-ABIScan / ABIScan** image (**Lr**) is indicated in the **Length Measurements** field. To fix position of the first vertical cursor left mouse click or release touch screen stylus or press  on front panel keyboard or **Enter** on external keyboard . To interrupt vertical cursor manipulations and empty **Length Measurements** field right mouse click or press  on front panel keyboard or **Esc** on external keyboard  
 Second vertical cursor appears upon fixing first one, it may be manipulated by the same way. Coordinate of the second vertical cursor along **t-ABIScan / ABIScan** image (**Lg**) is indicated in the **Length Measurements** field along with parameter **W = Lg – Lr**. Parameter **W** represents projection length of defect provided that vertical cursors are placed appropriately
- Measurements→Length→OFF** – erases vertical cursors and empties **Length Measurements** field
- Measurements→Depth→ON** – generates first horizontal cursor that may be guided over **t-ABIScan / ABIScan** image using either touch screen or mouse or ,  on front panel keyboard or ,  on external keyboard . Coordinate of the first horizontal cursor along **t-ABIScan / ABIScan** image (**Dr**) is indicated in the **Depth Measurements** field. To fix position of the first horizontal cursor left mouse click or release touch screen stylus or press  on front panel keyboard or **Enter** on external keyboard . To interrupt horizontal cursor manipulations and empty **Depth Measurements** field right mouse click or press  on front panel keyboard or **Esc** on external keyboard  
 Second horizontal cursor appears upon fixing first one, it may be manipulated by the same way. Coordinate of the second horizontal cursor along **t-ABIScan / ABIScan** image (**Dg**) is indicated in the **Depth Measurements** field along with parameter **H = Dg – Dr**. Parameter **H** represents thickness loss provided that horizontal cursors are placed appropriately
- Measurements→Depth→OFF** – erases horizontal cursors and empties **Depth Measurements** field



## 6.5. TOFD Inspection – RF B-Scan and D-Scan Imaging and Recording – t-TOFD or TOFD

### 6.5.1. Setup Pulser Receiver for t-TOFD and TOFD

UDS 3-5 Pulser Receiver window – main operating surface – appears on ISONIC 2007 screen upon clicking on  or . The following settings to be provided:

| # | Parameter or Mode  | Submenu  | Required Settings   | Note   |
|---|--|----------|---|--|
| 1 | Pulser Mode  | PULSER   | Dual  |  |
| 2 | Tuning, Pulse Width, Firing Level, Damping                   | PULSER   | Tuning, Pulse Width, Firing Level, and Damping settings to provide optimal signal to noise ratio  | To synchronize with Gain setting procedure   |
| 3 | Filter, Frequency  | RECEIVER | Filter and Frequency settings to match with probe's frequency   | To synchronize with Gain setting procedure   |
| 4 | Display  | RECEIVER | RF  |  |
| 5 | USVelocity   | BASIC    | USVelocity setting to be equal to actual value of ultrasound velocity in the object under test  |  |
| 6 | Probe Delay  | MEASURE  | Probe Delay setting to be equal to actual <b>Accumulated Probe Pair Delay</b>   | Accumulated Probe Pair Delay may be determined according to paragraph 6.5.1.1 of this Operating Manual |
| 7 | Display Delay Range  | BASICS   | Display Delay and Range to provide clear <b>A-Scan</b> representing: <ul style="list-style-type: none"> <li>o Lateral Wave and Longitudinal Wave Back Echo Signals at the beginning and at the end of <b>A-Scan</b> correspondingly</li> <li style="text-align: center;">OR</li> <li>o Lateral Wave, Longitudinal Wave Back Echo, and Mode Conversion Back Echo at the beginning, middle, and at the end of <b>A-Scan</b> correspondingly</li> <li style="text-align: center;">OR</li> <li>o Other combination of signals required by Inspection procedure</li> </ul> | Display Delay and Range will be determined according to paragraph 6.5.1.2 of this Operating Manual     |
| 8 | Gain   | BASICS   | Gain setting to be performed according to inspection procedure providing required amplitude of signals from defects to be detected  | Refer to paragraph 6.5.1.3 of this Operating Manual  |
| 9 | Settings for other parameters and modes have no significance |          |   |  |

Click on  or press  on front panel keyboard or **F8** on external keyboard upon completing

### 6.5.1.1. Accumulated Probe Pair Delay

Two probes to be used in order to capture the *TOFD Map*. The **Probe Delay** to be precisely measured for each of them.

#### Measuring Probe Delay - Miniature Probes (contact face width 12.5 mm / 0.5 in or less) – Pulse Echo Technique

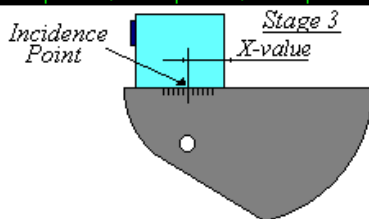
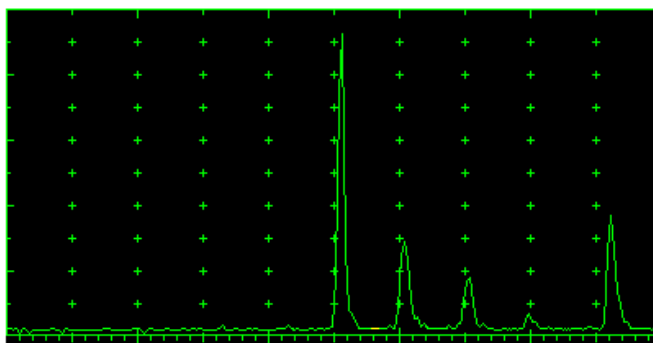
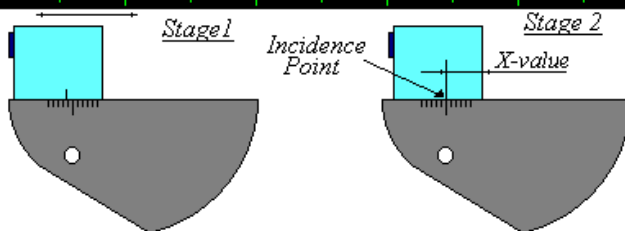
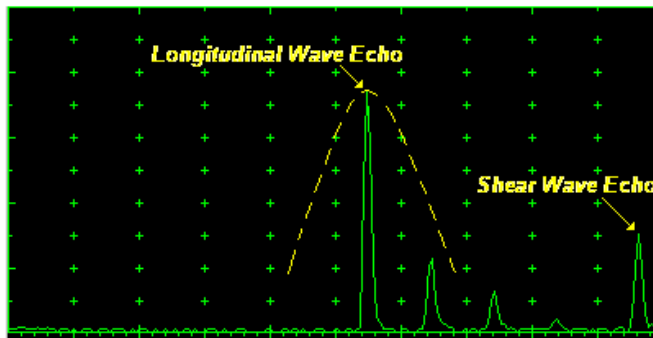

Activate submenu **PULSER** then set:

- Pulser Mode** to **Single**
- Pulse Width** to **Spike (240 μJ)** for probe having resonant frequency of 8 MHz and higher or to **PW ns**, were  $PW = 0.5 / F$  (F is the probe resonant frequency) for probes having resonant frequency below 8 MHz
- Firing Level** to **18**
- Damping** to **1000 Ω**
- Tuning** to **NO**

Activate submenu **RECEIVER** then set:

- Display** to **Full** or **RF**
- Filter** to **BB**
- Frequency** to completely cover probe's effective bandwidth

Activate submenu **BASICS** topic then set:

- US Velocity** to **5920 m/s (233.1 in/ms)**
- Range** to **50.0 mm (2 in)**
- Display Delay** to **0 μs**
- Reject** to **0%**

**Stage 1:** Manipulate probe over main working surface of V-2 reference standard and maximize echo from 25 mm (1 in) radius concave reflector

**Stage 2:** Fix probe in found position - the center of 25 mm (1 in) radius concave reflector will indicate **incident point** while the distance between probe's frontal edge and **incident point** is equal to **X-Value**

**Stage 3:** Tune **Display Delay** while probe is still fixed in found position until rising edge of maximized echo will match with 50%-grid of the **A-Scan** width. Upon completing the *obtained value of Display Delay* will be equal to *actual Probe Delay*



- ◆ It's necessary to setup **Gain** bringing height of maximized echo to **75-80%** of **A-Scan** height
- ◆ It is recommended to optimize **Tuning** in **PULSER** submenu upon obtaining maximized echo. The goal of such optimization is increasing of ultrasonic excitation energy through better matching between firing output and probe. Level of ultrasonic excitation energy is clearly represented by echo amplitude. Upon completing **Tuning** optimization **Gain** to be adjusted to bring echo to **75-80%** of **A-Scan** height

Supposing that **Probe Delay** values found for probes of the pair are  $PD_1$  and  $PD_2$   
**Accumulated Probe Pair Delay =  $0.5 \cdot (PD_1 + PD_2)$**

**Measuring Probe Delay - Large and Medium Size Probes (contact face width more than 12.5 mm / 0.5 in) – Pulse Echo Technique**

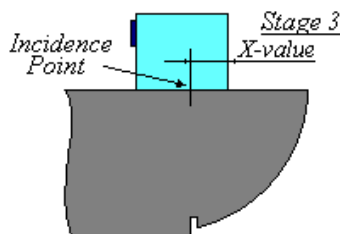
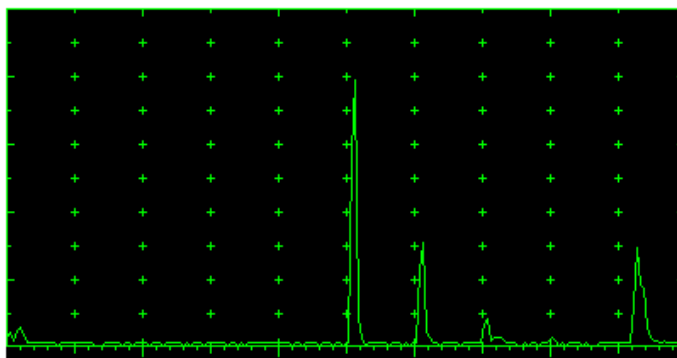
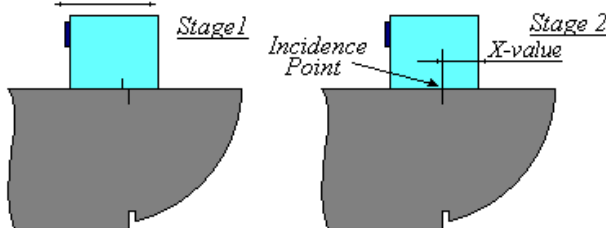
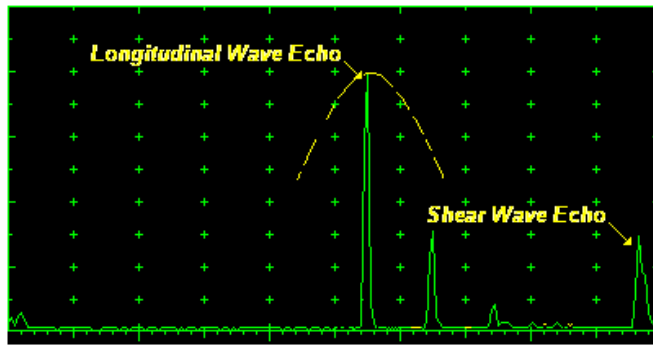

Activate submenu **PULSER** then set:

- Pulser Mode**
- Pulse Width** to **Spike (240 μJ)** for probe having resonant frequency of 8 MHz and higher or to **PW ns**, were **PW = 0.5 / F** (F is the probe resonant frequency) for probes having resonant frequency below 8 MHz
- Firing Level** to **18**
- Damping** to **1000 Ω**
- Tuning** to **NO**

Activate submenu **RECEIVER** then set:

- Display** to **Full** or **RF**
- Filter** to **BB**
- Frequency** to completely cover probe's effective bandwidth

Activate submenu **BASICS** topic then set:

- US Velocity** to **5920 m/s (233.1 in/ms)**
- Range** to **200.0 mm (8 in)**
- Display Delay** to **0 μs**
- Reject** to **0%**

**Stage 1:** Manipulate probe over main working surface of V-1 reference standard and maximize echo from 100 mm (4 in) radius concave reflector

**Stage 2:** Fix probe in found position - the center of 100 mm (4 in) radius concave reflector will indicate **incident point** while the distance between probe's frontal edge and **incident point** is equal to **X-Value**

**Stage 3:** Tune **Display Delay** while probe is still fixed in found position until rising edge of maximized echo will match with 50%-grid of the **A-Scan** width. Upon completing the *obtained value of Display Delay will be equal to actual Probe Delay*



- ◆ It's necessary to setup **Gain** bringing height of maximized echo to **75-80%** of **A-Scan** height
- ◆ It is recommended to optimize **Tuning** in **PULSER** submenu upon obtaining maximized echo. The goal of such optimization is increasing of ultrasonic excitation energy through better matching between firing output and probe. Level of ultrasonic excitation energy is clearly represented by echo amplitude. Upon completing **Tuning** optimization **Gain** to be adjusted to bring echo to **75-80%** of **A-Scan** height

Supposing that **Probe Delay** values found for probes of the pair are **PD<sub>1</sub>** and **PD<sub>2</sub>**  
**Accumulated Probe Pair Delay = 0.5•(PD<sub>1</sub> + PD<sub>2</sub>)**

**Direct Measurement of Accumulated Probe Pair Delay - All Sizes of Probes – Through Transmission Technique**

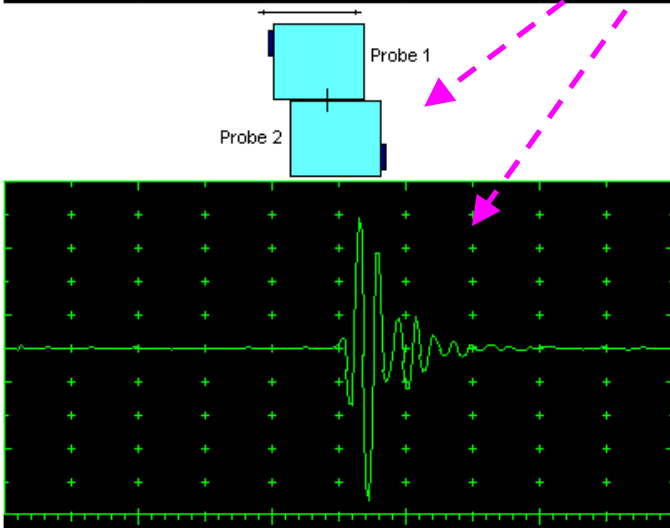
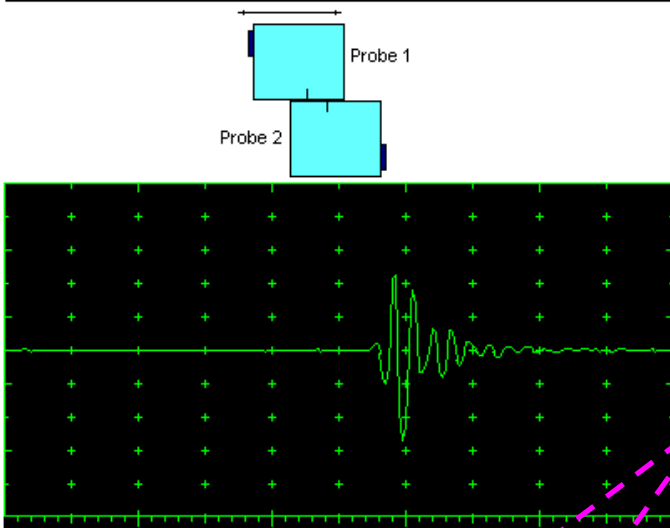
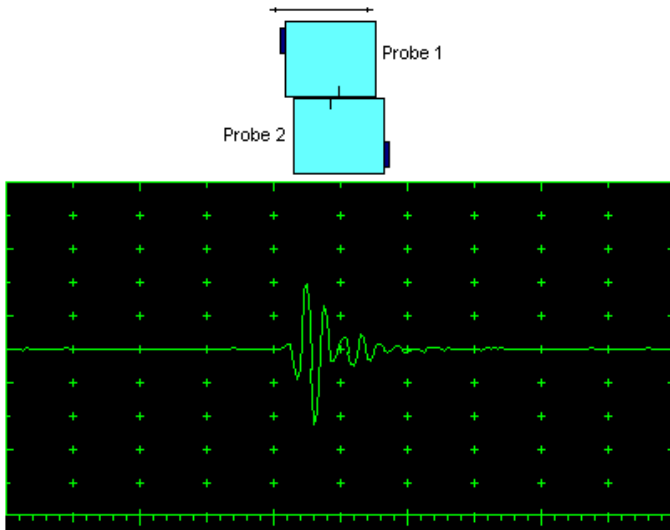

Activate submenu **PULSER** then set:

- Pulser Mode** to **Dual**
- Pulse Width** to **Spike (240 μJ)** for probe having resonant frequency of 8 MHz and higher or to **PW ns**, were  $PW = 0.5 / F$  (F is the probe resonant frequency) for probes having resonant frequency below 8 MHz
- Firing Level** to **18**
- Damping** to **1000 Ω**
- Tuning** to **NO**

Activate submenu **RECEIVER** then set:

- Display** to **RF**
- Filter** to **BB**
- Frequency** to completely cover probe's effective bandwidth

Activate submenu **BASICS** topic then set:

- Display Delay** to **0 μs**

**Stage 1:** Manipulate probes over each other and setup of **Gain**, **Range**, and **USVelocity** providing firm indication of the signal propagating in the probes wedges from emitting to receiving crystal then maximize said signal

**Stage 2:** Fix the probe in the found position corresponding to highest signal amplitude

**i**

- ◆ It's necessary to setup **Gain** bringing height of maximized echo to **75-80%** of **A-Scan** height
- ◆ It is recommended to optimize **Tuning** in **PULSER** submenu upon obtaining maximized echo. The goal of such optimization is increasing of ultrasonic excitation energy through better matching between firing output and probe. Level of ultrasonic excitation energy is clearly represented by echo amplitude. Upon completing **Tuning** optimization **Gain** to be adjusted to bring echo to **75-80%** of **A-Scan** height



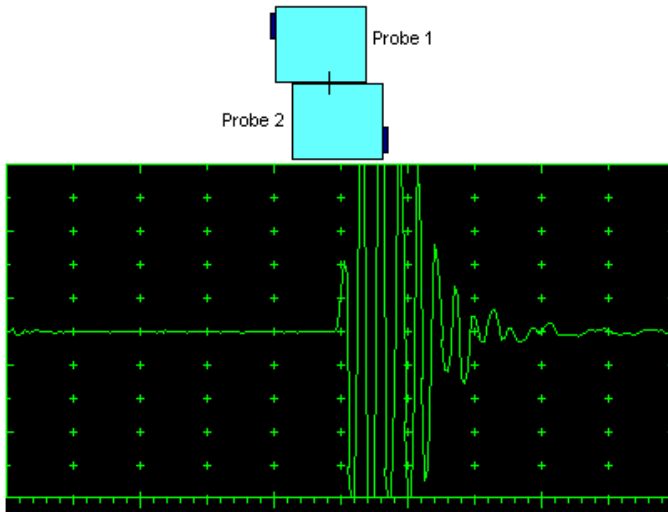

**Stage 3:** Increase Gain to provide height of first half wave of received signal reaching 20 % of total A-Scan height

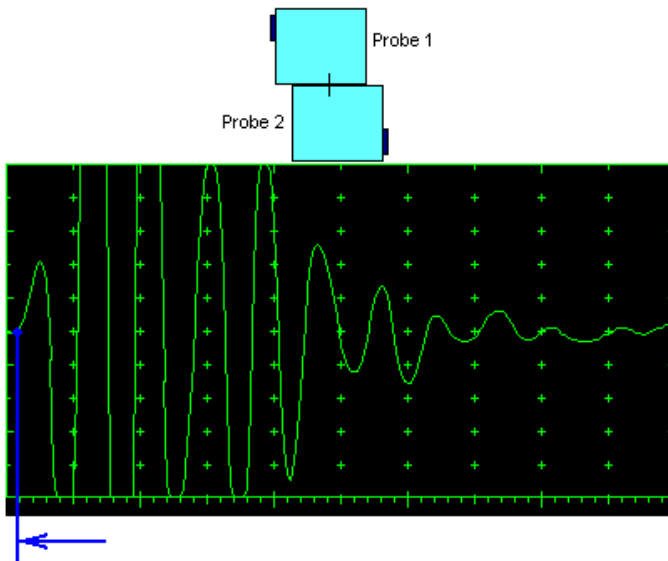

**Stage 4:** Decrease Range to provide ~ 50% of the A-Scan width occupied by the signal

**Stage 5:** Start increasing of Display Delay aiming displacement of signal's start point to beginning of A-Scan horizontal base

**Stage 6:** Stop Display Delay manipulation upon reaching the target – at this moment value of Display Delay will represent *Accumulated Delay of the Probes Pair*

**Accumulated Probe Pair Delay = Display Delay**

UDS3-5 - ISONIC Pulser/Receiver

|      |               |          |   |   |   |
|------|---------------|----------|---|---|---|
| 1    | Gain          | 32 dB    | ← | 1 | → |
| 1    | Range         | 15.3 mm  | ← | 2 | → |
| 100  | US Velocity   | 5920 m/s | ← | 3 | → |
| 0.01 | Display Delay | 7.85 μs  | ← | 4 | → |
| 5    | Reject        | 0 %      | ← | 5 | → |

**BASICS** | **PULSER** | **RECEIVER** | **GATE A** | **Menu**  
**GATE B** | **ALARM** | **DAC/TCG** | **MEASURE** | **Selection**

Close | Alarm | Value: OFF | Freeze | Save | Open | Print | I | DGS

### 6.5.1.2. Display Delay and Range

Display Delay depends on Accumulated Probe Pair Delay, Probe Separation, and USVelocity:

$$Display\ Delay = Probe\ Delay + Probe\ Separation / USVelocity$$

whereas:

- **USVelocity** is the *actual value of longitudinal wave velocity in the material*, of which the object under test is made
- **Probe Separation** is the distance between incidence points of the emitting and receiving TOFD probes measured along the lateral wave trace:

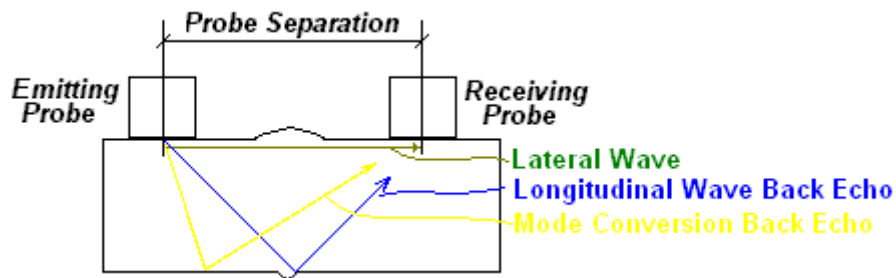

**Probe Separation** should be optimized according to Inspection procedure and probes positions in the TOFD fixture to be fixed upon. **Display Delay** and **Range** to be adjusted then to provide representing of signals according to Inspection procedure – the typical examples are given below for 40 mm thickness welded plates.

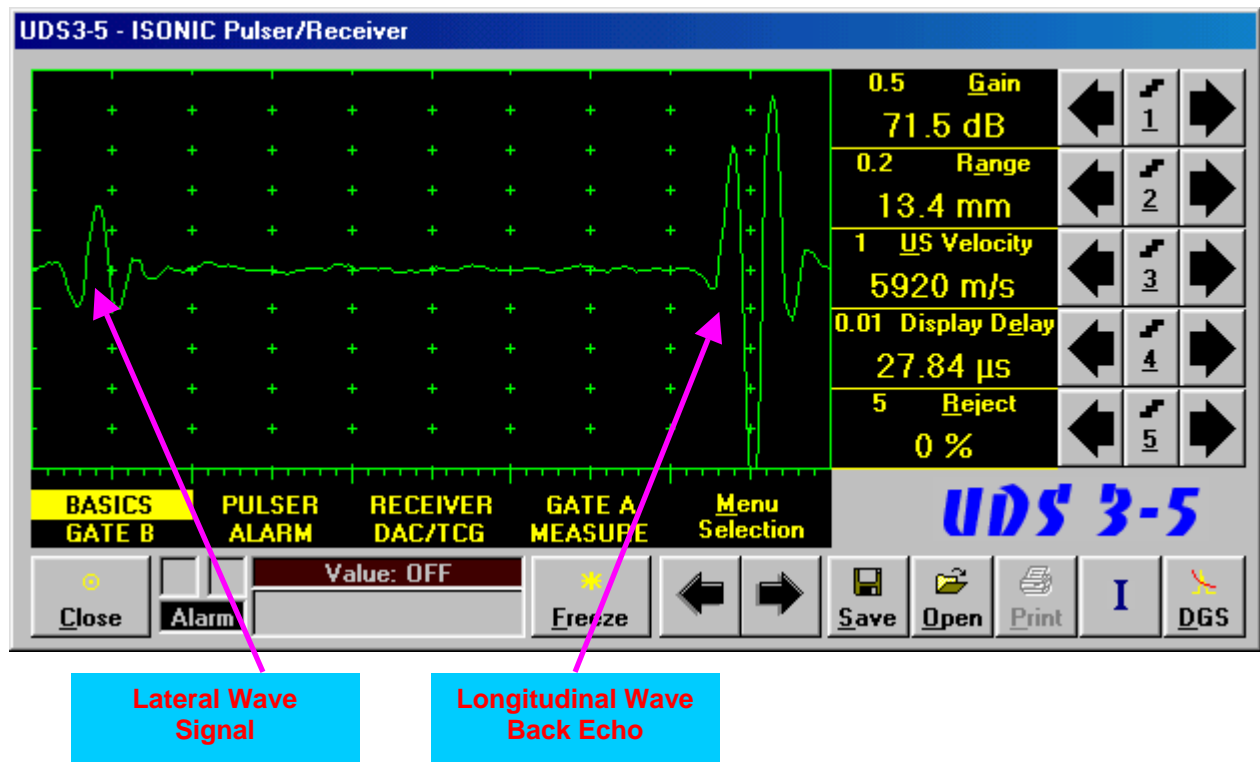

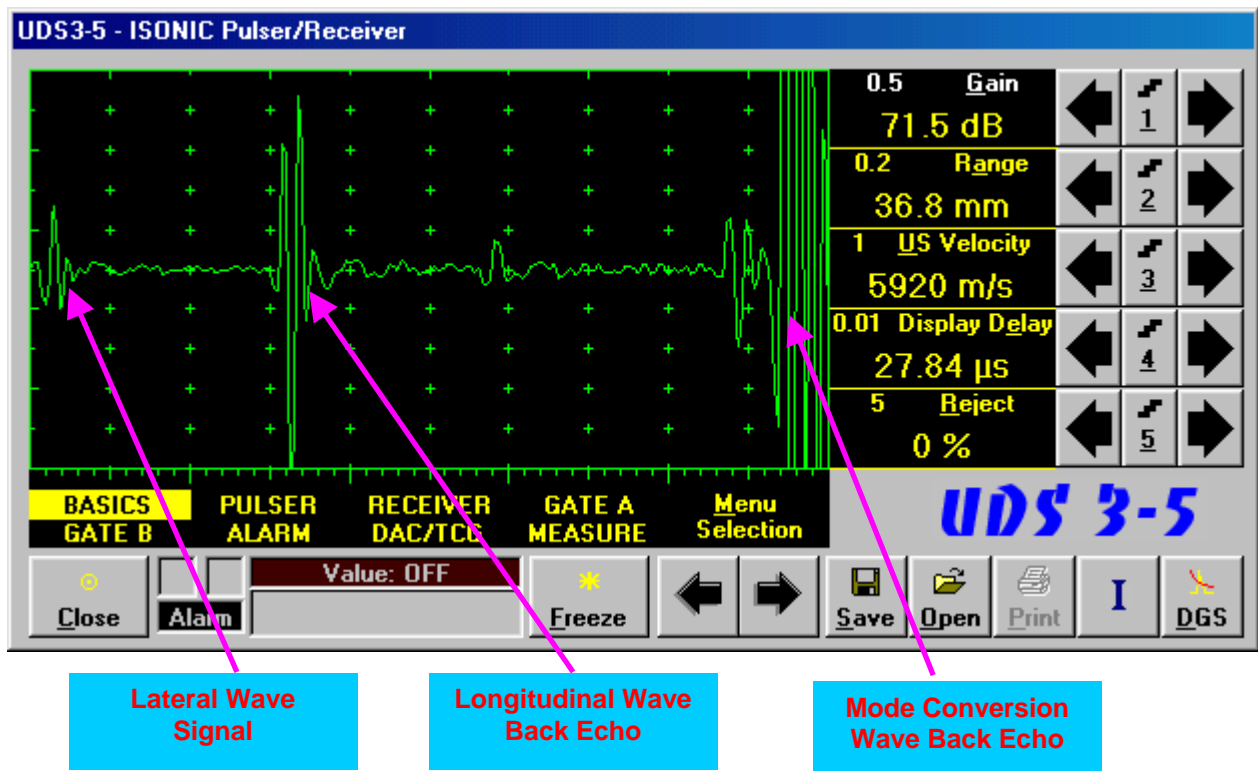

### 6.5.1.3. Gain

Depending on Inspection procedure (Inspection specs) **Gain** may be setup with the reference to:

- Representative flaw sample
- Artificial diffractors in the form of EDM notches or V-shaped notches
- Side drilled holes
- Grain noise
- Lateral wave signal amplitude

For both examples above the typical procedure of **Gain** setting was provided through bringing height of lateral wave signal to 30% of **A-Scan** height

### 6.5.1.4. Probe Separation

**Probe Separation** must be properly defined and entered to have the ability of precise defects sizing at postprocessing stage. Most widely used way of **Probe Separation** determining is mechanical measuring of distance between **TOFD** probes excitation points by using a scaled ruler. However mechanical measurements are not accurate and their implementation becomes quite complicate for objects with curved surfaces:

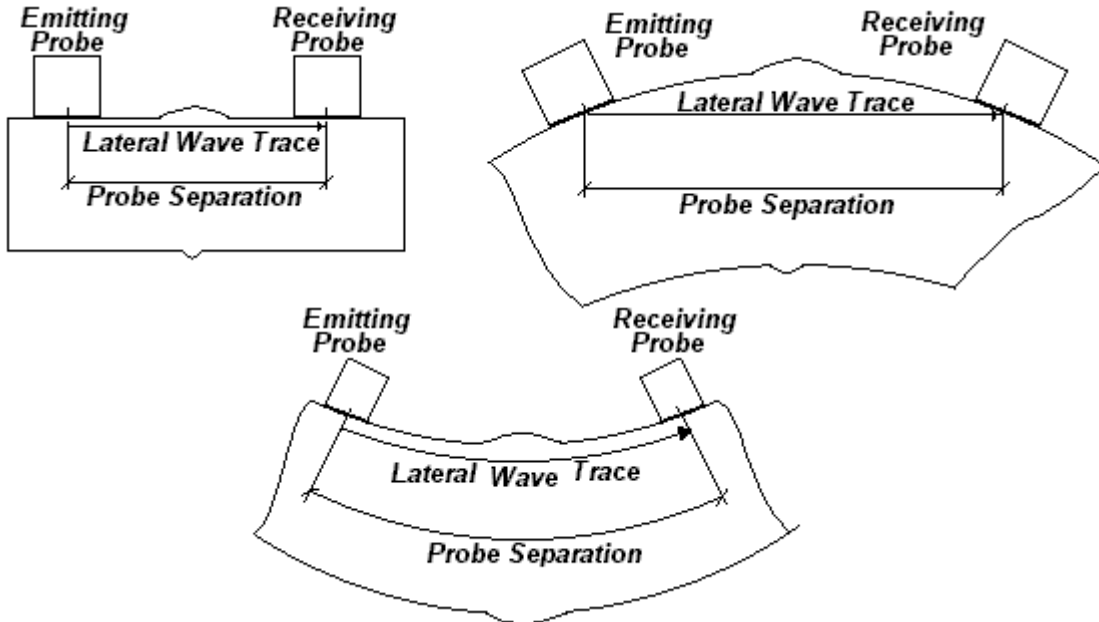

Probe Separation may be defined more precisely through the way as below:

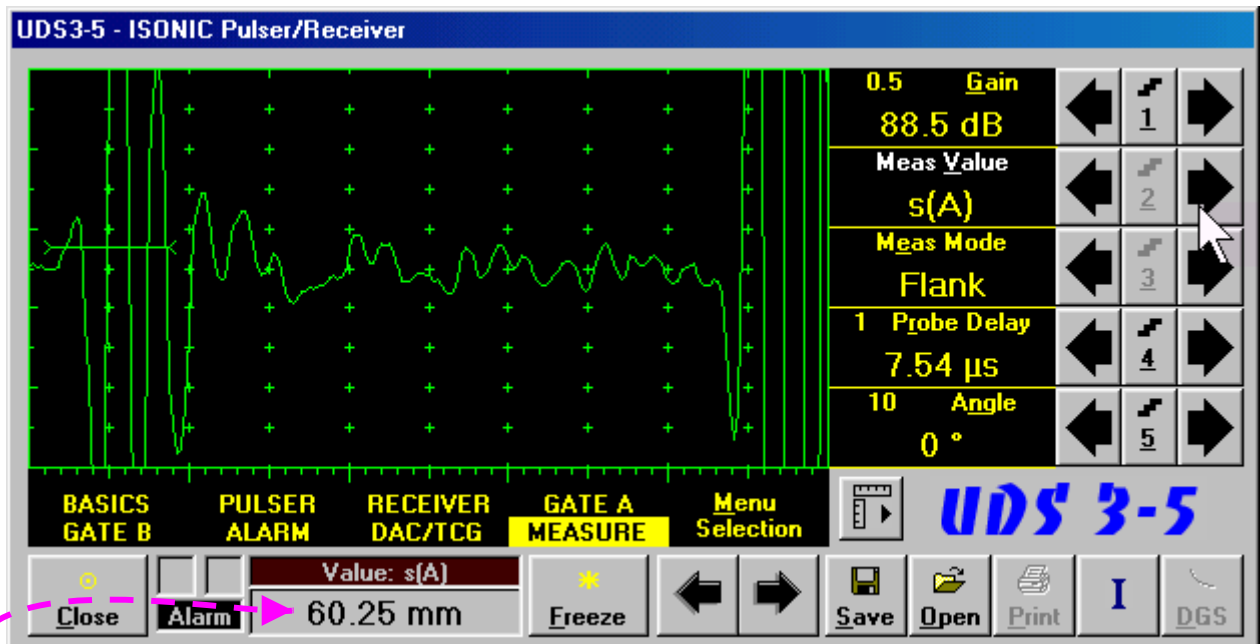

- ❑ Increase **Gain** to provide height of first half wave of lateral wave signal reaching 10-20 % of total **A-Scan** height
- ❑ Activate **Gate A**, setup **aThreshold** to 5%(submenu **GATE A**)
- ❑ Select **s(A)** as **Meas Value** and set **Meas Mode** as **Flank** (submenu **MEASURE**)
- ❑ Provide rising edge of first half wave of lateral wave will cross **Gate A**
- ❑ Define **Probe Separation** as **Probe Separation = 2 × s(A)** whereas **s(A)** is the digital readout taken from **Value** box

## 6.5.2. t-TOFD and TOFD – Implementation

### 6.5.2.1. t-TOFD – Prior to Scanning

t-TOFD control panel is shown below

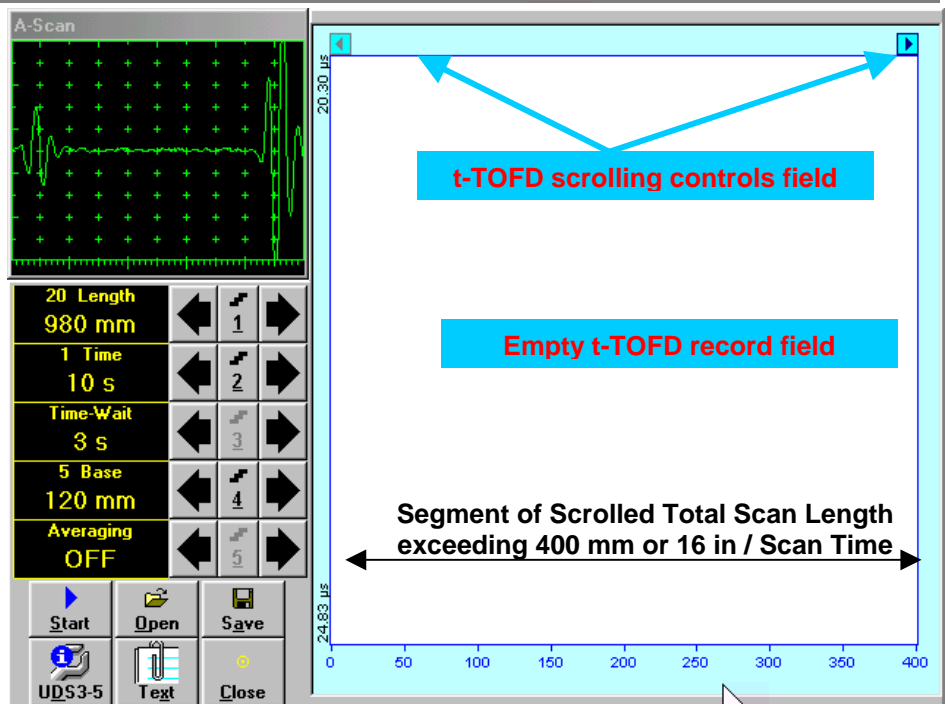
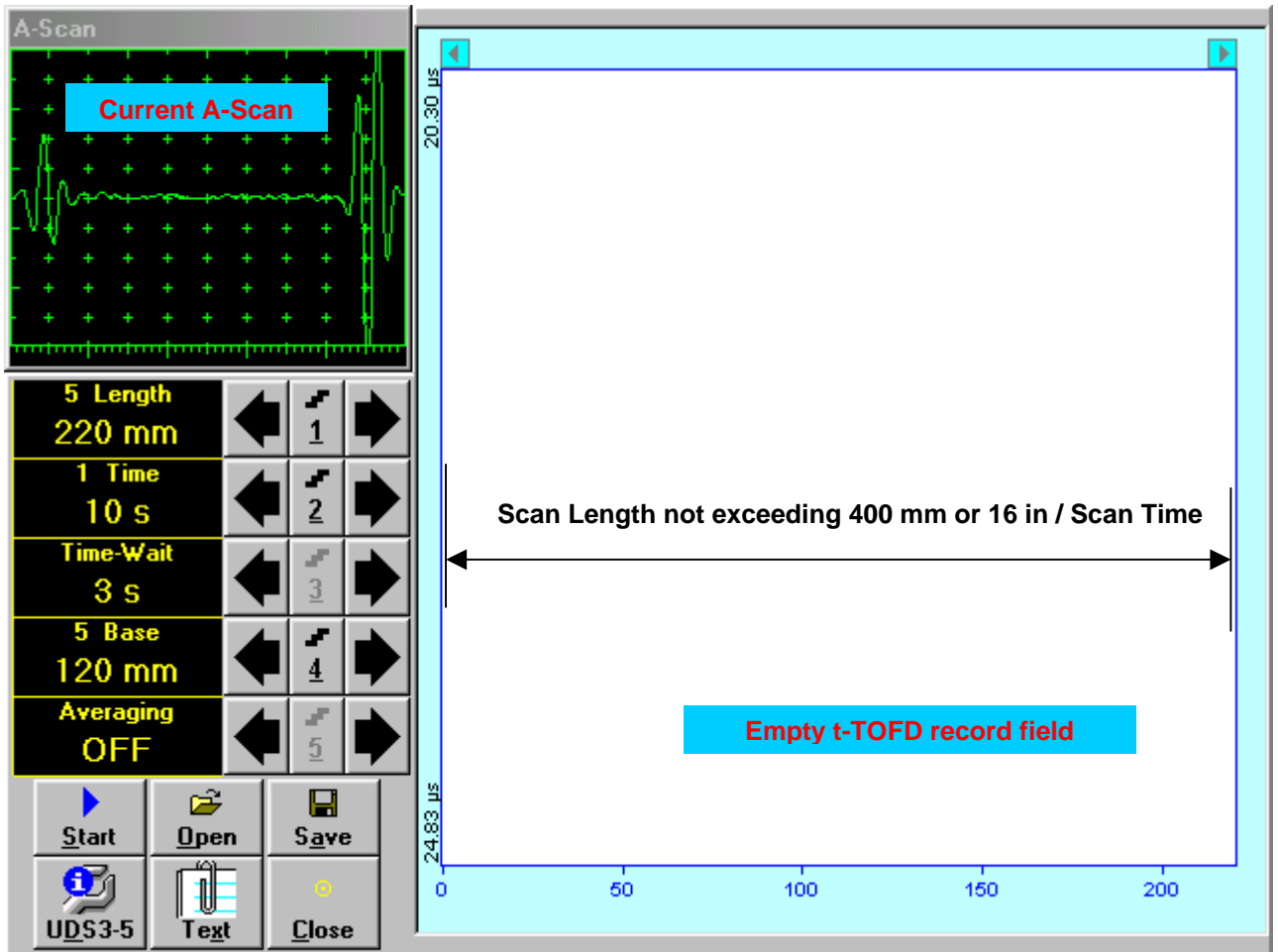

## Scan Length and Scan Time

**Length** represents length of section of test object to be displayed, over which probe will be scanning during recording period. **Time** (Scan Time) is the duration of recording period

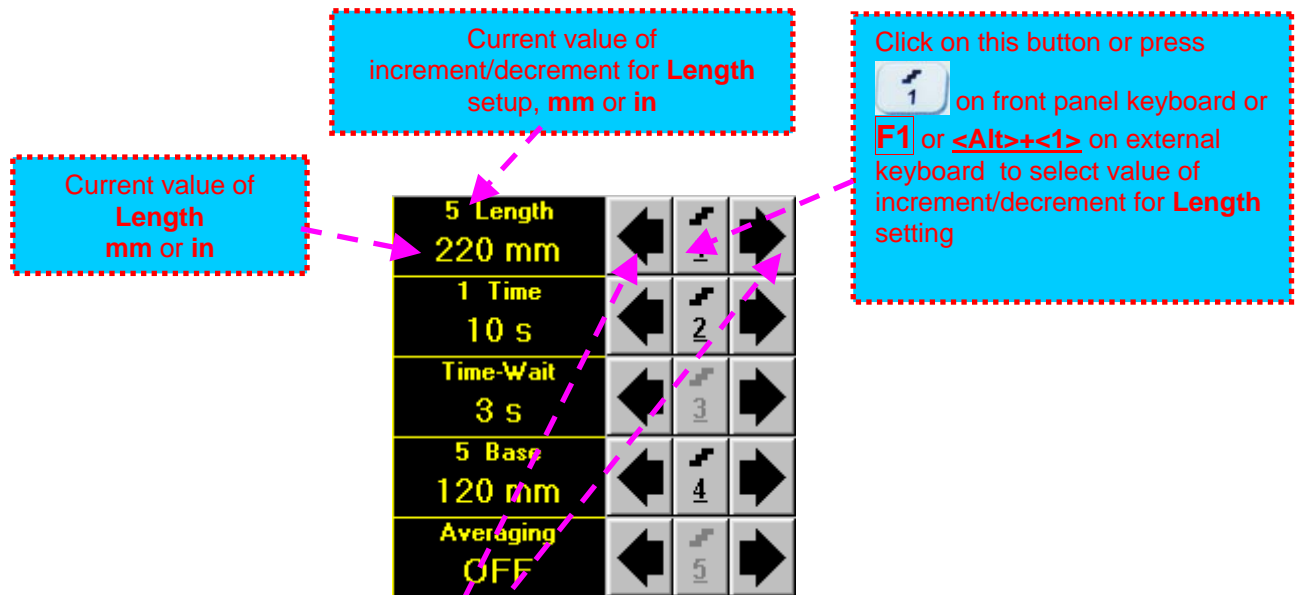

To control **Length** the following manipulations are applicable:

- **Mouse / Touch Screen**

- Click on corresponding button

- **Keyboard**

- Press [1] on front panel keyboard or F1 on external keyboard ⇒ **Length** fore color changes to white - then use [Up], [Right], [Left], [Down] on front panel keyboard or [Up], [Right], [Left], [Down] on external keyboard

- **Combined**

- Click on **Length** ⇒ **Length** fore color changes to white - then use [Up], [Right], [Left], [Down] on front panel keyboard or [Up], [Right], [Left], [Down] on external keyboard



The value of **Length** is adjustable between 50 and 1000 **mm** or 2 and 40 **in**

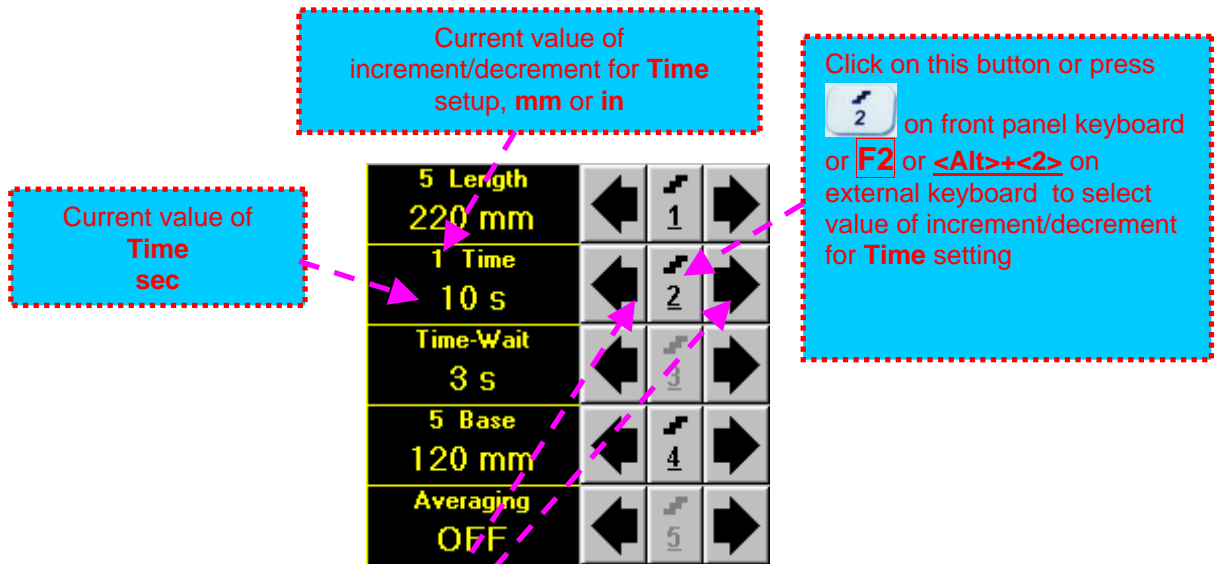









To control **Time** the following manipulations are applicable:









- **Mouse / Touch Screen**

- Click on corresponding **button**

- **Keyboard**

- Press  on front panel keyboard or **F2** on external keyboard ⇒ **Time** fore color changes to white - then use , , ,  on front panel keyboard or , , ,  on external keyboard

- **Combined**

- Click on **Time** ⇒ **Time** fore color changes to white - then use , , ,  on front panel keyboard or , , ,  on external keyboard



The value of **Time** is adjustable between 5 and 60 **sec**

## Time-Wait

**Time-Wait** is waiting time for intermissions preceeding **t-TOFD** recording, which starts unconditionally upon **Time-Wait** period is over

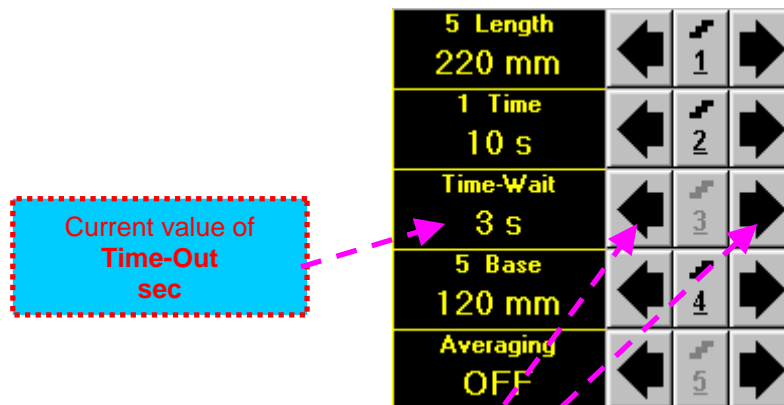









To control **Time-Wait** the following manipulations are applicable:









- **Mouse / Touch Screen**

- Click on corresponding button

- **Keyboard**

- Press  on front panel keyboard or **F3** on external keyboard ⇒ **Time-Wait** fore color changes to white - then use , , ,  on front panel keyboard or , , ,  on external keyboard

- **Combined**

- Click on **Time-Wait** ⇒ **Time-Wait** fore color changes to white - then use , , ,  on front panel keyboard or , , ,  on external keyboard



The value of **Time-Wait** is adjustable between 0 and 15 **sec**



## Base

**Base** represents **Probe Separation**

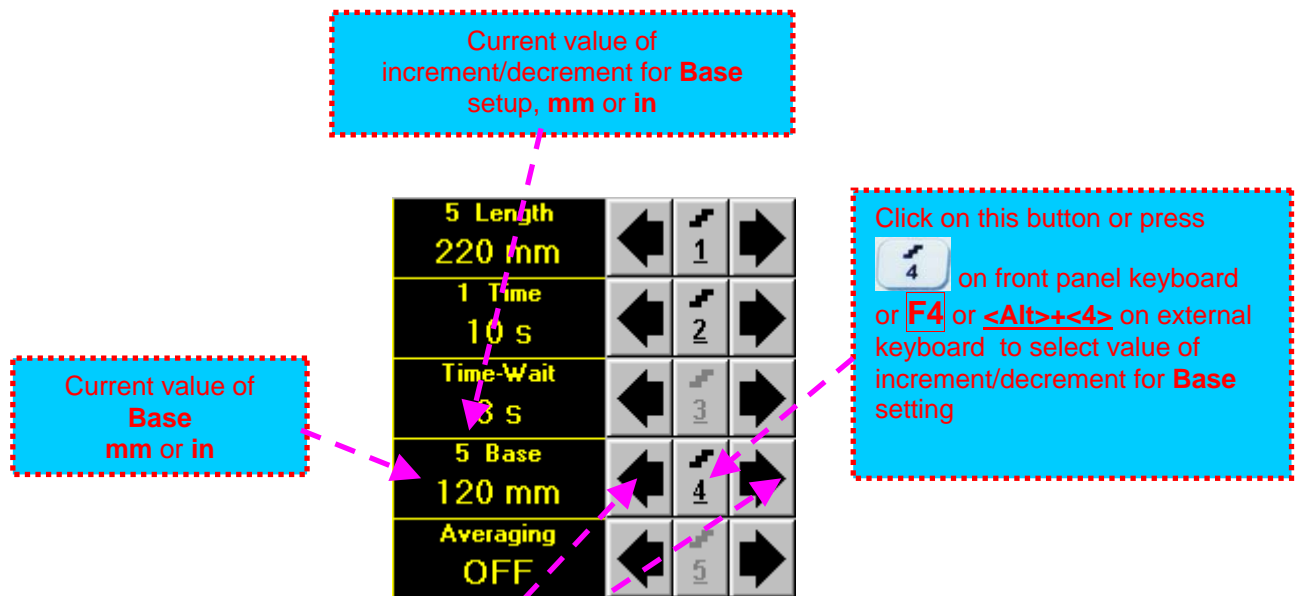

To control **Base** the following manipulations are applicable:

- **Mouse / Touch Screen**

- Click on corresponding button

- **Keyboard**

- Press on front panel keyboard or **F1** on external keyboard ⇒ **Base** fore color changes to white - then use , , , on front panel keyboard or , , , on external keyboard

- **Combined**

- Click on **Base** ⇒ **Base** fore color changes to white - then use , , , on front panel keyboard or , , , on external keyboard



The value of **Base** is adjustable between 25 and 500 **mm** or 1 and 20 **in**

## Averaging

**Averaging** of sequential **A-Scans** is required sometimes to improve signal to noise ratio of the **t-TOFD** record

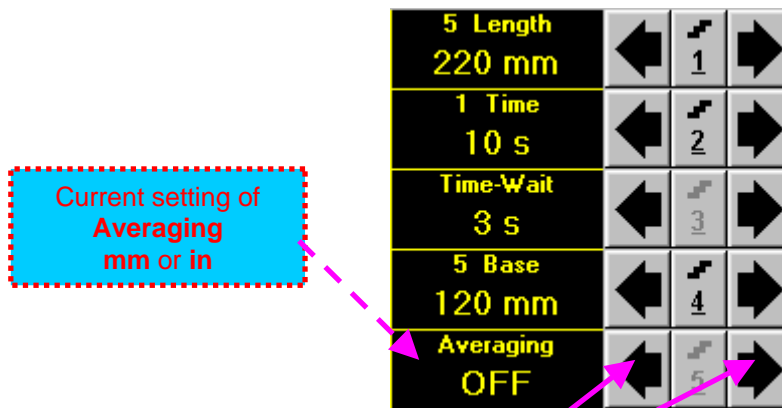









To control **Averaging** the following manipulations are applicable:







- **Mouse / Touch Screen**

- Click on corresponding **button**

- **Keyboard**

- Press  on front panel keyboard or **F5** on external keyboard ⇒ **Averaging** fore color changes to white - then use , , ,  on front panel keyboard or , , ,  on external keyboard

- **Combined**

- Click on **Averaging** ⇒ **Averaging** fore color changes to white - then use , , ,  on front panel keyboard or , , ,  on external keyboard



**Averaging** may be either inactive (**OFF**) or setup for factor **2** or **4** or **8**



## Insert Text Note



Refer to paragraph 6.3.2.1 of this Operating Manual



## Preview UDS 3-5 Settings



Refer to paragraph 6.3.2.1 of this Operating Manual

### **Start/Stop t-TOFD recording**

Click on  or press  on front panel keyboard or **F8** or **<Alt>+<S>** on external keyboard to start **t-TOFD** recording

 button becomes invisible since **t-TOFD** recording starts.  button occupies its position.

Click on  or press  on front panel keyboard or **F8** or **<Alt>+<S>** on external keyboard to terminate **t-TOFD** recording prior to automatic completion

 button becomes invisible after completion / termination of **t-TOFD** record.  button returns to its position

### **Save record into a file**

Refer to paragraph 6.3.2.1 of this Operating Manual



### **Open record from a file and starting postprocessing session**

Refer to paragraph 6.3.2.1 of this Operating Manual

### **Return to UDS 3-5 main operating surface**

Refer to paragraph 6.3.2.1 of this Operating Manual

### 6.5.2.2. t-TOFD – Scanning

- Apply probes pair to test object in the start point of selected scanning line
- Click on  or press  on front panel keyboard or **F8** or **<Alt>+<S>** on external keyboard
- Guide probe pair over the scanning line synchronously with *Position Icon* moving with constant speed above **t-TOFD** record field – typical scanning progress display during is shown and explained below

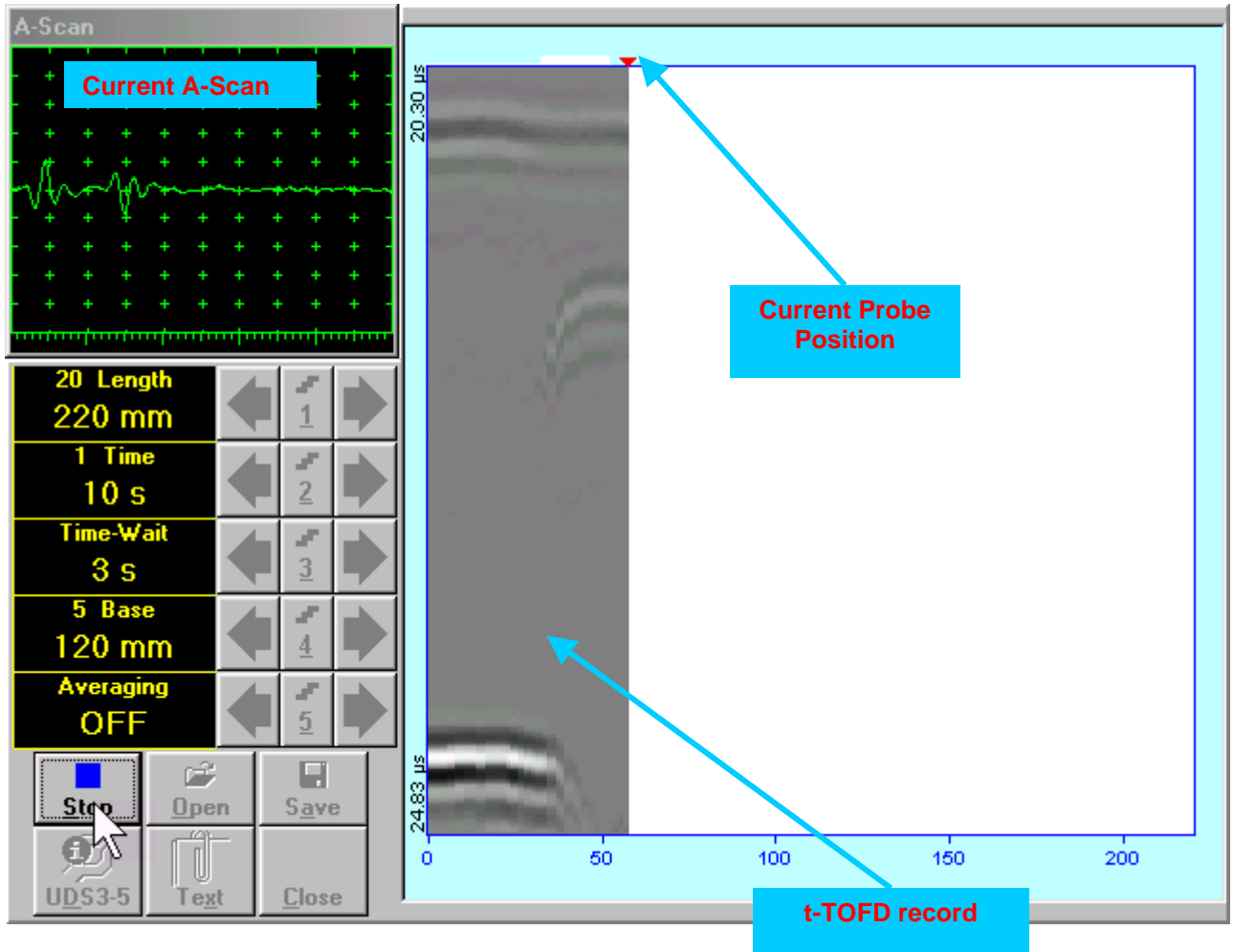

### 6.5.2.3. TOFD – Prior to Scanning

TOFD control panel is shown below

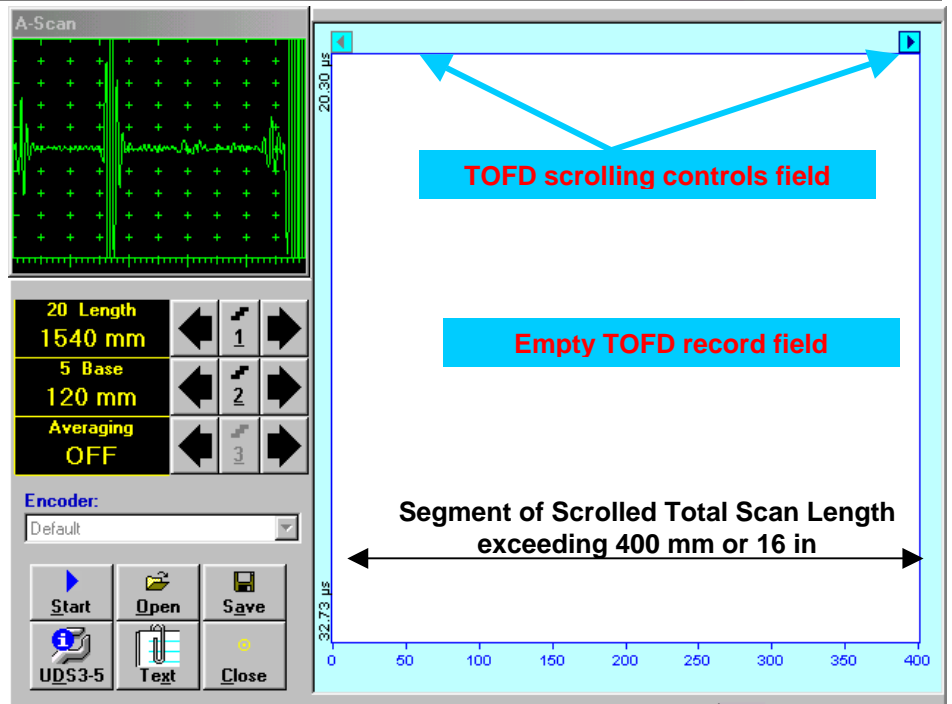
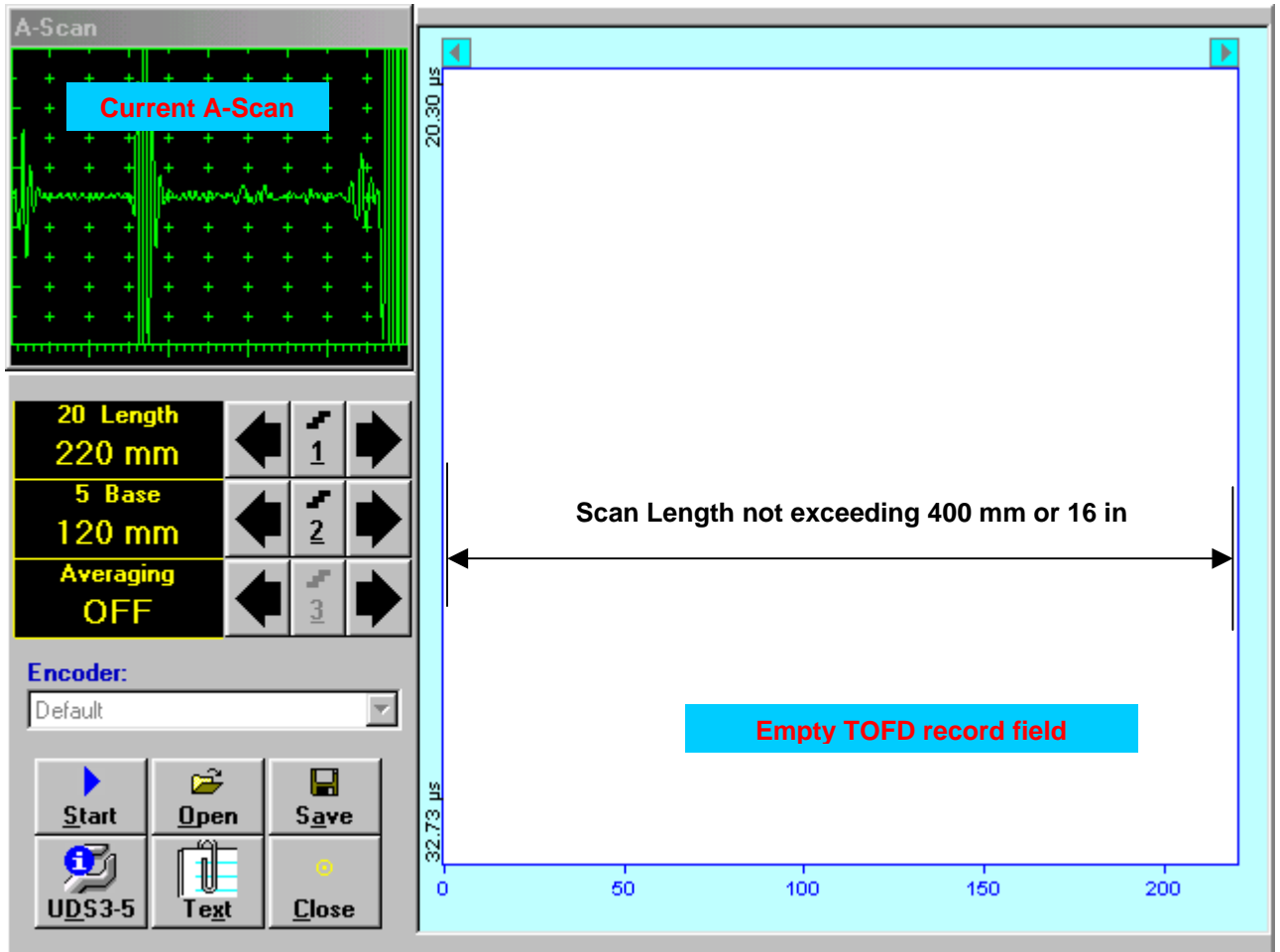





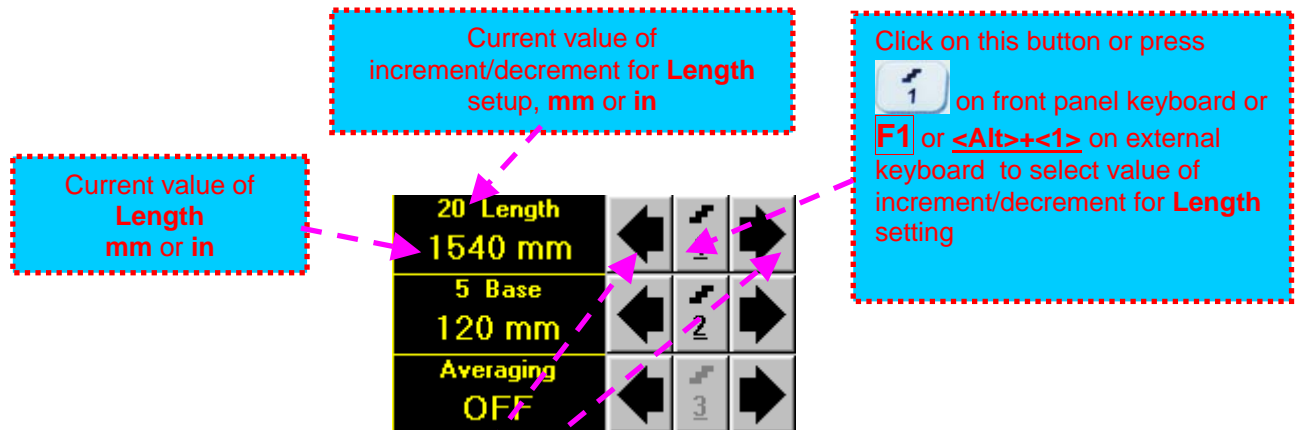











## Scan Length

**Length** represents length of section of test object to be displayed, over which probe will be scanning during recording period



To control **Length** the following manipulations are applicable:

- **Mouse / Touch Screen**
  - Click on corresponding button
- **Keyboard**
  - Press  on front panel keyboard or **F1** on external keyboard ⇒ **Length** fore color changes to white - then use , , ,  on front panel keyboard or , , ,  on external keyboard
- **Combined**
  - Click on **Length** ⇒ **Length** fore color changes to white - then use , , ,  on front panel keyboard or , , ,  on external keyboard



The value of **Length** is adjustable between 50 and 20000 **mm** or 2 and 800 **in**

## Base

**Base** represents **Probe Separation**

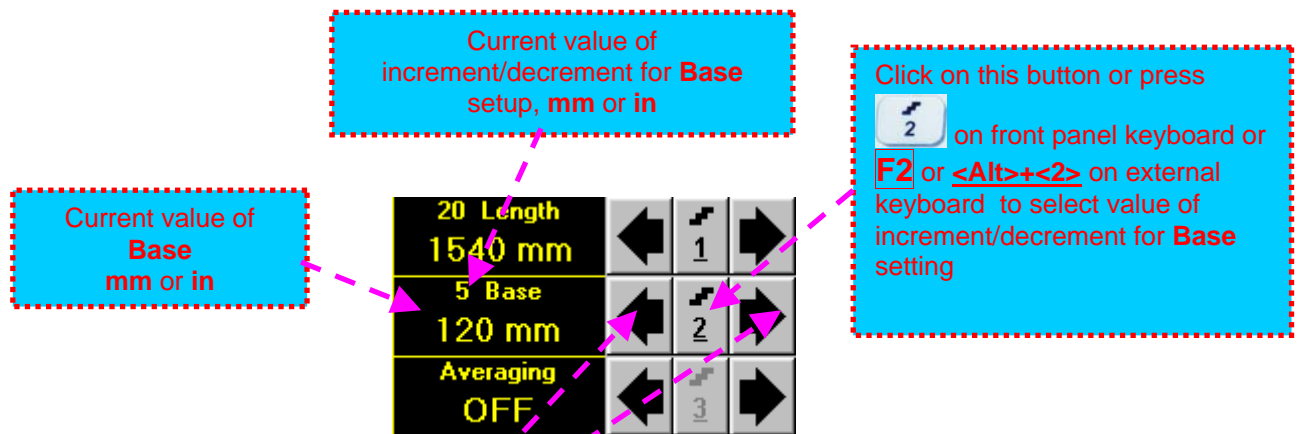

To control **Base** the following manipulations are applicable:

- **Mouse / Touch Screen**

- Click on corresponding **button**

- **Keyboard**

- Press on front panel keyboard or **F2** on external keyboard ⇒ **Base** fore color changes to white - then use , , , on front panel keyboard or , , , on external keyboard

- **Combined**

- Click on **Base** ⇒ **Base** fore color changes to white - then use , , , on front panel keyboard or , , , on external keyboard



The value of **Base** is adjustable between 25 and 500 **mm** or 1 and 20 **in**

## Averaging

**Averaging** of sequential **A-Scans** is required sometimes to improve signal to noise ratio of the **TOFD** record

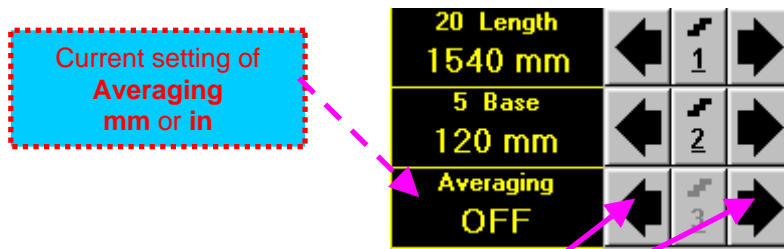







To control **Averaging** the following manipulations are applicable:









- **Mouse / Touch Screen**

- Click on corresponding **button**

- **Keyboard**

- Press  on front panel keyboard or **F3** on external keyboard ⇒ **Averaging** fore color changes to white - then use , , ,  on front panel keyboard or , , ,  on external keyboard

- **Combined**

- Click on **Averaging** ⇒ **Averaging** fore color changes to white - then use , , ,  on front panel keyboard or , , ,  on external keyboard



**Averaging** may be either inactive (**OFF**) or setup for factor **2** or **4** or **8**

## Encoder

Select encoder to be used through appropriate box



Clamp fixture holding **TOFD** probe pair into encoder – refer to Chapter 7 of this Operating Manual  
Connect encoder to its input on the rear panel of **ISONIC 2007** instrument

## Insert Text Note



Refer to paragraph 6.3.2.1 of this Operating Manual





## Preview UDS 3-5 Settings

Refer to paragraph 6.3.2.1 of this Operating Manual



### **Start/Stop TOFD recording**

Click on  or press  on front panel keyboard or **F8** or **<Alt>+<S>** on external keyboard to start **TOFD** recording

 button becomes invisible since **TOFD** recording starts.  button occupies its position. Click on  or press  on front panel keyboard or **F8** or **<Alt>+<S>** on external keyboard to terminate **TOFD** recording

 button becomes invisible after termination of **TOFD** record.  button returns to its position

### **Save record into a file**

Refer to paragraph 6.3.2.1 of this Operating Manual

### **Open record from a file and starting postprocessing session**

Refer to paragraph 6.3.2.1 of this Operating Manual

### **Return to UDS 3-5 main operating surface**

Refer to paragraph 6.3.2.1 of this Operating Manual

### 6.5.2.4. TOFD – Scanning

- Apply probes pair to test object in the start point of selected scanning line
- Click on **Start** or press **I** on front panel keyboard or **F8** or **<Alt>+<S>** on external keyboard
- Guide probe pair over the scanning line – typical scanning progress display during is shown and explained below

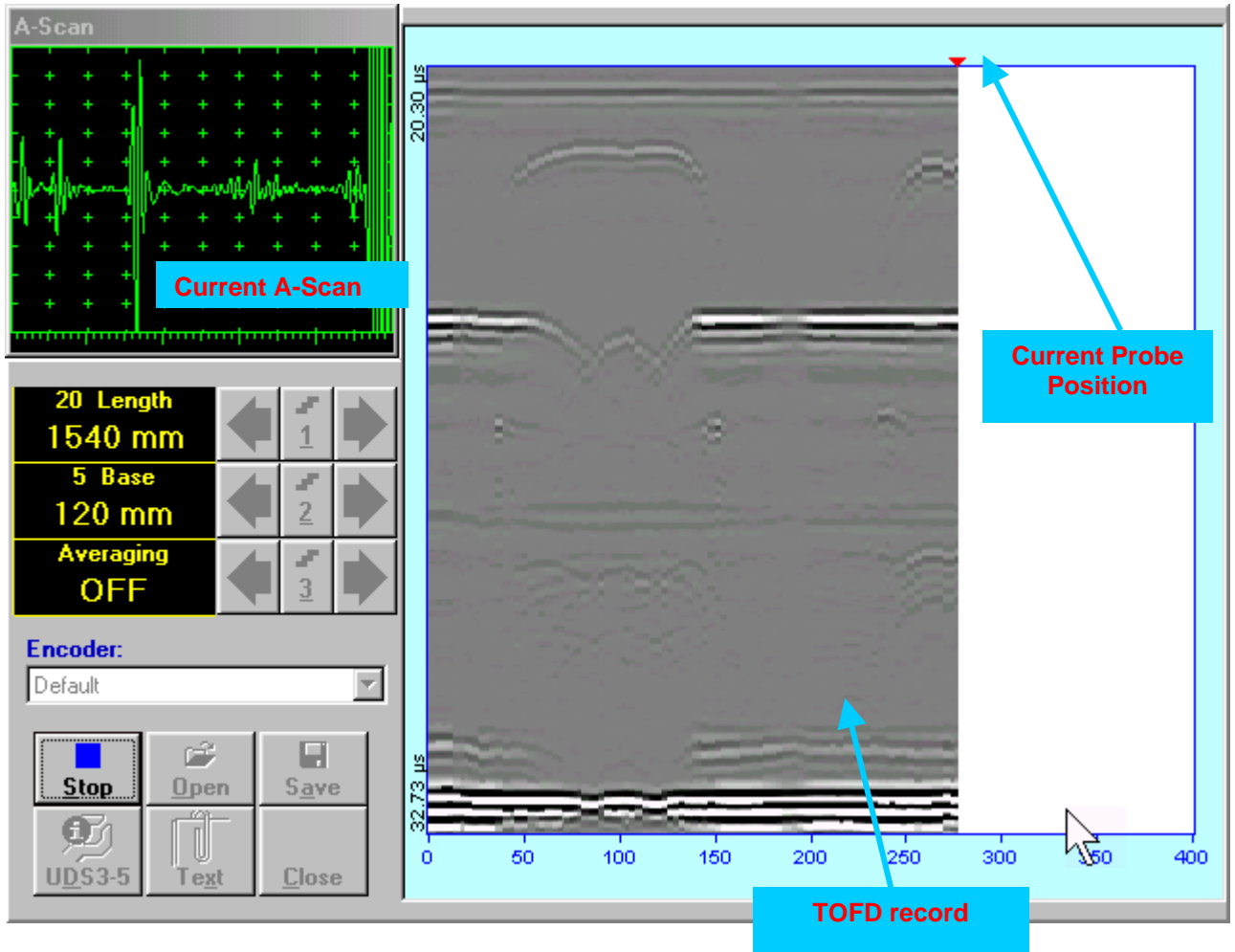

### 6.5.2.5. t-TOFD / TOFD – Postprocessing

Versatile postprocessing of **t-TOFD / TOFD** records is featured with:



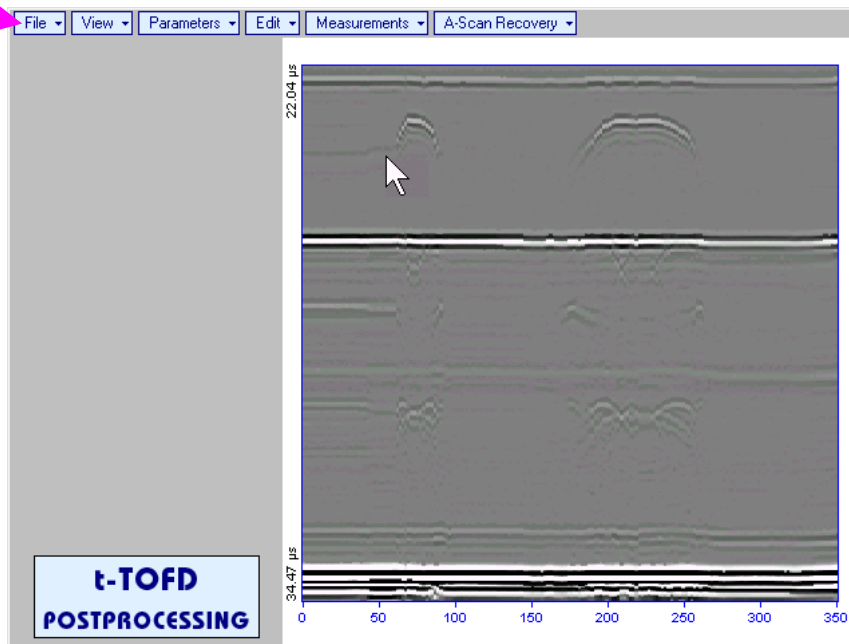

- ❑ Improvement of near to surface resolution through removal of lateral wave and back echo records from **t-TOFD / TOFD Map**, zooming **t-TOFD / TOFD Map** accompanied with appropriate **A-Scan** expanding
- ❑ Linearization and straightening of **t-TOFD / TOFD Map**
- ❑ Increasing contrast of **t-TOFD / TOFD** images through varying **Gain** and rectification
- ❑ Defects pattern recognition and sizing

The screen as below appears upon opening file. All postprocessing procedures are performed through **menu bar** – touch screen stylus or front panel or external mouse to be used





#### Menu Bar Functions

- **File→Open** – opens new **t-TOFD / TOFD** file
- **File→Snapshots→Add Snapshot** – stores current postprocessing screen snapshot accompanied with appropriate settings and measurements into *postprocessing session memory stack*
- **File→Snapshots→Restore Snapshot** – recalls earlier stored postprocessing screen snapshot accompanied with appropriate settings and measurements from *postprocessing session memory stack*
- **File→Snapshots→Delete Snapshot** – deletes earlier stored postprocessing screen snapshot accompanied with appropriate settings and measurements from *postprocessing session memory stack*
- **File→Print** – prints out postprocessing screen snapshot(s) accompanied with appropriate settings and measurements
- **File→Exit** – returns to **t-TOFD / TOFD** control panel
- **View→Instrument** – indicates setup of **UDS 3-5** Pulser Receiver used for scanning when file was created
- **View→Inspection Data** – indicates operator's comments entered prior to scanning
- **View→Coloring→Grayscale / View→Coloring→Thermal** – selects base color for **t-TOFD / TOFD** image
- **View→TOFD→Logic→Negative / View→TOFD→Logic→Positive** – selects black / white tones for representation of positive/negative half waves components of **RF A-Scan** on the **TOFD Map** – refer also to paragraph 9.2.2 of this Operating Manual
- **View→TOFD→Contrast→Natural / View→TOFD→Contrast→Soft / View→TOFD→Contrast→Sharp** – selects contrast of the **TOFD Map** – refer also to paragraph 9.2.2 of this Operating Manual

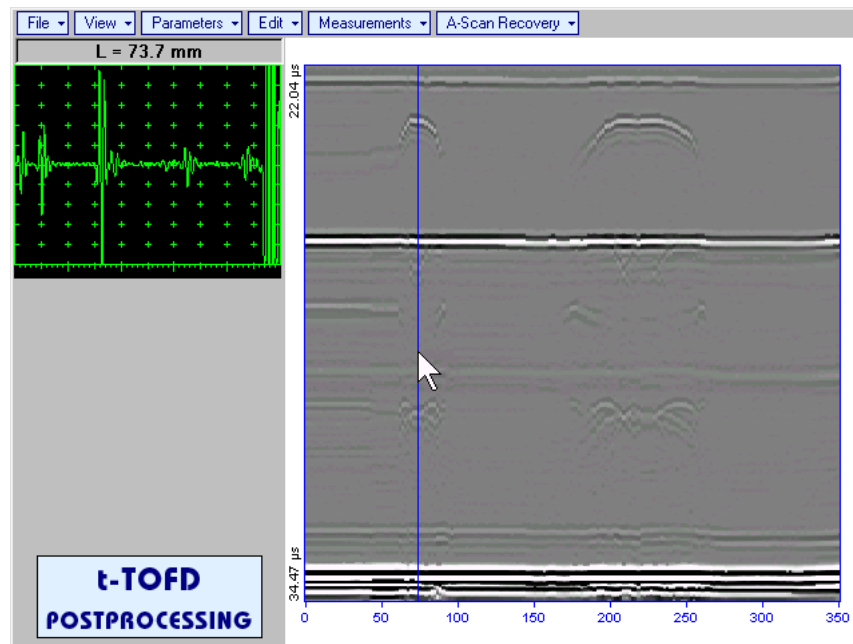
- **A-Scan Recovery→ON** – generates *cursor corresponding to A-Scan base line* that may be guided over **t-TOFD / TOFD** image using either touch screen stylus or mouse or ,  on front panel keyboard or ,  on external keyboard – corresponding **A-Scan** is recovered synchronously according to *A-Scan base line cursor* position. Indication of starting position of cursor (**L**) corresponding to the position of **TOFD** probes pair accompanies recovered **A-Scan**



To fix position of *A-Scan base line cursor* with corresponding recovered **A-Scan** left mouse click or release touch screen stylus or press  on front panel keyboard or **Enter** on external keyboard

To interrupt recovery of **A-Scans** right mouse click or press  on front panel keyboard or **Esc** on external keyboard

- **A-Scan Recovery→OFF** – erases *A-Scan base line cursor*, indicator of its position, and recovered **A-Scan**

- **View→Coloring→Rectified** – switches between rectified and RF presentation of t-TOFD / TOFD image

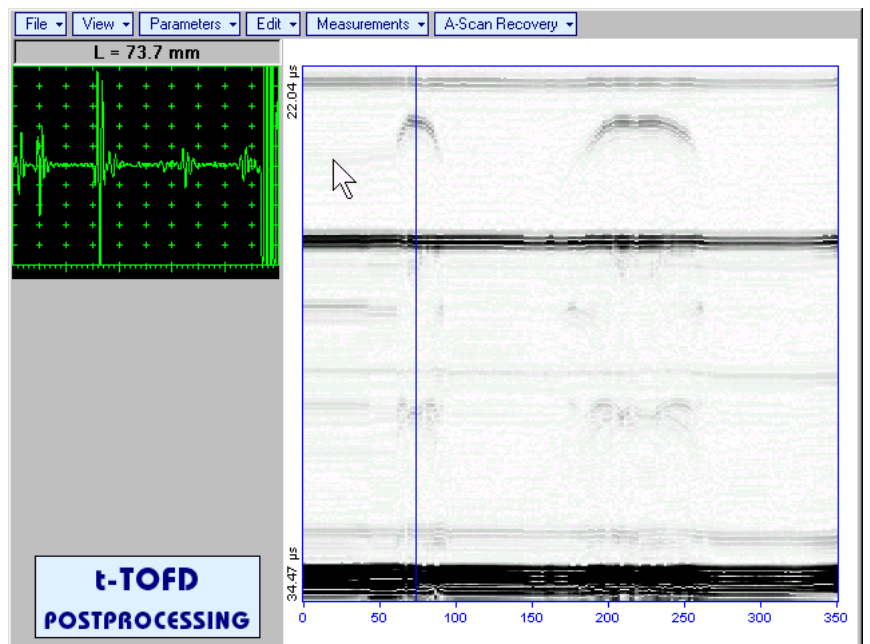
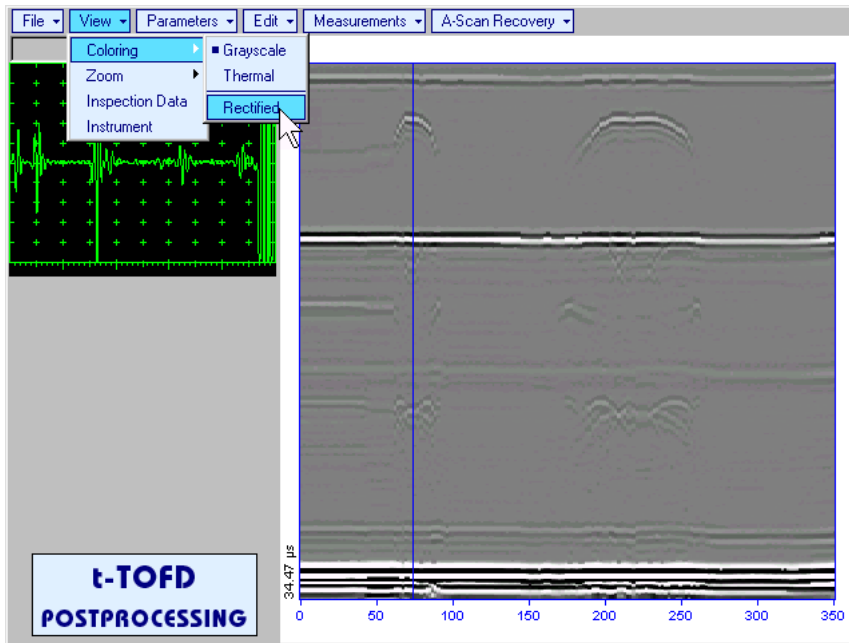

- **View→Zoom→Zoom Factor%** – expands **t-TOFD / TOFD** image along time line (vertically)

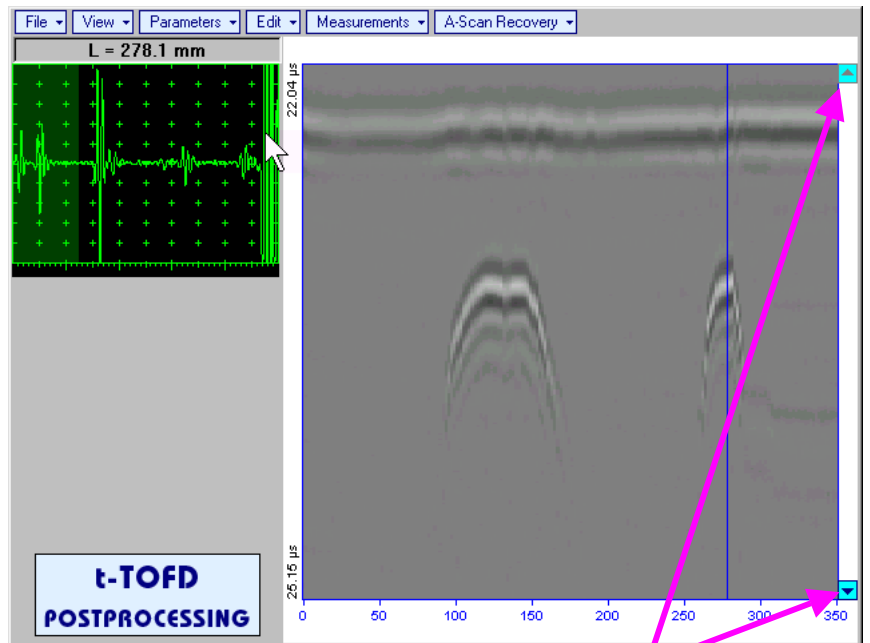
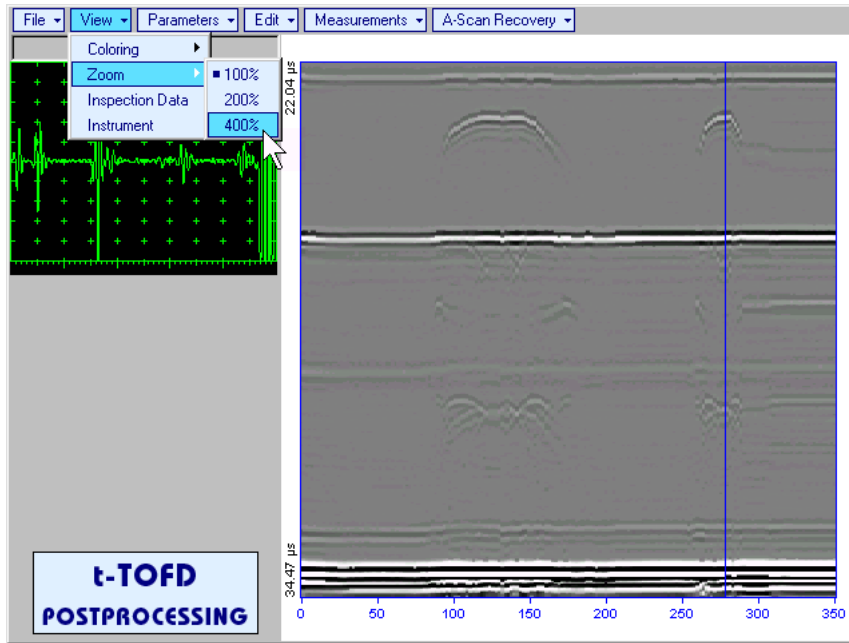

Expanded **t-TOFD / TOFD** image may be scrolled it vertically using appropriate **buttons**

Green background highlights segment of recovered **A-Scan** corresponding to visible part of **t-TOFD / TOFD** image. Said segment moves over recovered **A-Scan** background while scrolling **t-TOFD / TOFD** image vertically

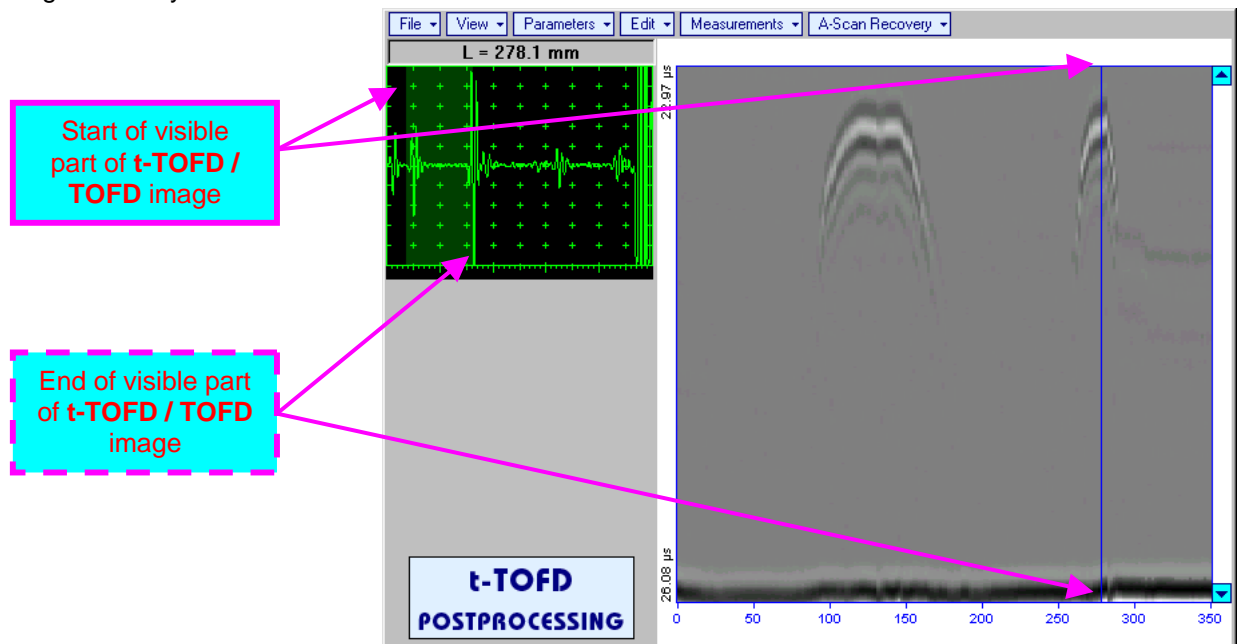

Segment of recovered **A-Scan** corresponding to visible part of **t-TOFD / TOFD** image may be expanded through double click on it – whole **A-Scan** background is green for the expanded segment. Vertical scrolling of **t-TOFD / TOFD** image causes appropriate varying of **Display Delay** for recovered **A-Scan**

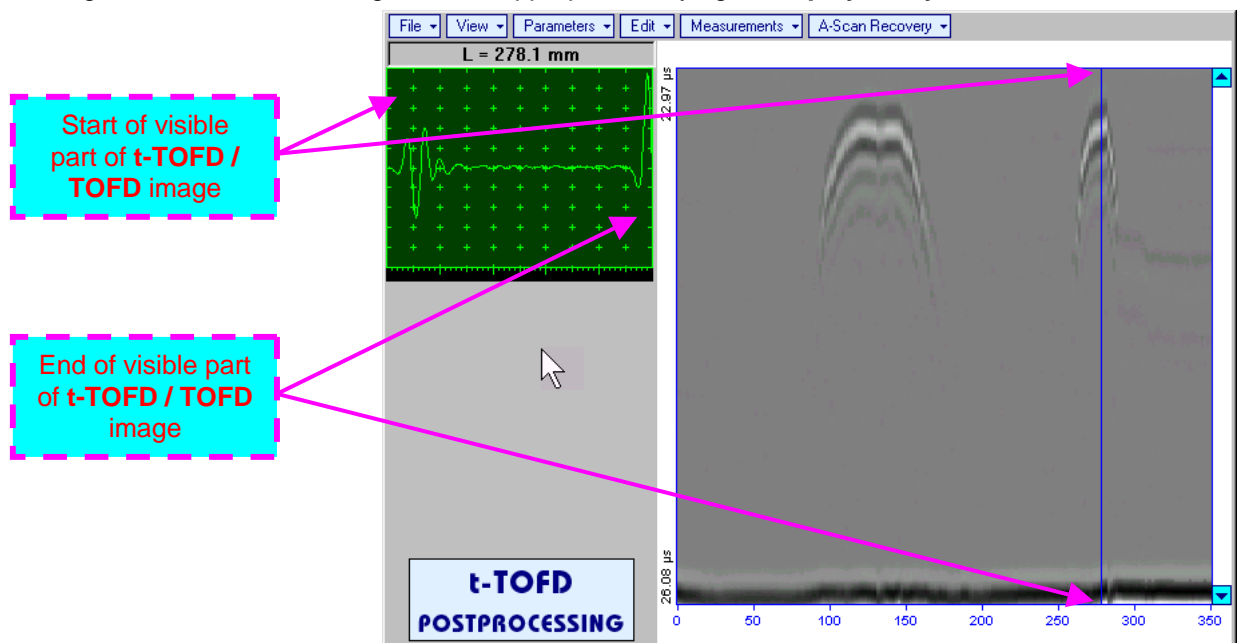

To return to complete recovered **A-Scan** visibility double click on **A-Scan** area



- ◆ Zoom function is available for **t-TOFD / TOFD** image composed of **A-Scans** longer than **5 μs**
- ◆ Possible zoom factors are defined by **ISONIC 2007** software automatically
- ◆ Maximal possible Zoom factor is **400%**



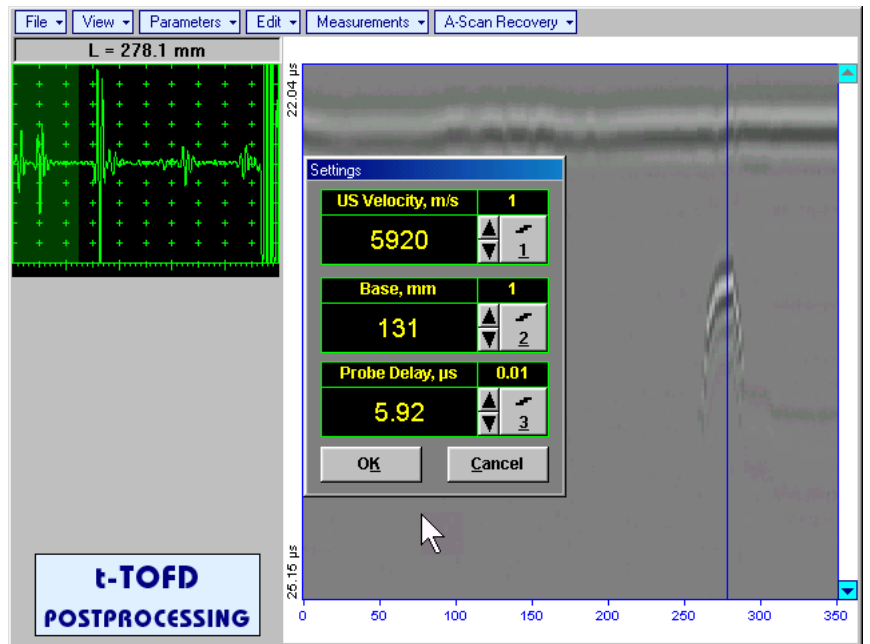
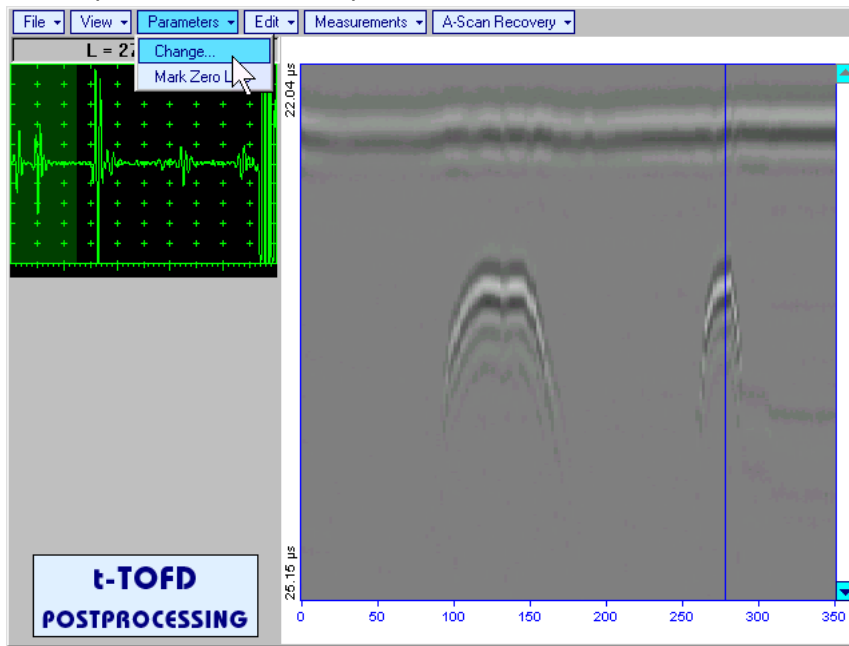

- **Parameters→Change...** – allows re-adjusting of basic parameters (**US Velocity**, **Base**, **Probe Delay**) for computation of defects depth and linearization of **t-TOFD / TOFD** image



On completing click **OK** or press **Enter** on front panel keyboard or **Enter** on external keyboard

To negate re-adjustments click on **Cancel** or press **ESC** on front panel keyboard or **Esc** on external keyboard





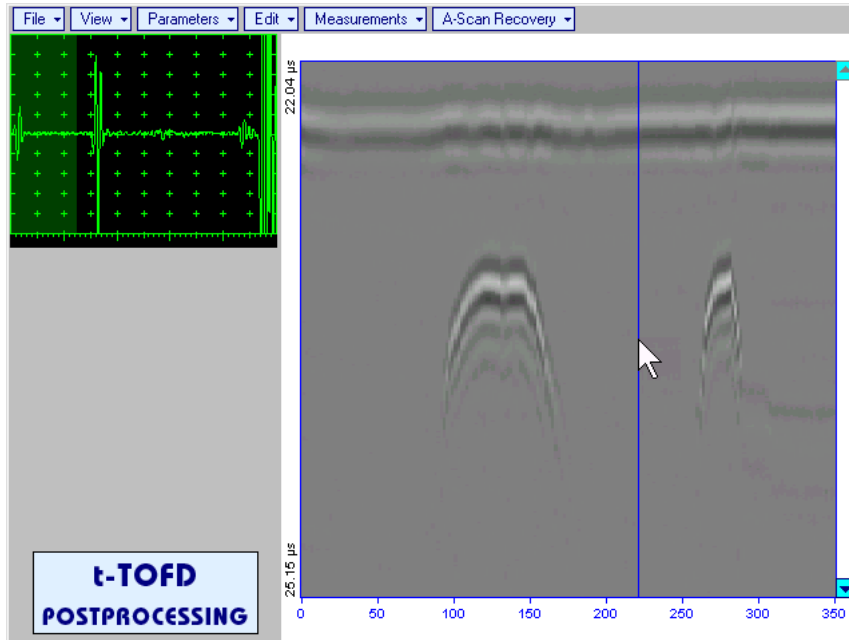

- Parameters → Mark Zero Line** – allows re-adjusting of **Probe Delay** for computation of defects depth and linearization of **t-TOFD / TOFD** image through mark of start point of lateral wave signal on the recorded **t-TOFD / TOFD** image with reference to recovered **A-Scan**. Initially this function generates *cursor corresponding to A-Scan base line* that may be guided over **t-TOFD / TOFD** image using either touch screen stylus or mouse or ,  on front panel keyboard or ,  on external keyboard – corresponding **A-Scan** is recovered synchronously according to *A-Scan base line cursor* position



Upon selecting reference **A-Scan** with clear lateral wave left mouse click or press



on front panel keyboard or **Enter** on external keyboard – this generates horizontal cursor, which may be guided over **t-TOFD / TOFD** image using either touch screen stylus or

mouse or ,  on front panel keyboard or ,  on external keyboard

To mark the beginning of lateral wave signal corresponding to zero depth left mouse click or press



on front panel keyboard or **Enter** on external keyboard

To interrupt function at any moment right mouse click or



press on front panel keyboard or **Esc** on external keyboard

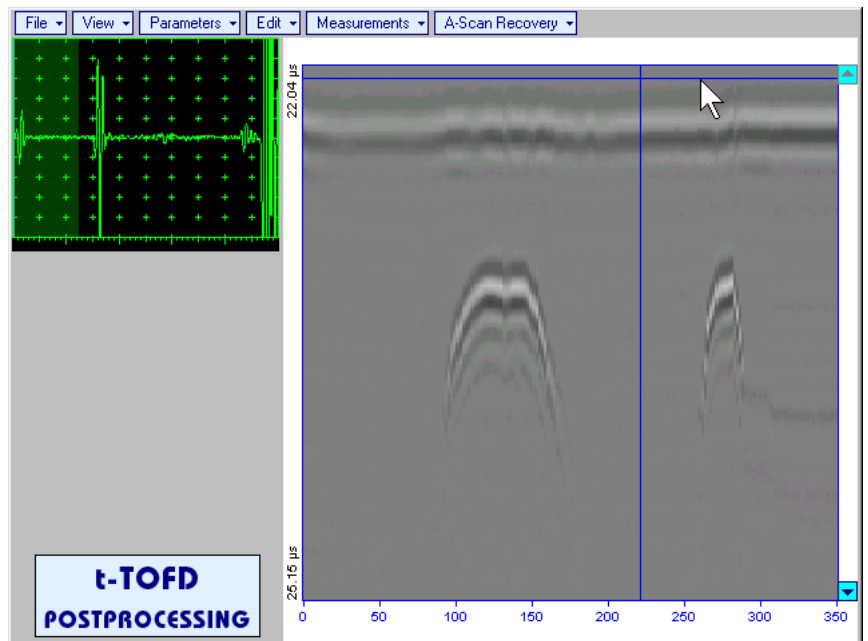



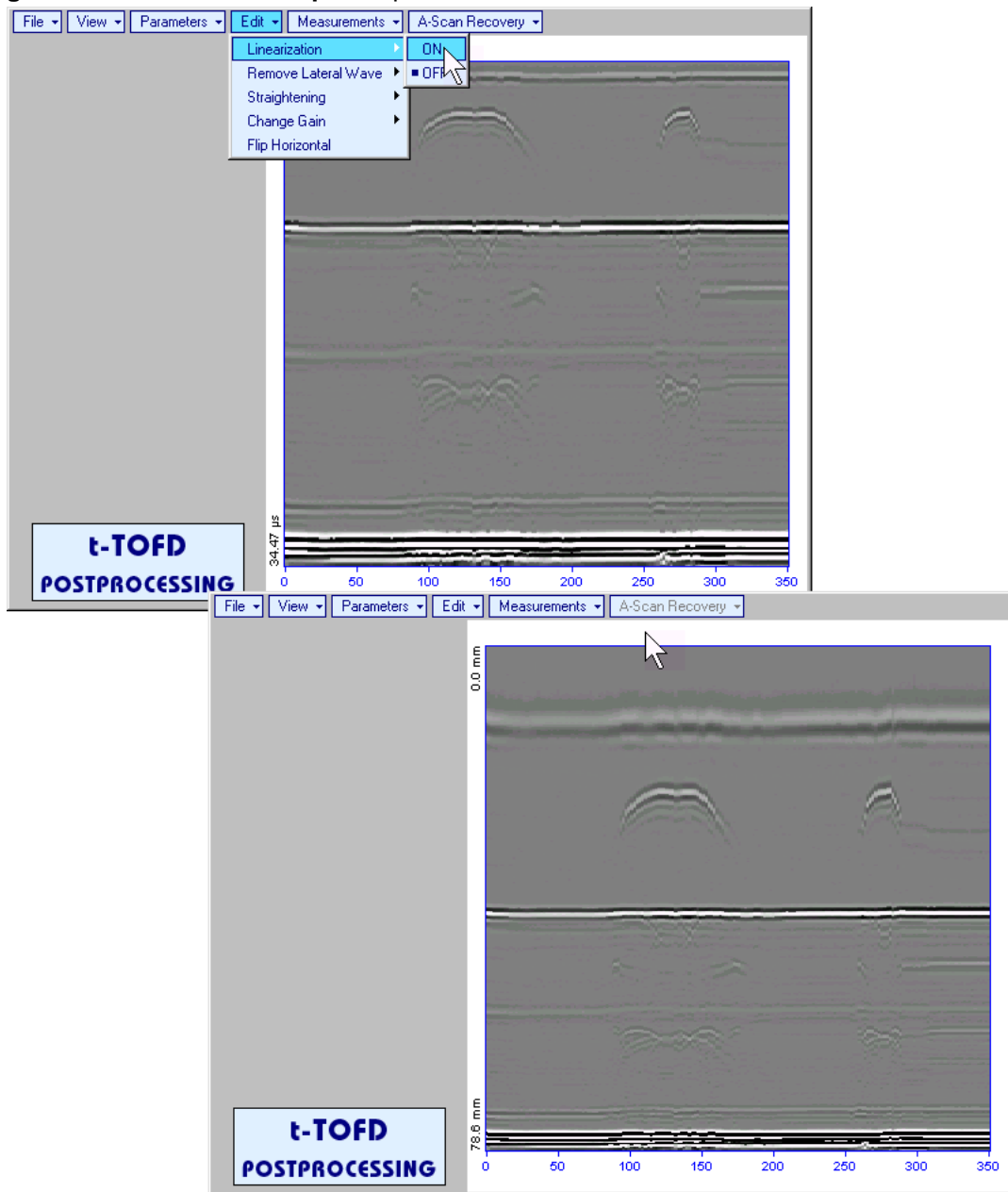

- **Edit→Linearization→ON** – recalculates depth for each point of **t-TOFD / TOFD** image and redraws it as **Longitudinal Coordinate – Depth** map





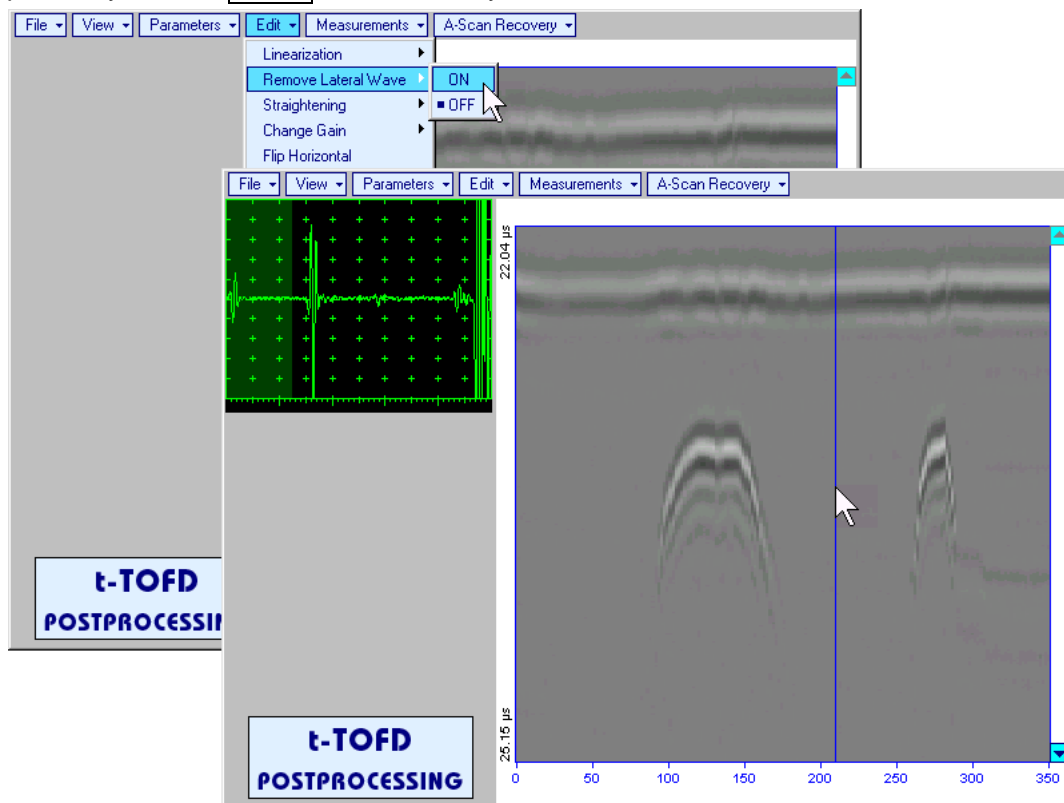

- **Edit→Linearization→OFF** – returns to original **t-TOFD / TOFD** image - **Longitudinal Coordinate – Time** map

- **Edit→Remove Lateral Wave→ON** – removes *rectangle segment* designated by an operator from **t-TOFD / TOFD** image. Most frequently this function is applied to lateral wave record, which is recorded continuously during line scanning and allows to better resolve defects located closely to scanning surface. Also this function may be applied to other signals continuously recorded during line scanning for example, backwall echo, mode conversion backwall echo, etc. - this allows to better resolve defects located closely to bottom surface. In addition to modifying of *rectangle segment* selected by an operator this function automatically straightens **t-TOFD / TOFD** image in order to compensate deviations caused by various factors during recording, for example, coupling instability, unevenness of scanning or bottom surface, etc. The described function is based on selecting *reference signal* and defining a *rectangle segment* on the **t-TOFD / TOFD** image. All signals corresponding to selected *rectangle segment* of **t-TOFD / TOFD** image are equalized by straightening function and then removed; appropriate changes do occur on **t-TOFD / TOFD** image above and under selected rectangle segment after its removal. Initially *cursor corresponding to A-Scan base line* is generated; it may be guided over **t-TOFD / TOFD** image

using either touch screen stylus or mouse or ,  on front panel keyboard or ,  on external keyboard – corresponding **A-Scan** is recovered synchronously according to *A-Scan base line cursor* position. To select reference **A-Scan** left mouse click or release touch screen stylus or press  on front panel keyboard or **Enter** on external keyboard





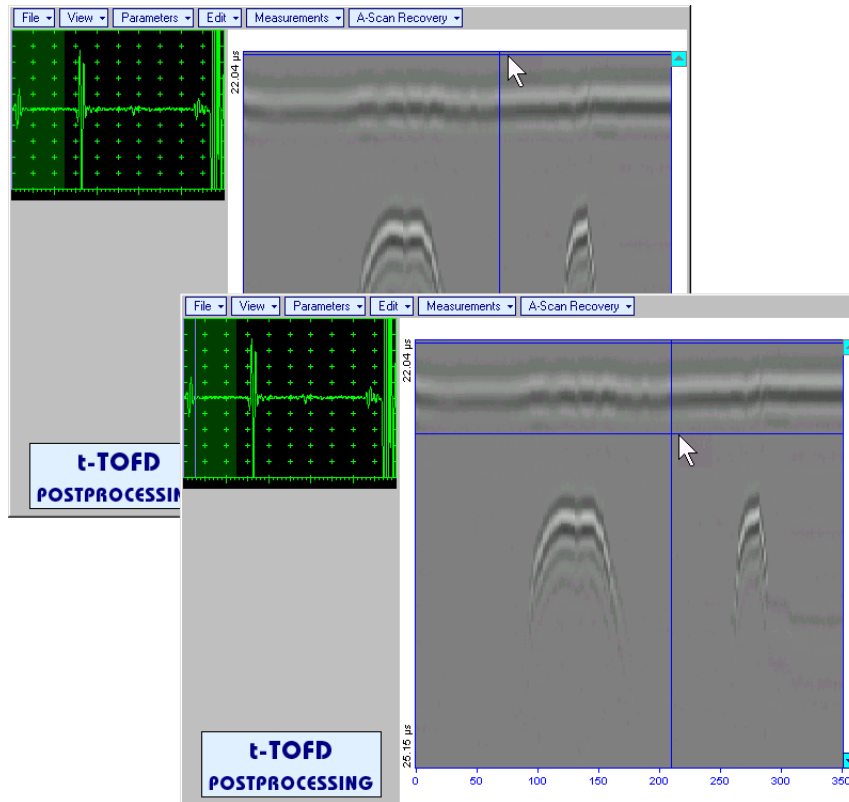

First horizontal cursor appears on the **t-TOFD / TOFD** image upon selecting reference **A-Scan**. It may be guided over **t-TOFD / TOFD** image using either touch screen stylus or mouse or  ,  on front panel keyboard or  ,  on external keyboard . To fix position of the first horizontal cursor and **designate start of reference signal** left mouse click or release touch screen stylus or press  on front panel keyboard or **Enter** on external keyboard . Second horizontal cursor appears upon fixing first one; it may be manipulated by the same way and allows **designating end of reference signal**



Horizontal cursors are accompanied with appropriate time cursors moving over reference A-Scan

First vertical cursor appears upon designating end of *reference signal*. Its length corresponds to duration of *reference signal* and it is located between first and second horizontal cursors. First vertical cursor may

be manipulated over **t-TOFD / TOFD** image using either touch screen stylus or mouse or  ,  on front panel keyboard or  ,  on external keyboard . To **designate first border of rectangle segment**

left mouse click or release touch screen stylus or press  on front panel keyboard or **Enter** on external keyboard . Second vertical cursor completing defining a rectangle appears upon fixing first one; it may be manipulated by the same way and allows to **designate second border of rectangle segment**

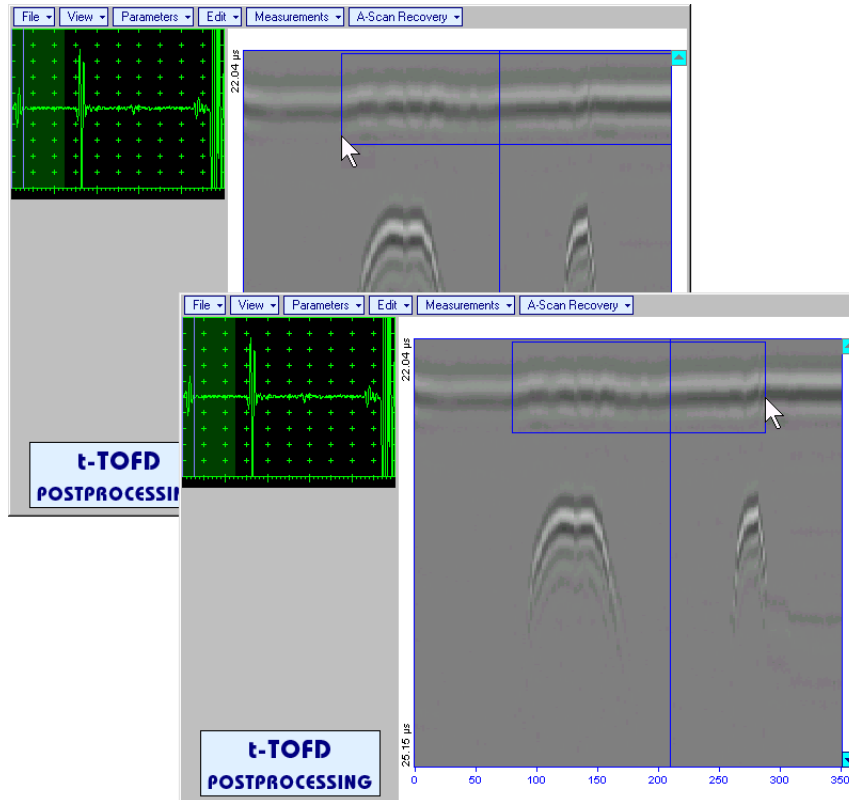



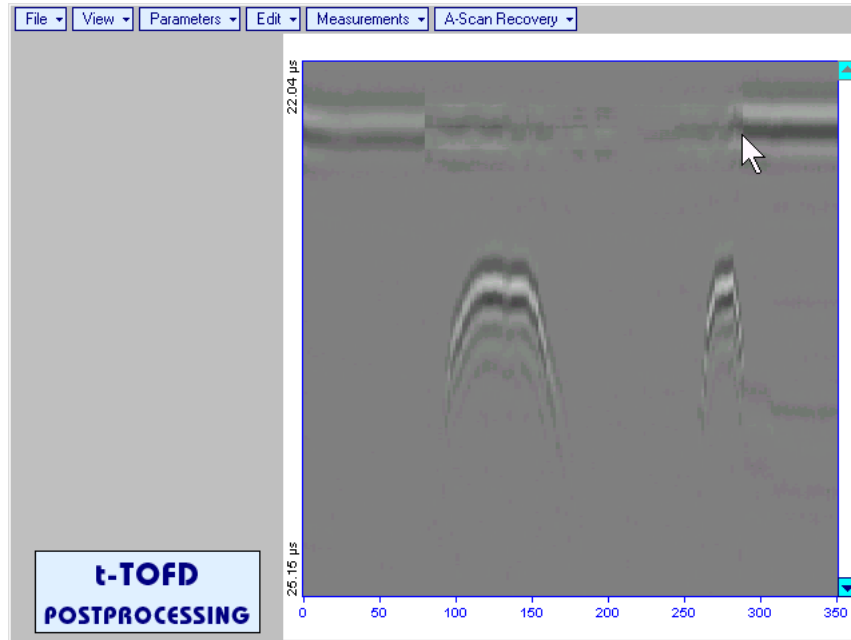

As a result:

- Signs of *reference signal* and corresponding signals in the selected *rectangle segment* are removed from **t-TOFD / TOFD** image
- **t-TOFD / TOFD** image is straightened above and under selected and modified *rectangle segment* to compensate deviations caused by various factors during recording, for example, coupling instability, unevenness of scanning or bottom surfaces, etc





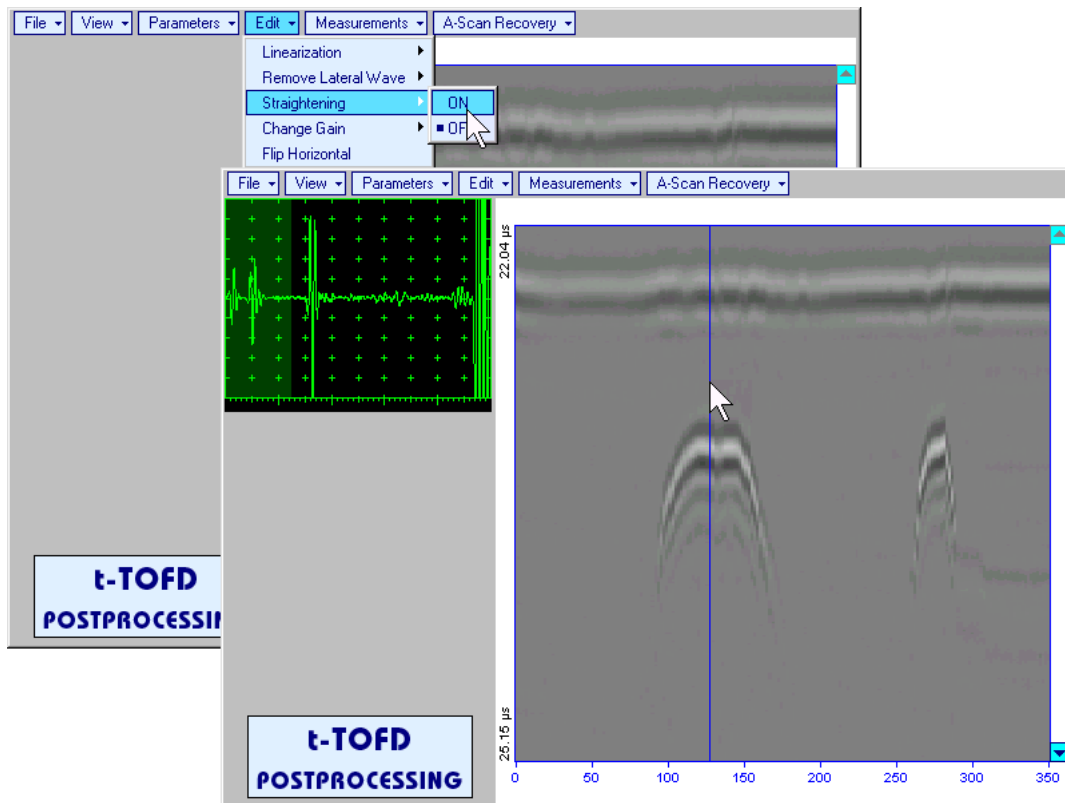

To interrupt function at any moment right mouse click or press  on front panel keyboard or **Esc** on external keyboard

- **Edit→Remove Lateral Wave→OFF** – negates modification of selected *rectangle segment* of **t-TOFD / TOFD** image

- Edit→Straightening→ON** – straightens **t-TOFD / TOFD** image in order to compensate deviations caused by various factors during recording, for example, coupling instability, unevenness of scanning or bottom surfaces, etc. It is based on selecting *reference signal* (either lateral wave, or backwall echo, or mode conversion backwall echo, etc) and defining a *rectangle segment* on the **t-TOFD / TOFD** image. All signals corresponding to selected *rectangle segment* of **t-TOFD / TOFD** image are equalized by straightening function and appropriate changes do occur on **t-TOFD / TOFD** image above and under modified *rectangle segment*. Initially *cursor corresponding to A-Scan base line* is generated; it may be guided over **t-TOFD / TOFD** image using either touch screen stylus or mouse or ,  on front panel keyboard or ,  on external keyboard – corresponding **A-Scan** is recovered synchronously according to *A-Scan base line cursor* position. To select reference **A-Scan** left mouse click or release touch screen stylus or press  on front panel keyboard or **Enter** on external keyboard





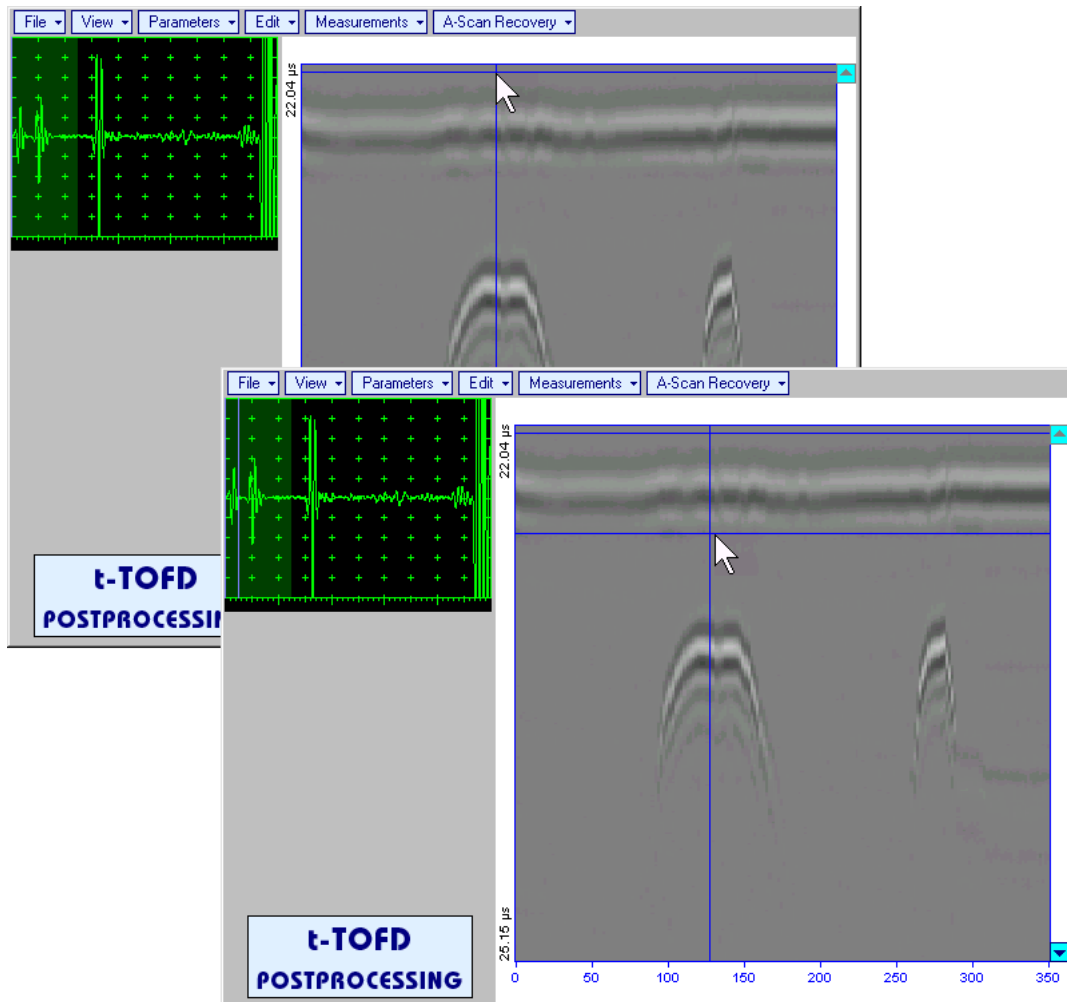

First horizontal cursor appears on the **t-TOFD / TOFD** image upon selecting reference **A-Scan**. It may be guided over **t-TOFD / TOFD** image using either touch screen stylus or mouse or ,  on front panel keyboard or ,  on external keyboard . To fix position of the first horizontal cursor and **designate start of reference signal** left mouse click or release touch screen stylus or press  on front panel keyboard or **Enter** on external keyboard . Second horizontal cursor appears upon fixing first one; it may be manipulated by the same way and allows to **designate end of reference signal**





First vertical cursor appears upon designating end of *reference signal*. Its length corresponds to duration of *reference signal* and it is located between first and second horizontal cursors. First vertical cursor may

be manipulated over **t-TOFD / TOFD** image using either touch screen stylus or mouse or  ,  on front panel keyboard or  ,  on external keyboard . To **designate first border of rectangle segment**

left mouse click or release touch screen stylus or press  on front panel keyboard or **Enter** on external keyboard . Second vertical cursor completing defining a rectangle appears upon fixing first one; it may be manipulated by the same way and allows to **designate second border of rectangle segment**

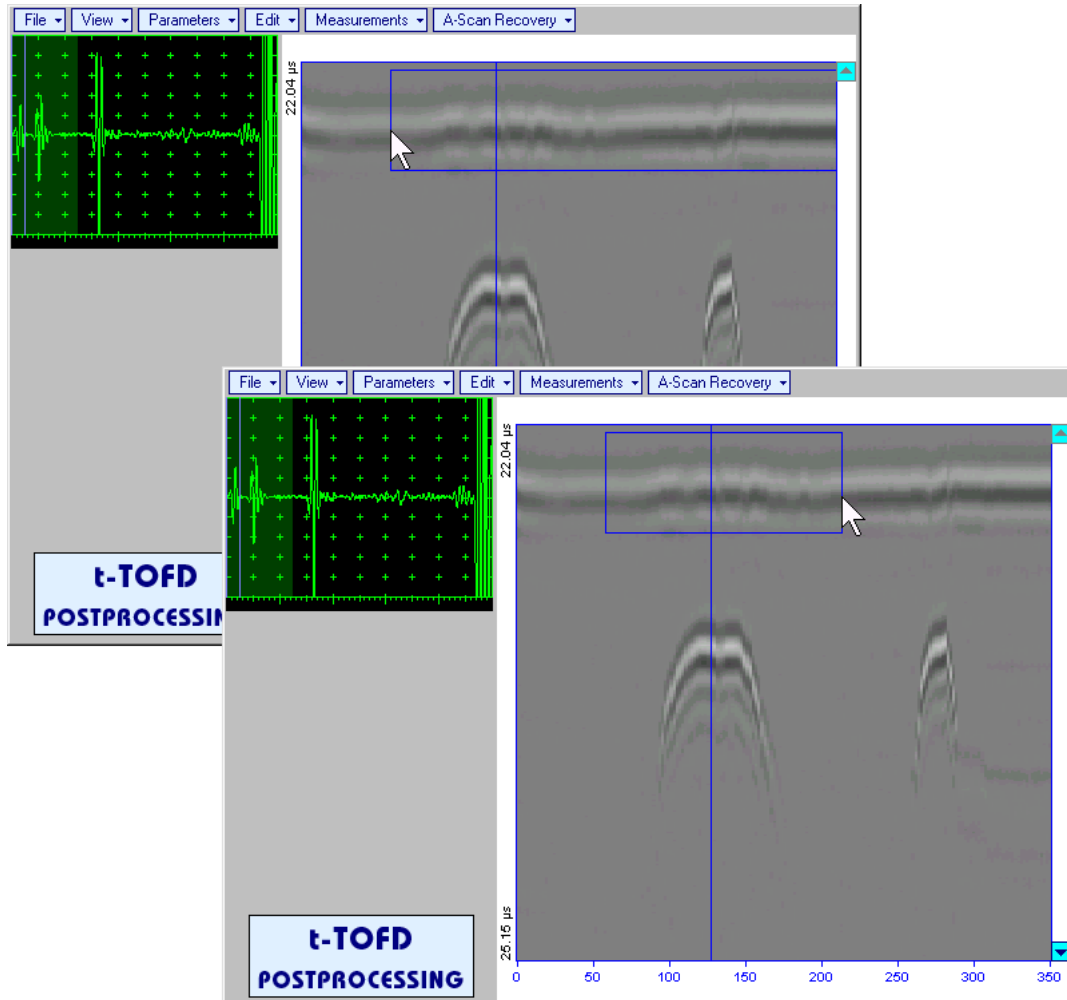



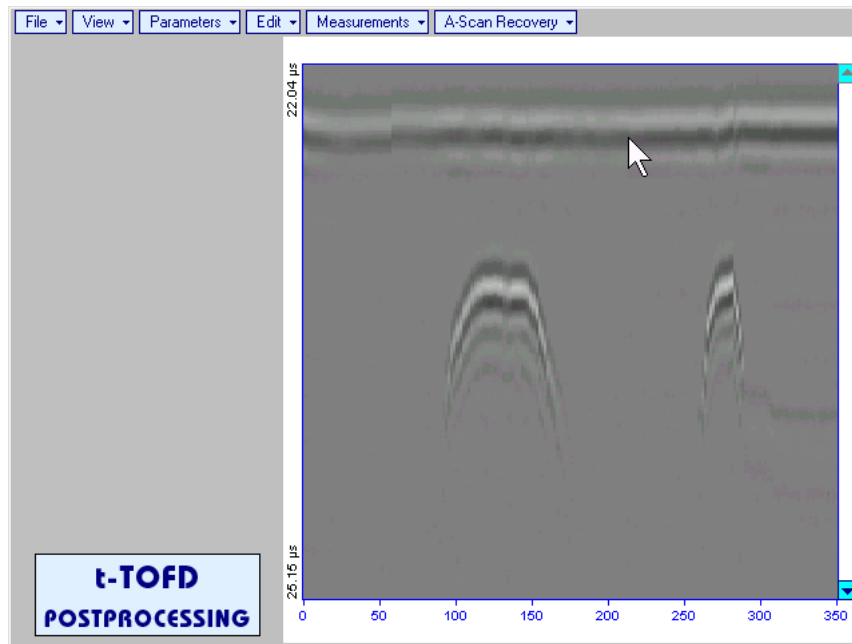







As a result **t-TOFD / TOFD** image is straightened in, above, and under selected *rectangle segment* to compensate deviations caused by various factors during recording, for example, coupling instability, unevenness of scanning or bottom surfaces, etc





To interrupt function at any moment right mouse click or press  on front panel keyboard or **Esc** on external keyboard

- **Edit→Straightening→OFF** – negates modification of selected *rectangle segment* of **t-TOFD / TOFD** image

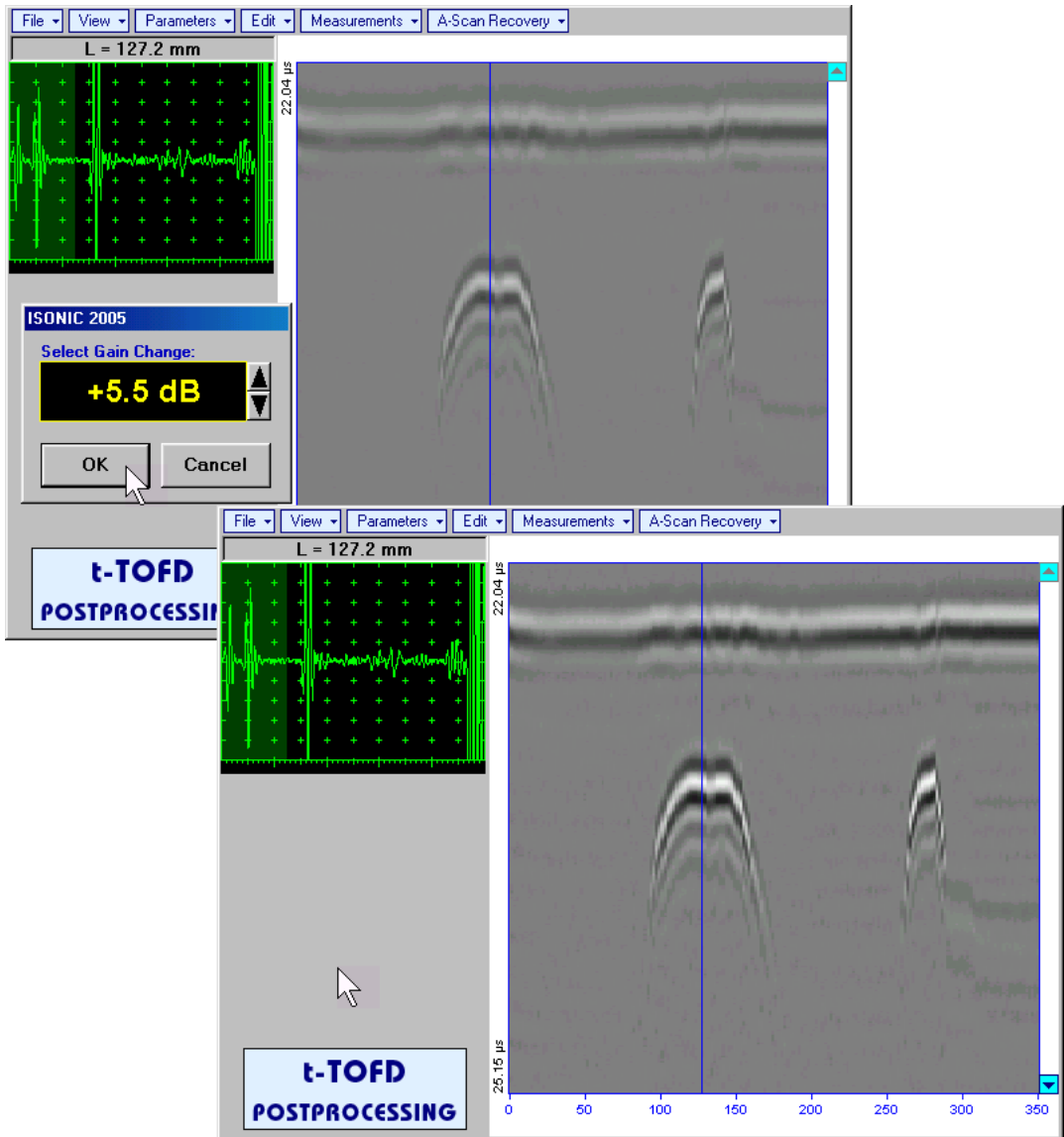
- Edit→Change Gain→ON** – generates *cursor corresponding to A-Scan base line* that may be guided over **t-TOFD / TOFD** image using either touch screen stylus or mouse or ,  on front panel keyboard or ,  on external keyboard – corresponding **A-Scan** is recovered synchronously according to *A-Scan base line cursor position*. To select reference **A-Scan** release touch screen stylus or left mouse click or press  on front panel keyboard or **Enter** on external keyboard – this generates subwindow allowing off-line re-adjusting of **Gain** for all **A-Scans** captured during **t-TOFD / TOFD** recording in  $\pm 6\text{dB}$  range with  $\pm 0.1\text{ dB}$  increments through clicking or pressing and holding on  or pressing ,  on front panel keyboard or ,  on external keyboard





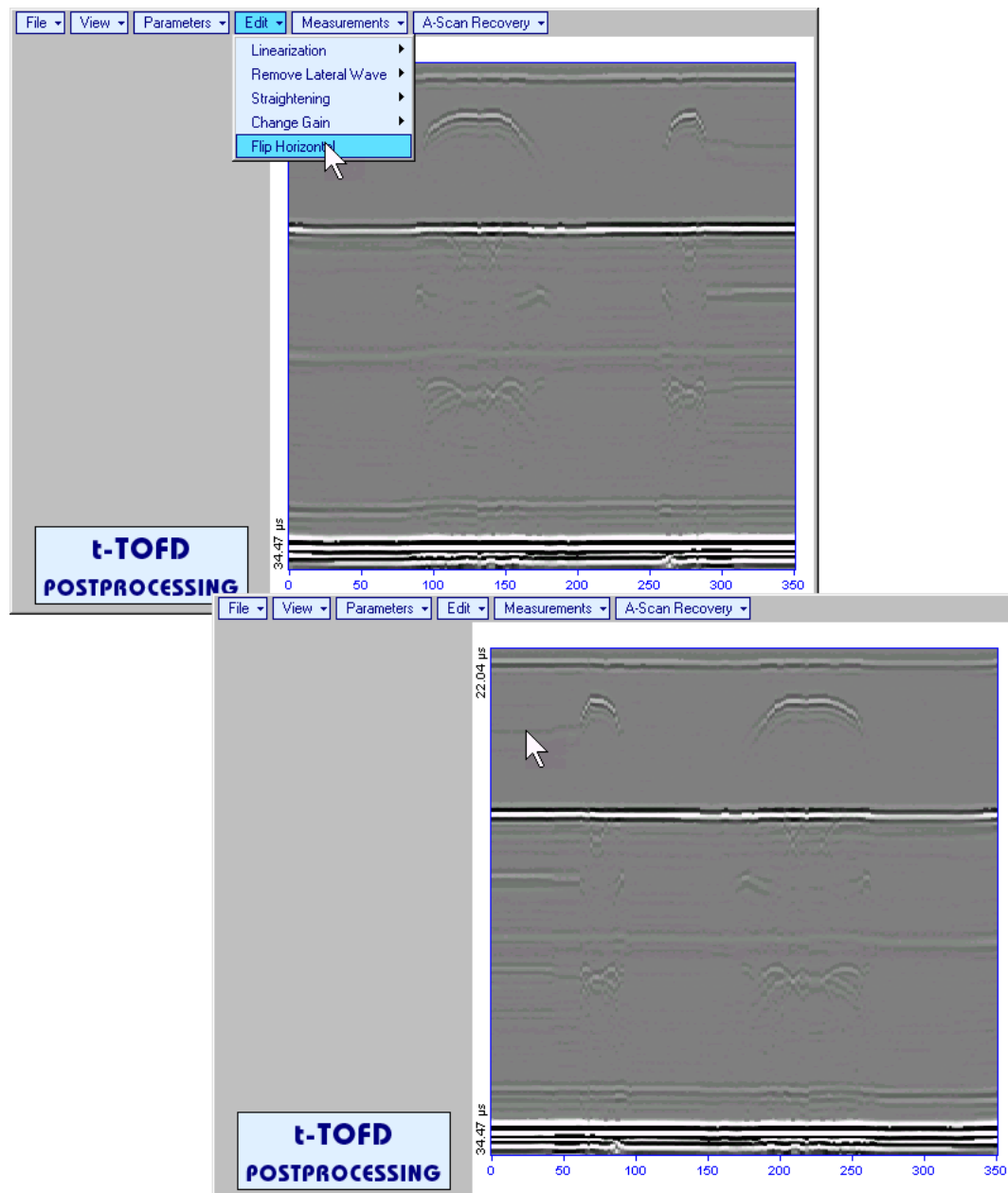

During **Gain** re-adjusting reference **A-Scan** is modified accordingly. Upon completing re-adjusting **Gain** click on  or press  on front panel keyboard or **Enter** on external keyboard – this applies new **Gain** value to all captured **A-Scans** and redraws **t-TOFD / TOFD** image accordingly

To interrupt re-adjusting of **Gain** click on **Cancel** or press  on front panel keyboard or **Esc** on external keyboard





- **Edit→Change Gain→OFF** – negates **Gain** re-adjustment and returns to originally recorded **t-TOFD / TOFD** image and original **Gain** setting
- **Edit→Flip Horizontal** – reorders **A-Scans** captured during **t-TOFD / TOFD** recording in reverse succession and redraws **t-TOFD / TOFD** image accordingly. This service function may be useful for merging scans of neighboring sections of an object, which were scanned in opposite direction due to access conditions, etc

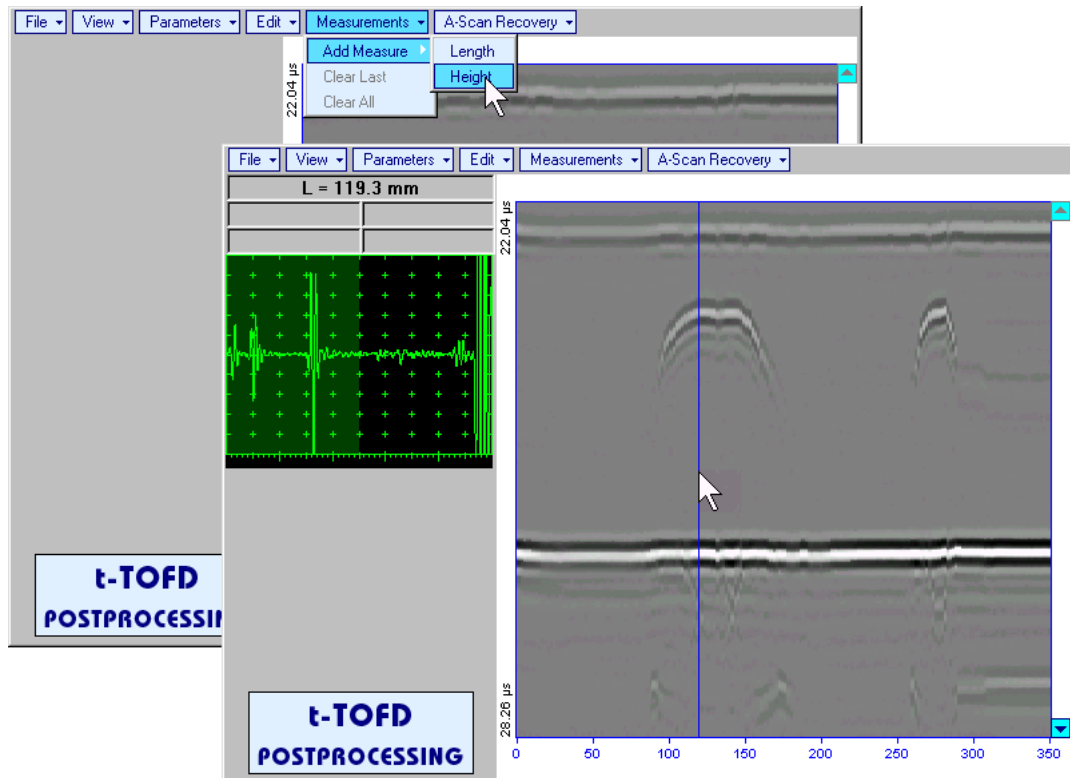

Applying of **Flip Horizontal** function empties *postprocessing session memory stack*

- Measurements→Add Measure→Height** – generates *cursor corresponding to A-Scan base line* that may be guided over **t-TOFD / TOFD** image using either touch screen stylus or mouse or  ,  on front panel keyboard or  ,  on external keyboard – corresponding **A-Scan** is recovered synchronously according to *A-Scan base line cursor* position. Indication of starting position of cursor (**L**) corresponding to the position of **TOFD** probes pair accompanies recovered **A-Scan**. *A-Scan base line cursor* to be positioned over defect image to minimize displacement of defect's signal with regard to starting point of **A-Scan**. To fix position of *A-Scan base line cursor* release touch screen stylus or left mouse click or press  on front panel keyboard or **Enter** on external keyboard . Indication of starting position of cursor (**L**) corresponding to probe's center accompanies recovered **A-Scan**



First horizontal cursor appears upon fixing *A-Scan base line cursor*, it may be guided over **t-TOFD** / **TOFD** image using either touch screen stylus or mouse or ,  on front panel keyboard or ,  on external keyboard . First horizontal cursor is accompanied with first *time cursor* synchronously moving over reference **A-Scan**. Coordinate of the first horizontal cursor - *depth* (**H**) and corresponding time of flight (**t**) are indicated synchronously. To fix position of the first horizontal cursor left mouse click or  on front panel keyboard or **Enter** on external keyboard . Second horizontal cursor appears upon fixing first one, it may be manipulated by the same way. Second horizontal cursor is accompanied with second *time cursor* synchronously moving over reference **A-Scan**. Coordinate of the second horizontal cursor measured relatively to position of first horizontal cursor (**dH**) and corresponding delay of second *time cursor* relatively to first *time cursor* (**dt**) are indicated synchronously. Provided the horizontal cursors are placed properly:

- **H** represents defect depth
- **t** represents time of flight for first diffracted signal
- **dH** represents defect's height
- **dt** represents delay of second diffracted signal relatively first diffracted signal

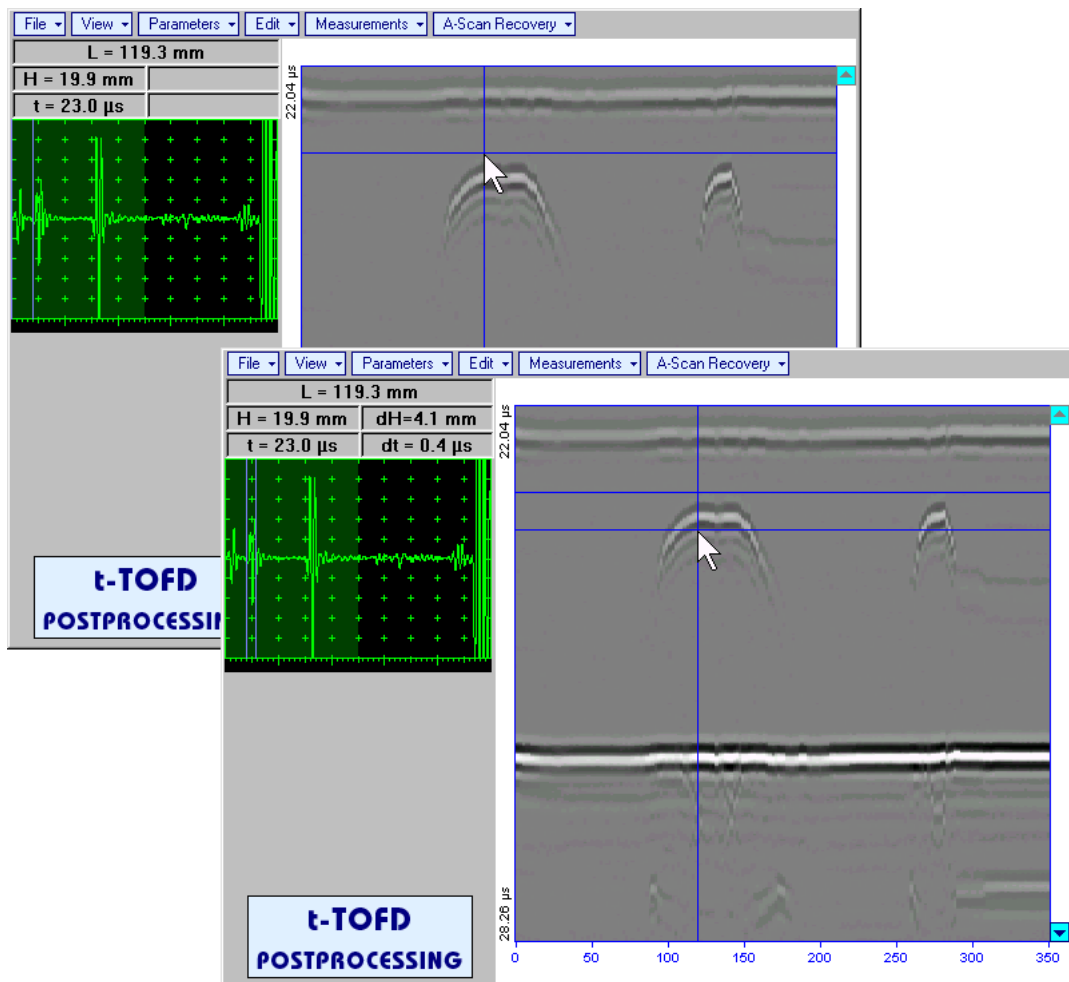

To interrupt width measurement procedure at any moment right mouse click or press  on front panel keyboard or **Esc** on external keyboard

Vertical **depth/height measurement mark** appears on the **t-TOFD / TOFD** image upon fixing position of second horizontal cursor

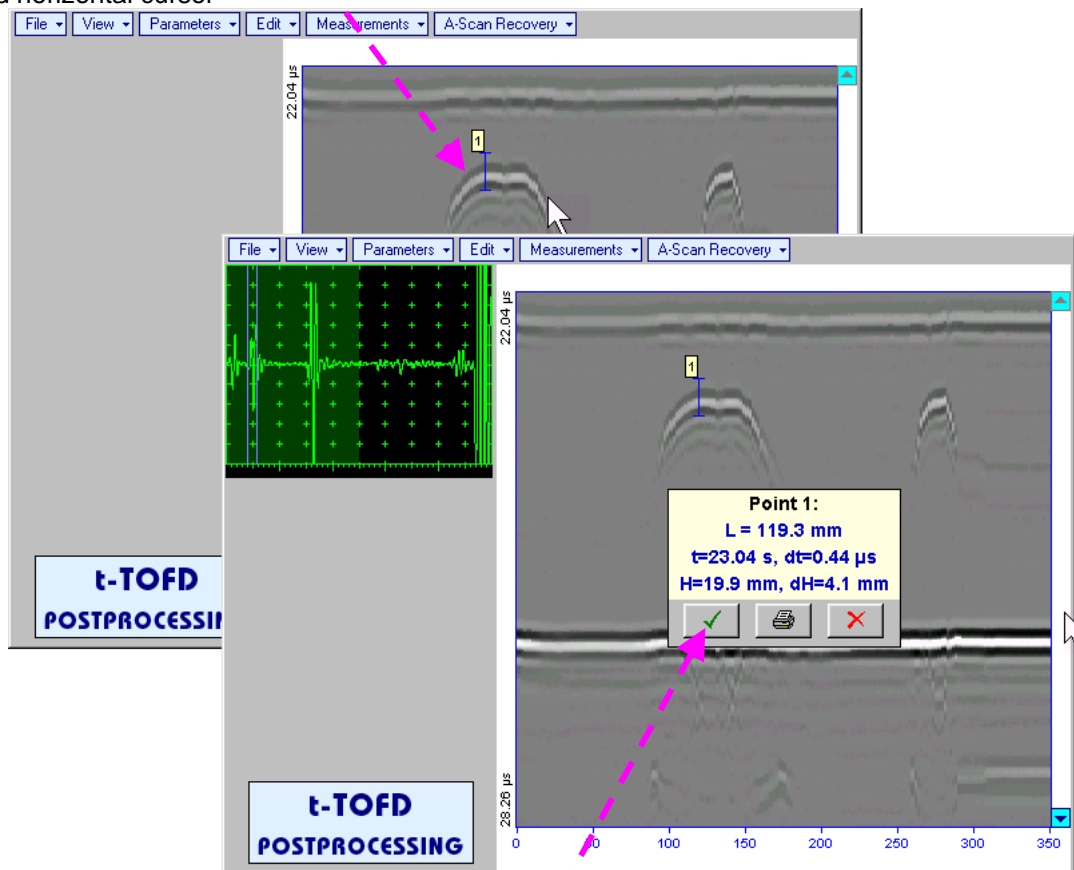

Depth measurement results may be recalled into **subwindow** accompanied with corresponding **A-Scan** through double click on the *depth measurement mark*









In the subwindow appearing:

- **L** is coordinate of *depth measurement mark* along scanning line
- **H** represents defect depth
- **t** represents time of flight for first diffracted signal
- **dH** represents defect's height
- **dt** represents delay of second diffracted signal relatively first diffracted signal

Clicking on  will print current screen snapshot accompanied with *depth measurement mark* data

Clicking on  will hide subwindow with *depth measurement mark* data

Clicking on  will hide subwindow with *depth measurement mark* data and erase corresponding *depth measurement mark*

- Measurements→Add Measure→Length** – generates *left parabolic cursor* that may be guided over **t-TOFD / TOFD** image using either touch screen stylus or mouse or , , ,  on front panel keyboard or , , ,  on external keyboard . **A-Scan**, corresponding to coordinate (**L**) of tip of *left parabolic cursor* along scanning line is recovered synchronously. *Left parabolic cursor* to be placed over left defect's end providing shape matching. To fix position of *left parabolic cursor* left mouse click or release touch screen stylus or press  on front panel keyboard or **Enter** on external keyboard

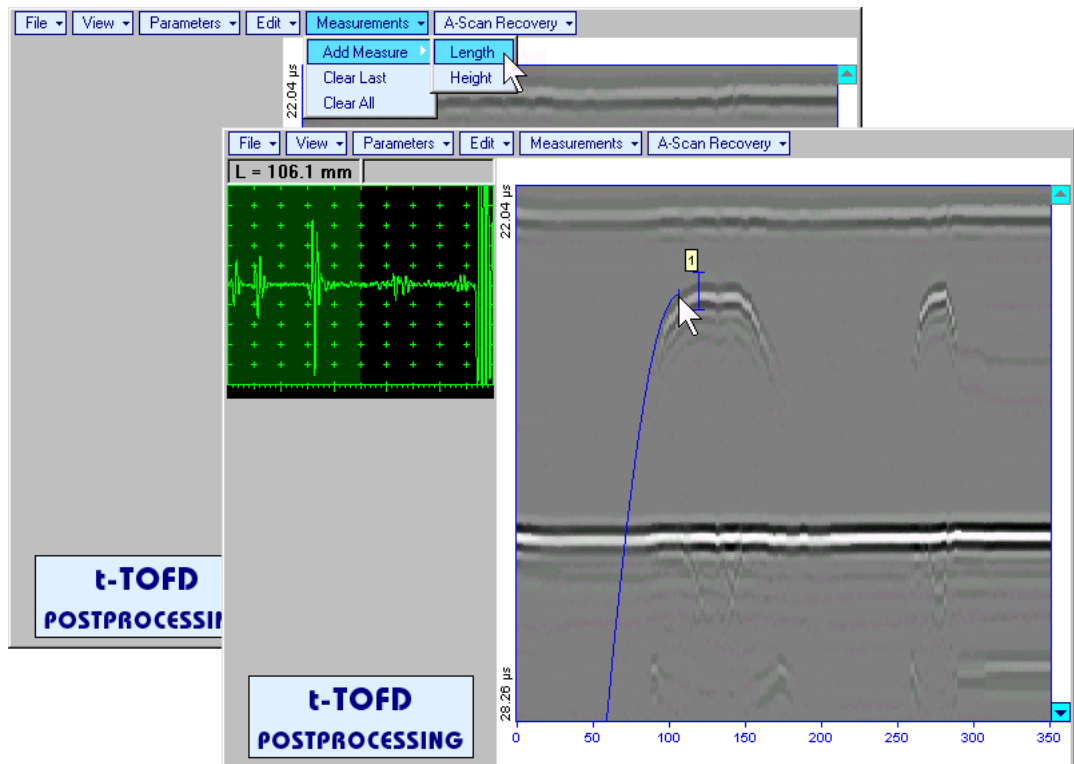



*Right parabolic cursor* appears upon fixing *left parabolic cursor*. It may be manipulated by the same way and must be placed over right defect's end providing shape matching. Coordinate of *right parabolic cursor* along **t-TOFD / TOFD** image measured relatively to position of *left parabolic cursor* (**dL**) is indicated synchronously, it represents length of defect area provided that both parabolic cursors are placed properly

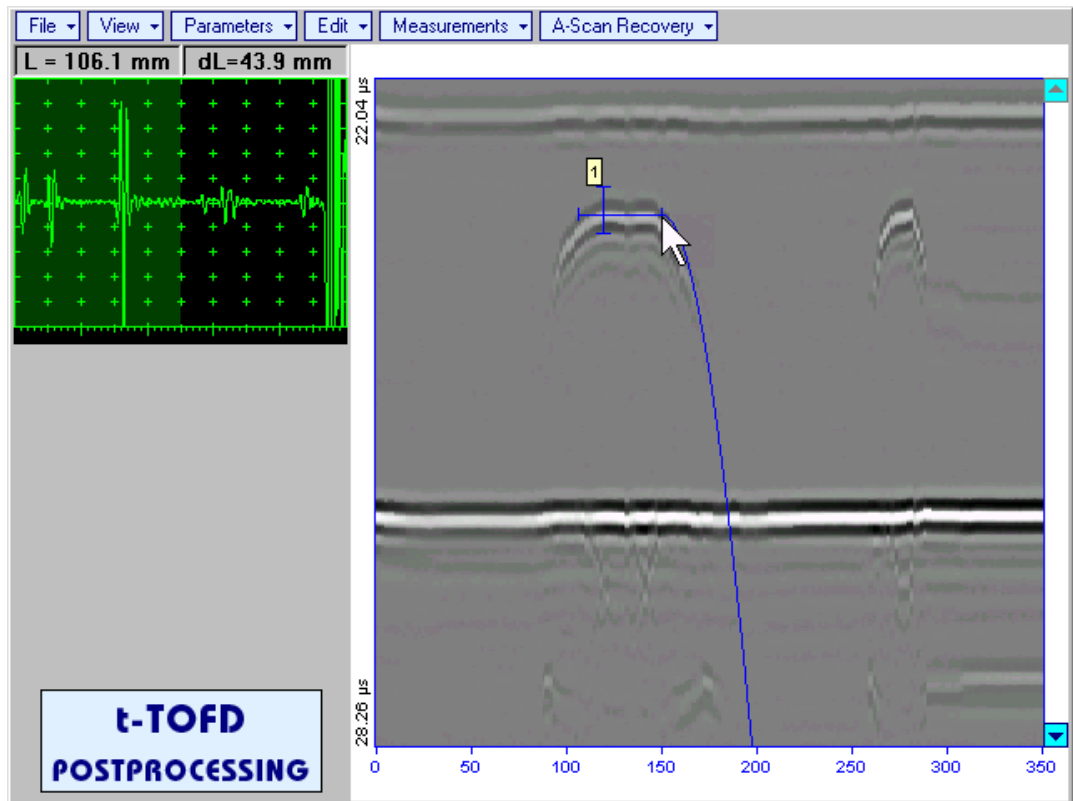

To interrupt length measurement procedure at any moment right mouse click or press  on front panel keyboard or **Esc** on external keyboard

Horizontal **length measurement mark** appears on **t-TOFD / TOFD** image upon fixing position of *right parabolic cursor*

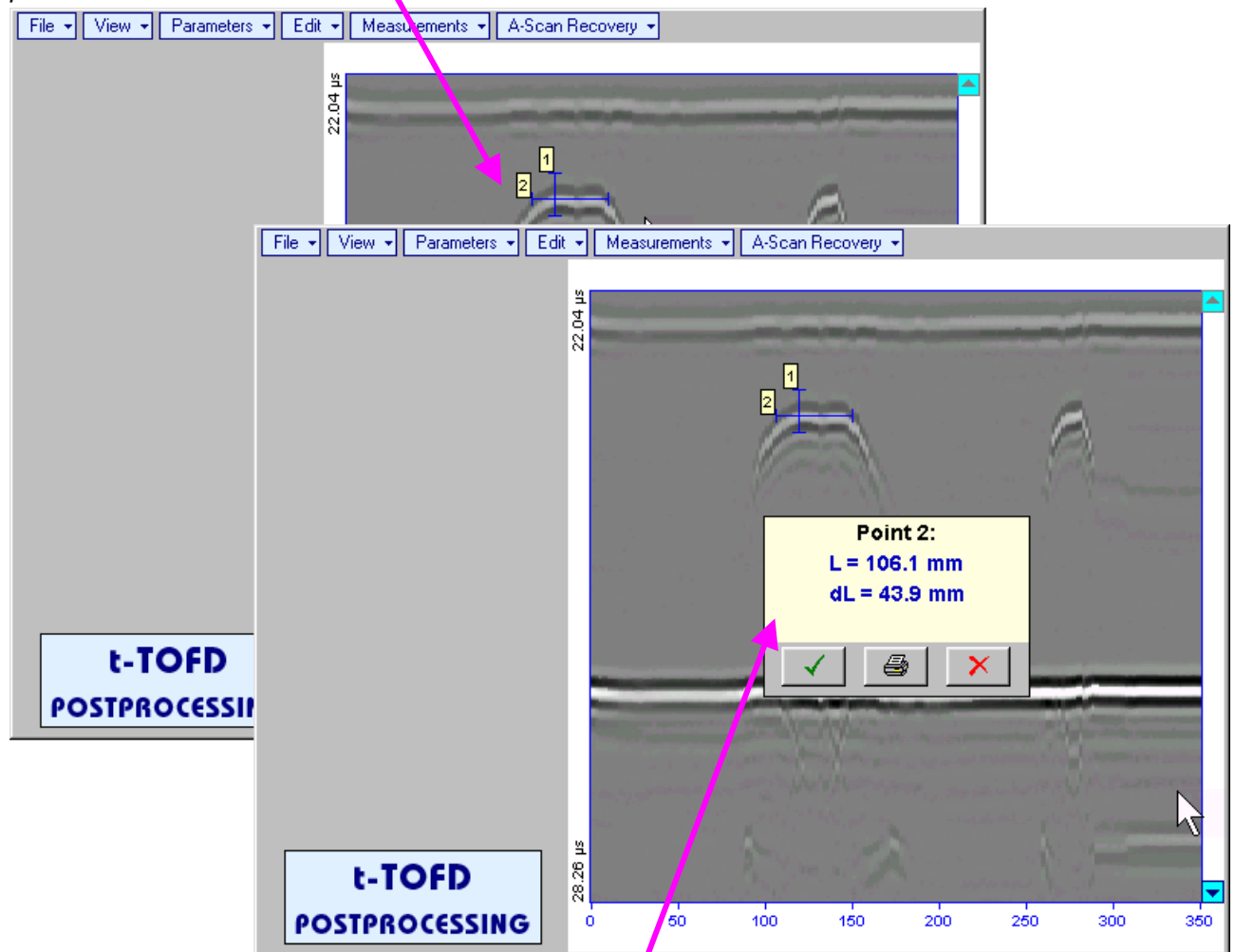



Length measurement results may be recalled into **subwindow** through double click on the *length measurement mark*

In the subwindow appearing:

- **L** is coordinate of left end of the *length measurement mark*
- **dL** is length of defect area covered by *length measurement mark*
- **H** is distance between scanning line and *length measurement mark*

Clicking on  will print current screen snapshot accompanied with *length measurement mark* data



Clicking on  will hide subwindow with *length measurement mark* data

Clicking on  will hide subwindow with *length measurement mark* data and erase corresponding *length measurement mark*

- **Measurements→Clear Last** – erases last *length* or *depth/height measurement mark* placed on the **t-t-TOFD / TOFD** image
- **Measurements→Clear All** – erases all *length* and *depth/height measurement marks* placed on the **t-t-TOFD / TOFD** image

## 6.6. CB-Scan horizontal plane-view imaging and recording of defects for shear, surface, and guided wave inspection – t-FLOORMAP L or FLOORMAP L

### 6.6.1. Setup Pulser Receiver for t-FLOORMAP L and FLOORMAP L

UDS 3-5 Pulser Receiver window – main operating surface – appears on ISONIC 2007 screen upon clicking on  or . The settings as below to be provided

#### 6.6.1.1. Angle Beam Inspection – Shear and Longitudinal Waves

| #  | Parameter or Mode  | Submenu  | Required Settings  | Note   |
|----|--|----------|--|--|
| 1  | Gain   | BASICS   | Gain setting to be performed according to inspection procedure providing required echo heights from defects to be detected |  |
| 2  | DAC/TCG  | DAC/TCG  | DAC/TCG settings to meet requirements of inspection procedure  |  |
| 3  | Pulser Mode  | PULSER   | Dual for dual element probes<br>Single for single element probes   |  |
| 4  | Tuning, Pulse Width, Firing Level, Damping                   | PULSER   | Tuning, Pulse Width, Firing Level, and Damping settings to provide optimal signal to noise ratio                           | To synchronize with Gain setting procedure   |
| 5  | Filter, Frequency  | RECEIVER | Filter and Frequency settings to match with probe's frequency  | To synchronize with Gain setting procedure   |
| 6  | Display  | RECEIVER | Display setting may be either Full, RF, PosHalf, or NegHalf  | The same Display mode to be used for both Probe Delay determining and t-FLOORMAP L / FLOORMAP L Recording  |
| 7  | USVelocity   | BASICS   | USVelocity setting to be equal to actual value of ultrasound velocity in the object under test                             |  |
| 8  | Probe Delay  | MEASURE  | Probe Delay setting to be equal to actual probe delay  | For shear wave / longitudinal wave angle beam inspection probe delay may be determined according to paragraph 5.2.13.5, 5.2.13.6 or 5.2.13.8 of this Operating Manual or similarly |
| 9  | Display Delay  | BASICS   | Display Delay setting to be equal to actual probe delay  | Recommend Display Delay = Probe Delay  |
| 10 | Angle  | MEASURE  | Angle setting to be equal to actual probe angle  |  |
| 11 | Settings for other parameters and modes have no significance |          |  |  |

Click on  or press  on front panel keyboard or **F8** on external keyboard upon completing

### 6.6.1.2. Guided, Surface, Creeping, and Head Wave Inspection

| #  | Parameter or Mode  | Submenu  | Required Settings  | Note  |
|----|--|----------|--|---|
| 1  | Gain   | BASICS   | Gain setting to be performed according to inspection procedure providing required echo heights from defects to be detected | For guided / surface / creeping / head wave inspection Gain setting may be implemented according to paragraph 6.6.1.4 of this Operating Manual or similarly       |
| 2  | DAC/TCG  | DAC/TCG  | DAC/TCG settings to meet requirements of inspection procedure  | For guided / surface / creeping / head wave inspection DAC may be created according to paragraph 6.6.1.4 of this Operating Manual or similarly                    |
| 3  | Pulser Mode  | PULSER   | Dual for dual element probes<br>Single for single element probes   |   |
| 4  | Tuning, Pulse Width, Firing Level, Damping                   | PULSER   | Tuning, Pulse Width, Firing Level, and Damping settings to provide optimal signal to noise ratio                           | To synchronize with Gain setting procedure  |
| 5  | Filter, Frequency  | RECEIVER | Filter and Frequency settings to match with probe's frequency  | To synchronize with Gain setting procedure  |
| 6  | Display  | RECEIVER | Display setting may be either Full, RF, PosHalf, or NegHalf  | The same Display mode to be used for both Probe Delay determining and t-FLOORMAP L / FLOORMAP L Recording   |
| 7  | USVelocity   | BASICS   | USVelocity setting to be equal to actual value of ultrasound velocity in the object under test                             | For guided / surface / creeping / head wave inspection ultrasound velocity may be determined according to paragraph 6.6.1.3 of this Operating Manual or similarly |
| 8  | Probe Delay  | MEASURE  | Probe Delay setting to be equal to actual probe delay  | For guided / surface / creeping / head wave inspection probe delay may be determined according to paragraph 6.6.1.3 of this Operating Manual or similarly         |
| 9  | Display Delay  | BASICS   | Display Delay setting to be equal to actual probe delay  | Recommend Display Delay = Probe Delay   |
| 10 | Angle  | MEASURE  | 90°  |   |
| 11 | Settings for other parameters and modes have no significance |          |  |   |

Click on  or press  on front panel keyboard or **F8** on external keyboard upon completing

### 6.6.1.3. Determining Probe Delay and Ultrasound Velocity for Guided / Surface / Creeping / Head Wave Inspection

The following procedure is recommended for finding **Probe Delay** and **US Velocity** settings necessary to perform guided wave inspection:

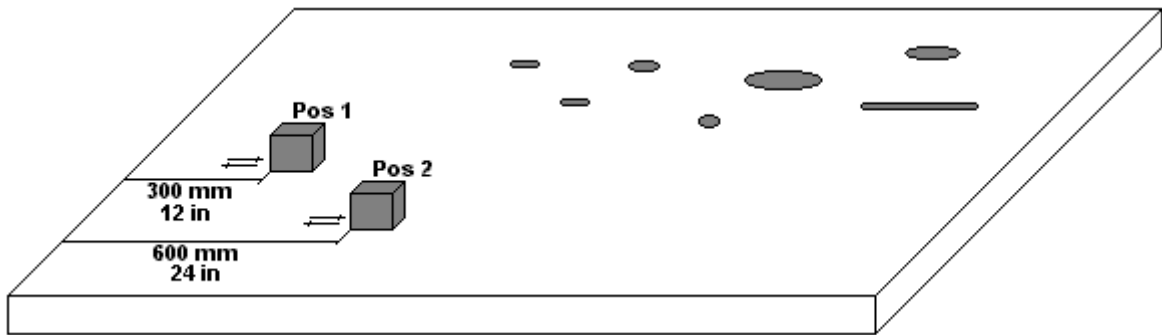

- (a) In the **UDS 3-5 Pulser Receiver** window – submenu **BASICS** setup **Range = 750 mm** (or **30 in**)
- (b) In the **UDS 3-5 Pulser Receiver** window – submenu **BASICS** setup **US Velocity = 3000 m/s** (or **120 in/ms**)
- (c) Place guided wave probe into position **Pos 1** on a reference plate providing **300 mm** (or **12 in**) distance between probe's frontal surface and plate end
- (d) Tune **Gain** to provide plate end echo reaching **80-90%** of **A-Scan** screen height
- (e) Tune **Display Delay** (submenu **BASICS**) to provide rising edge of plate end echo matching with **40%** grid on horizontal **A-Scan** screen scale
- (f) Place guided wave probe into position **Pos 2** on a reference plate providing **600 mm** (or **24 in**) distance between probe's frontal surface and plate end
- (g) Tune the **US Velocity** (submenu **BASICS**) to provide rising edge of plate end echo matching with **80%** grid on horizontal **A-Scan** screen scale
- (h) Place again guided wave probe into position **Pos 1** on a reference plate providing **300 mm** (or **12 in**) distance between probe's frontal surface and plate end
- (i) Repeat steps (e) through (h) as above until further tuning will not be necessary, i.e. placement of guided wave probe into positions **Pos 1** and **Pos 2** causes rising edge of plate end echo appearing at **40%** and **80%** on horizontal **A-Scan** screen scale correspondingly. Since that **Display Delay** and **US Velocity** settings are proper
- (j) In the submenu **MEASURE** provide **Probe Delay = Display Delay** whereas **Display Delay** value to be found according to above steps (a) through (i)

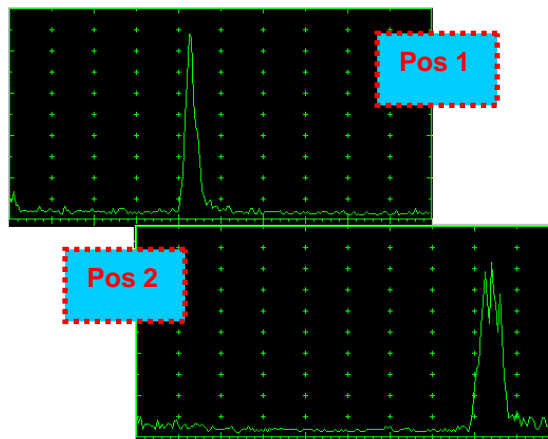

- Probe Delay** and **US Velocity** for surface / creeping / head wave inspection may be found similarly
- Automatic Calibration (AUTOCAL) procedure according to paragraph 5.2.13.8 of this Operating Manual is also applicable

#### **6.6.1.4. Setting Gain and DAC for Guided / Surface / Creeping / Head Wave Inspection**

For setting up **Gain** and **DAC** a reference plate containing artificial defects is required; said reference plate must have acoustical properties (longitudinal and shear wave propagation velocity, attenuation) thickness and curvature differing from the same properties of the plate to be inspected in not more than  $\pm 10\%$ .

**Gain** setting to be performed through providing sure detection of artificial defect from selected distances according to required inspection range

Optional **DAC** setting for guided wave inspection to be performed as below:

Place guided wave probe into position on reference plate providing receiving of an echo from a reflector

- (a) Place guided wave probe into position on reference plate providing receiving of an echo from a reflector passing minimal travel distance
- (b) Follow instructions of paragraph 5.2.10 of this Operating Manual to record first DAC echo
- (c) Move the probe away from the reflector keeping it's echo maximized for each new DAC echo recording paragraph 5.2.10 of this Operating Manual

## 6.6.2. t-FLOORMAP L and FLOORMAP L – Implementation

### 6.6.2.1. t-FLOORMAP L – Prior to Scanning

t-FLOORMAP L control panel is shown below

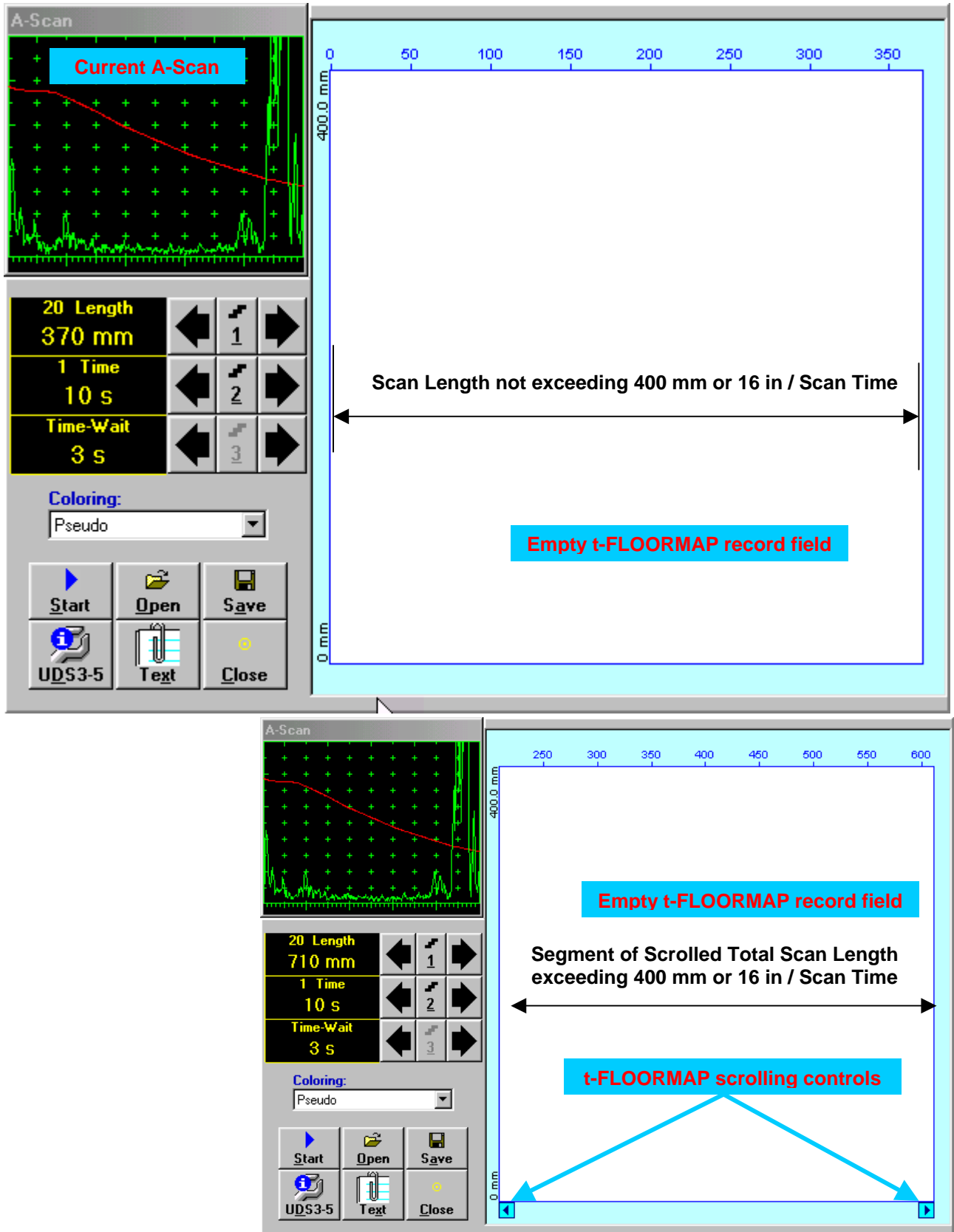

## Scan Length and Scan Time

**Length** represents length of section of test object to be displayed, over which probe will be scanning during recording period. **Time** (Scan Time) is the duration of recording period

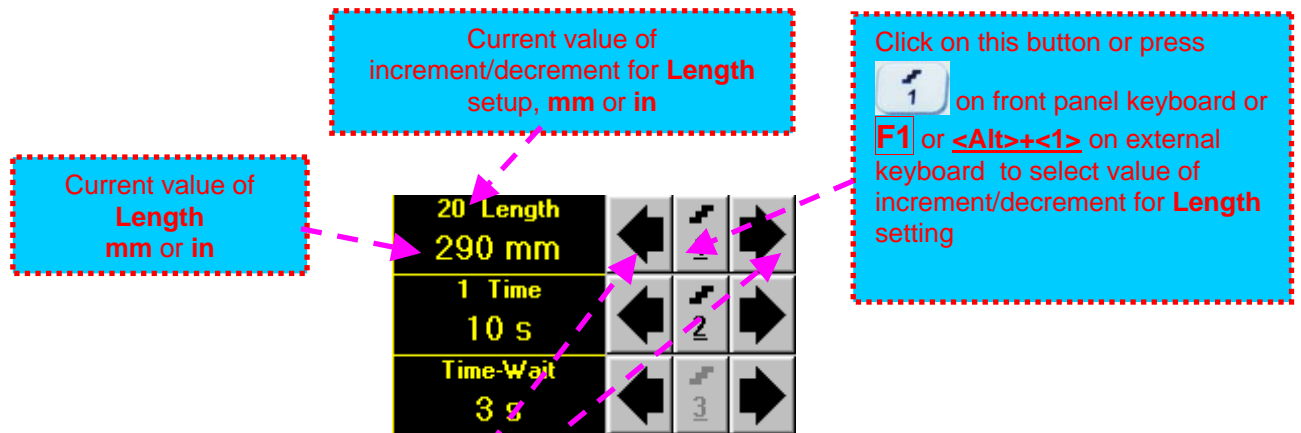

To control **Length** the following manipulations are applicable:

- **Mouse / Touch Screen**

- Click on corresponding button

- **Keyboard**

- Press on front panel keyboard or **F1** on external keyboard ⇒ **Length** fore color changes to white - then use , , , on front panel keyboard or , , , on external keyboard

- **Combined**

- Click on **Length** ⇒ **Length** fore color changes to white - then use , , , on front panel keyboard or , , , on external keyboard



The value of **Length** is adjustable between 50 and 1000 **mm** or 2 and 40 **in**



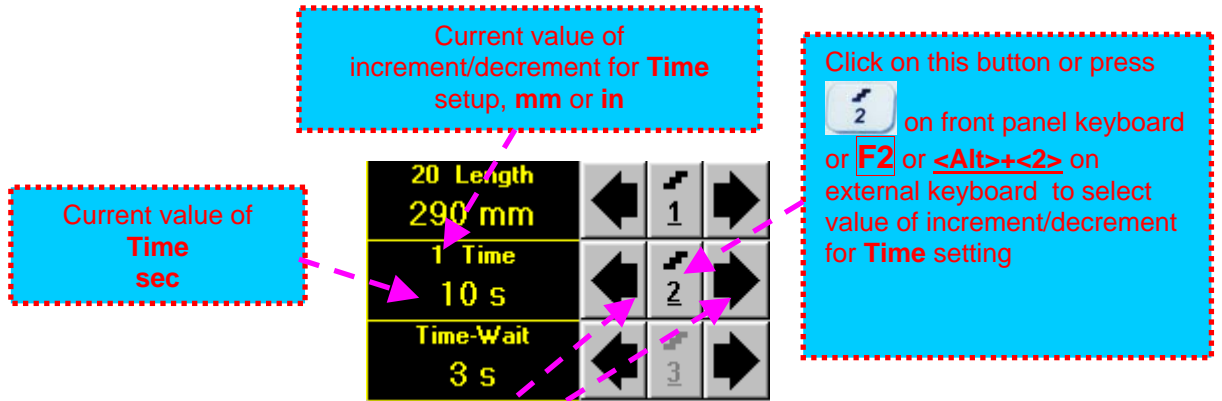

To control **Time** the following manipulations are applicable:

- **Mouse / Touch Screen**

- Click on corresponding button

- **Keyboard**

- Press on front panel keyboard or **F2** on external keyboard ⇒ **Time** fore color changes to white - then use , , , on front panel keyboard or , , , on external keyboard

- **Combined**

- Click on **Time** ⇒ **Time** fore color changes to white - then use , , , on front panel keyboard or , , , on external keyboard



The value of **Time** is adjustable between 5 and 60 **sec**

## Time-Wait

**Time-Wait** is waiting time for intermissions predessing **t-TOFD** recording, which starts unconditionally upon **Time-Wait** period is over

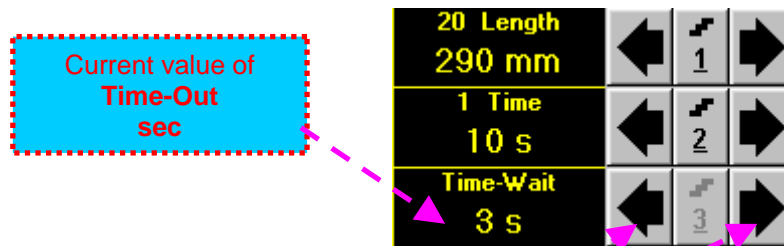

To control **Time-Wait** the following manipulations are applicable:









- **Mouse / Touch Screen**

- Click on corresponding **button**

- **Keyboard**

- Press  on front panel keyboard or **F3** on external keyboard ⇒ **Time-Wait** fore color changes to white - then use , , ,  on front panel keyboard or , , ,  on external keyboard

- **Combined**

- Click on **Time-Wait** ⇒ **Time-Wait** fore color changes to white - then use , , ,  on front panel keyboard or , , ,  on external keyboard



The value of **Time-Wait** is adjustable between 0 and 15 sec

## t-FLOORMAP L Record Palette

There are four palettes available through – select **through**





## Insert Text Note





Refer to paragraph 6.3.2.1 of this Operating Manual



## Preview UDS 3-5 Settings

Refer to paragraph 6.3.2.1 of this Operating Manual

### **Start/Stop t-FLOORMAP L recording**

Click on  or press  on front panel keyboard or **F8** or **<Alt>+<S>** on external keyboard to start **t-FLOORMAP L** recording

 button becomes invisible since **t-FLOORMAP L** recording starts.  button occupies its position. Click on  or press  on front panel keyboard or **F8** or **<Alt>+<S>** on external keyboard to terminate **t-FLOORMAP L** recording prior to automatic completion

 button becomes invisible after completion / termination of **t-FLOORMAP L** record.  button returns to its position

### **Save record into a file**

Refer to paragraph 6.3.2.1 of this Operating Manual

### **Open record from a file and starting postprocessing session**

Refer to paragraph 6.3.2.1 of this Operating Manual

### **Return to UDS 3-5 main operating surface**

Refer to paragraph 6.3.2.1 of this Operating Manual

### 6.6.2.2. t-FLOORMAP L – Scanning

- Apply probes pair to test object in the start point of selected scanning line

- Click on **Start** or press **I** on front panel keyboard or **F8** or **<Alt>+<S>** on external keyboard
- Guide probe over the scanning line synchronously with *Position Icon* moving with constant speed above **t-FLOORMAP L** record field – typical scanning progress display during is shown and explained below

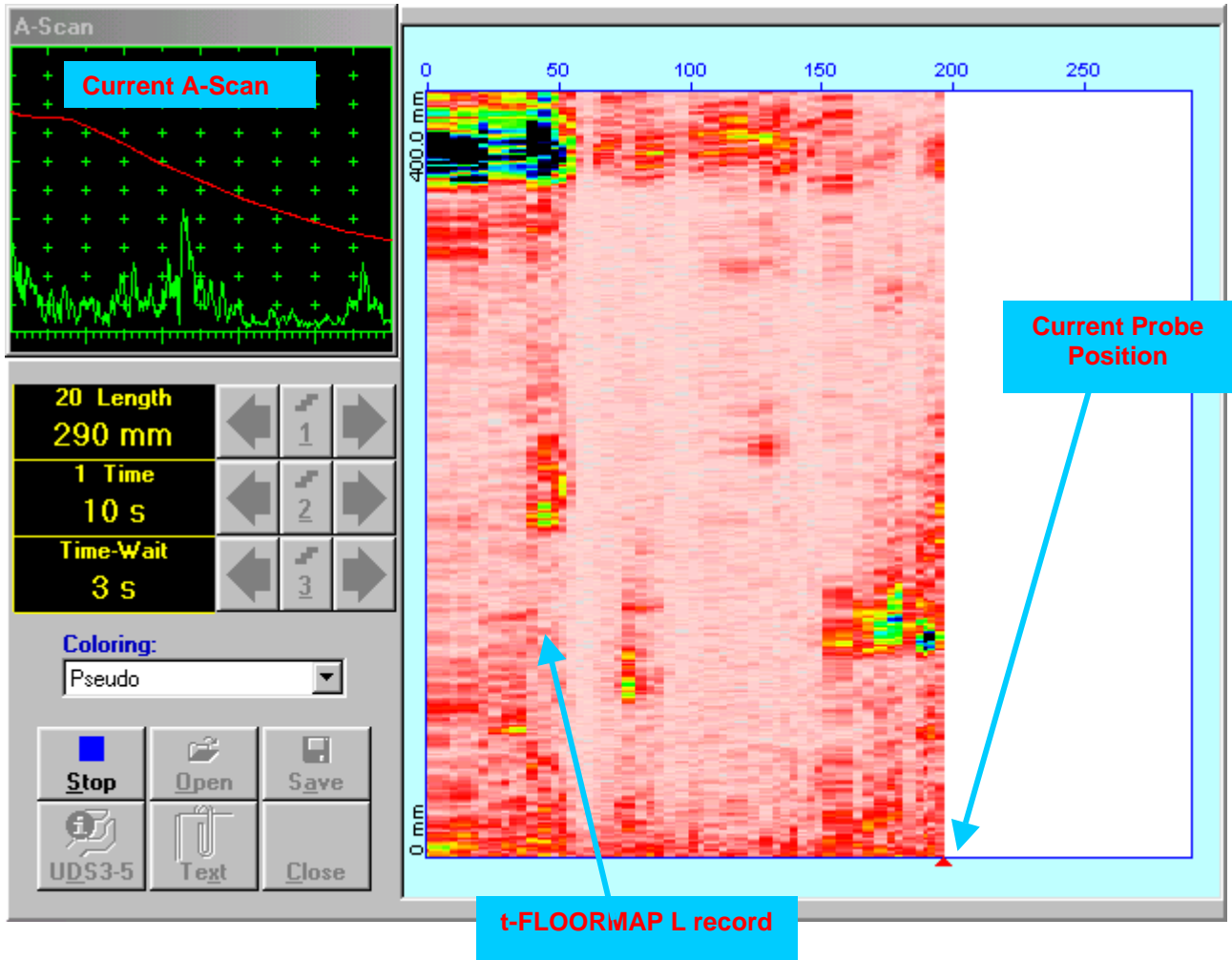

### 6.6.2.3. FLOORMAP L – Prior to Scanning

FLOORMAP\_L control panel is shown below

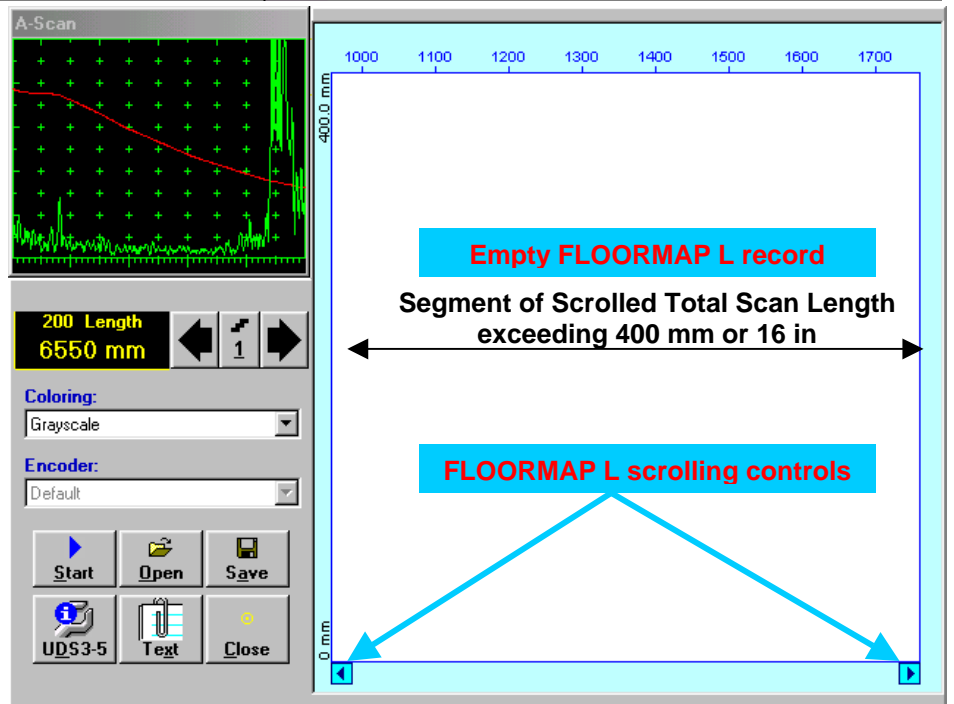
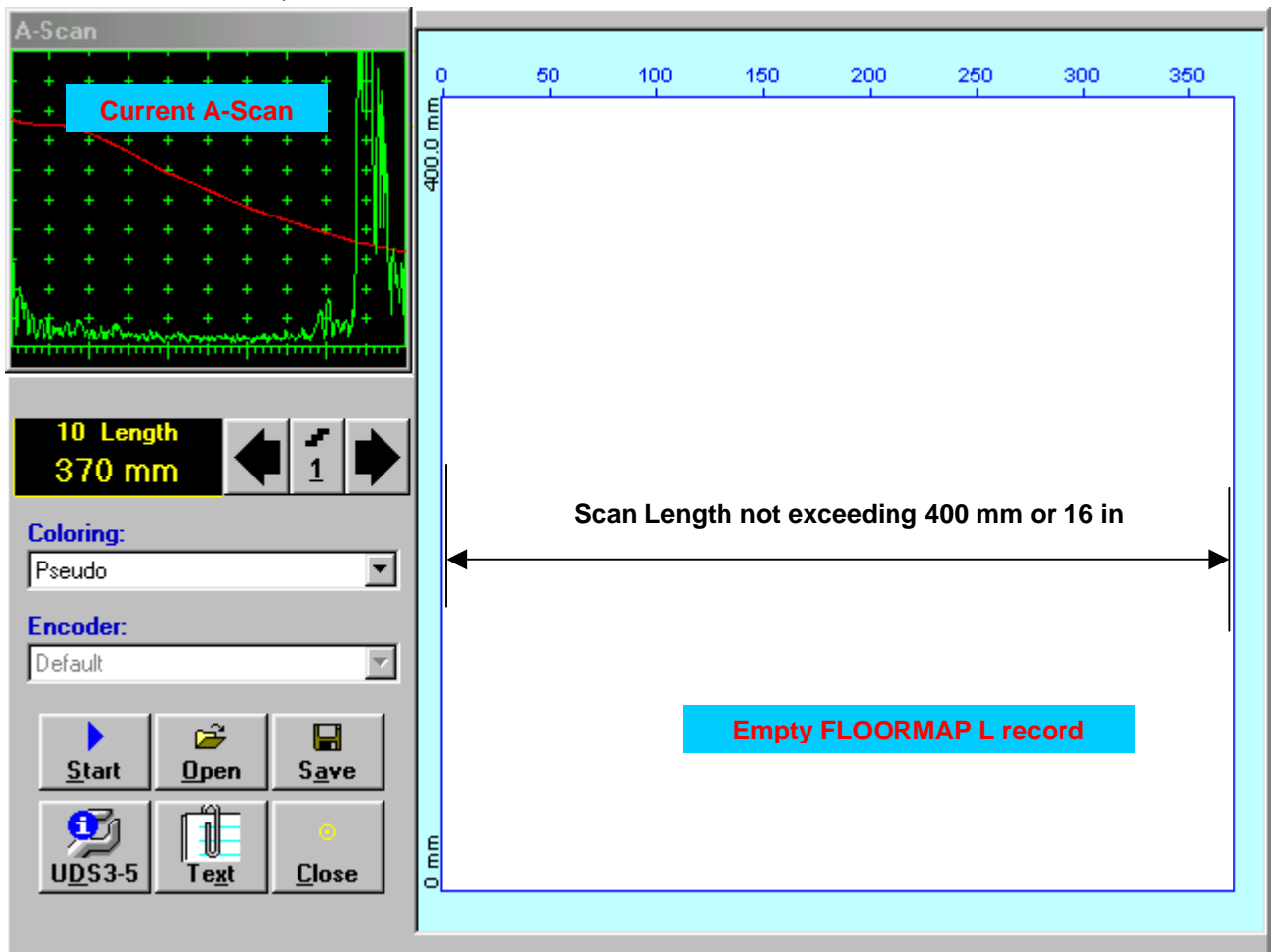

## Scan Length

**Length** represents length of section of test object to be displayed, over which probe will be scanning during recording period

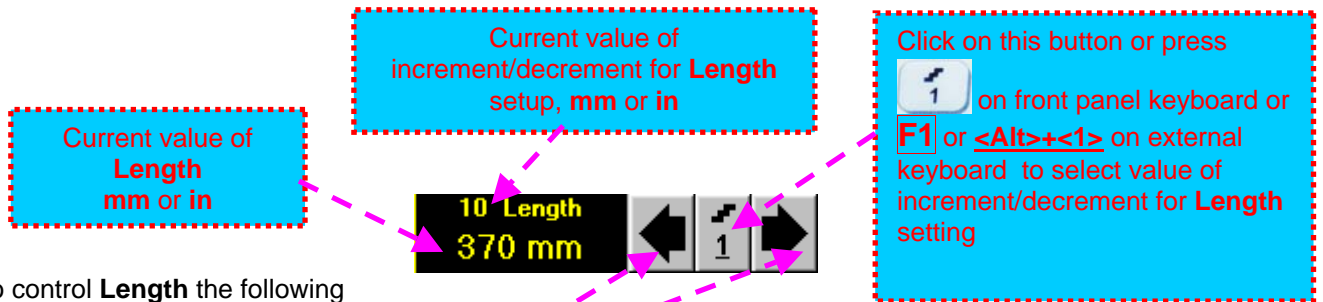





To control **Length** the following manipulations are applicable:









- **Mouse / Touch Screen**

- Click on corresponding **button**

- **Keyboard**

- Press  on front panel keyboard or **F1** on external keyboard ⇒ **Length** fore color changes to white - then use , , ,  on front panel keyboard or , , ,  on external keyboard

- **Combined**

- Click on **Length** ⇒ **Length** fore color changes to white - then use , , ,  on front panel keyboard or , , ,  on external keyboard



The value of **Length** is adjustable between 50 and 20000 **mm** or 2 and 800 **in**

## FLOORMAP L Record Palette

There are four palettes available through – select **through**



## Encoder

Select encoder to be used through appropriate box



Clamp probe into encoder – refer to Chapter 7 of this Operating Manual

Connect encoder to appropriate input on the rear panel of **ISONIC 2007** instrument



## Insert Text Note





Refer to paragraph 6.3.2.1 of this Operating Manual

## Preview UDS 3-5 Settings

Refer to paragraph 6.3.2.1 of this Operating Manual

### **Start/Stop FLOORMAP L recording**

Click on  or press  on front panel keyboard or **F8** or **<Alt>+<S>** on external keyboard to start **FLOORMAP L** recording

 button becomes invisible since **FLOORMAP L** recording starts.  button occupies its position. Click on  or press  on front panel keyboard or **F8** or **<Alt>+<S>** on external keyboard to terminate **FLOORMAP L** recording

 button becomes invisible after termination of **FLOORMAP L** record.  button returns to its position

### **Save record into a file**

Refer to paragraph 6.3.2.1 of this Operating Manual

### **Open record from a file and starting postprocessing session**

Refer to paragraph 6.3.2.1 of this Operating Manual

### **Return to UDS 3-5 main operating surface**

Refer to paragraph 6.3.2.1 of this Operating Manual

### 6.6.2.4. FLOORMAP L – Scanning

- Apply probes pair to test object in the start point of selected scanning line
- Click on **Start** or press **I** on front panel keyboard or **F8** or **<Alt>+<S>** on external keyboard
- Guide probe over the scanning line – typical scanning progress display during is shown and explained below

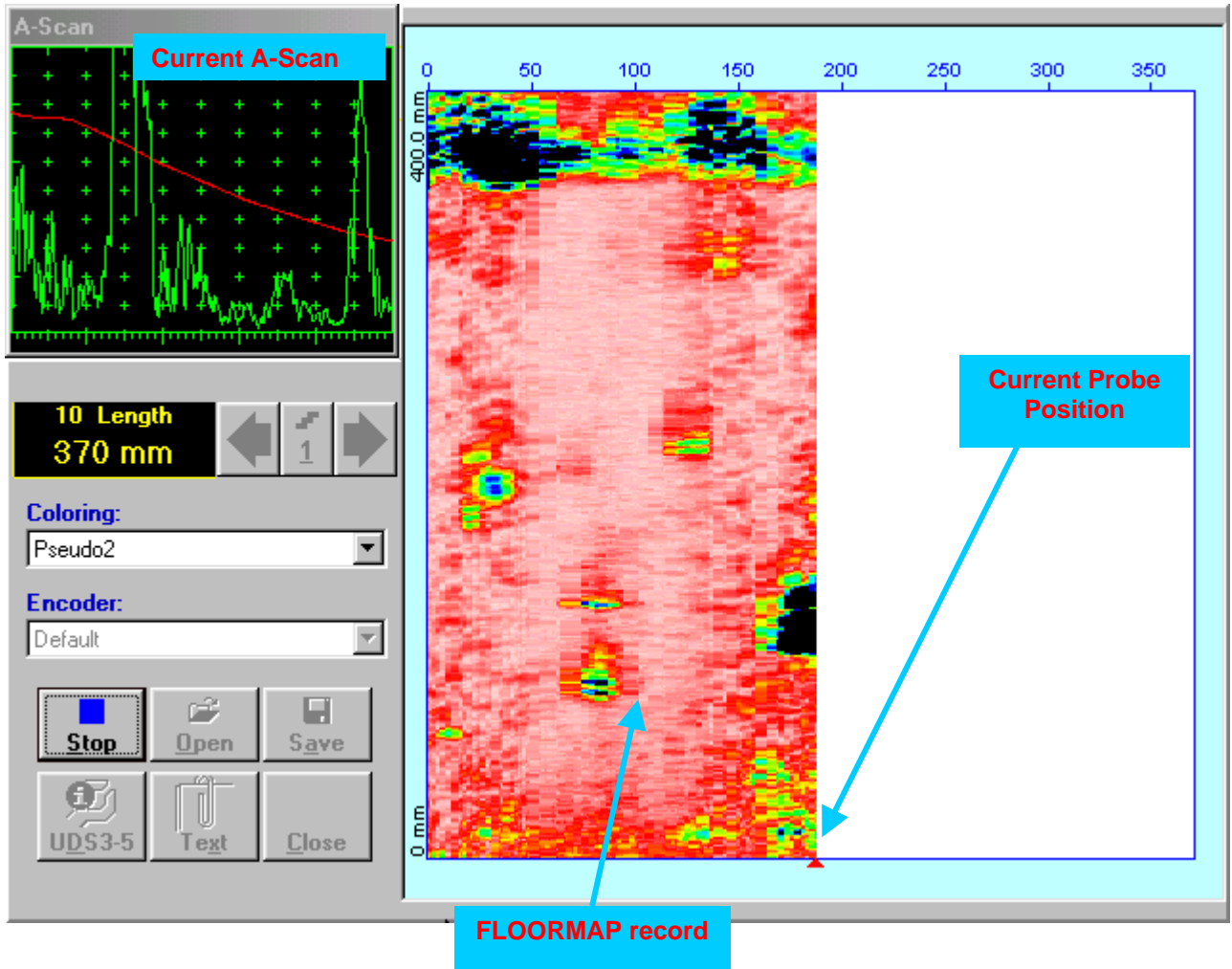



### 6.6.2.5. t-FLOORMAP L / FLOORMAP L – Postprocessing

Versatile postprocessing of t-FLOORMAP L/FLOORMAP L (CB-Scan) records is featured with:



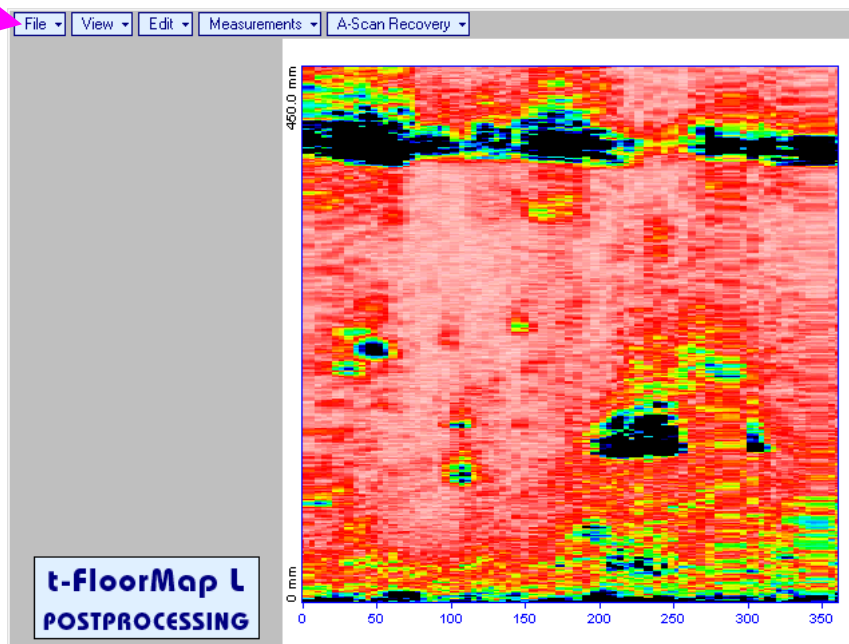

- ❑ Sizing of the defects at any location along stored images (coordinates, projection size, amplitude-based evaluation)
- ❑ Play-back and evaluation of **A-Scans** obtained and captured during t-FLOORMAP L / FLOORMAP L (CB-Scan) defects imaging and recording
- ❑ Defects outlining and pattern recognition based on **A-Scan** sequence analysis – **Echo Dynamic Pattern Analysis**
- ❑ Reconstruction of t-FLOORMAP L / FLOORMAP L (CB-Scan) defects images for various **Gain, Reject, and off-line Gate** level settings
- ❑ **DAC/DGS t-FLOORMAP L / FLOORMAP L (CB-Scan)** normalization

The screen as below appears upon opening file. All postprocessing procedures are performed through **menu bar** – touch screen stylus or front panel or external mouse to be used



#### Menu Bar Functions

- **File→Open** – opens new t-FLOORMAP L / FLOORMAP L (CB-Scan) file
- **File→Snapshots→Add Snapshot** – stores current postprocessing screen snapshot accompanied with appropriate settings and measurements into *postprocessing session memory stack*
- **File→Snapshots→Restore Snapshot** – recalls earlier stored postprocessing screen snapshot accompanied with appropriate settings and measurements from *postprocessing session memory stack*
- **File→Snapshots→Delete Snapshot** – deletes earlier stored postprocessing screen snapshot accompanied with appropriate settings and measurements from *postprocessing session memory stack*
- **File→Print** – prints out postprocessing screen snapshot(s) accompanied with appropriate settings and measurements
- **File→Exit** – returns to t-FLOORMAP L / FLOORMAP L (CB-Scan) control panel
- **View→Instrument** – indicates setup of **UDS 3-5** Pulser Receiver used for scanning when file was created
- **View→Inspection Data** – indicates operator's comments entered prior to scanning
- **View→Coloring** – selects palette for t-FLOORMAP L / FLOORMAP L (CB-Scan) image

- **A-Scan Recovery →ON** – generates *cursor representing sound path* of probe's central beam in the object under test that may be guided over **t-FLOORMAP L / FLOORMAP L (CB-Scan)** image using either touch screen stylus or mouse or  ,  on front panel keyboard or  ,  on external keyboard – corresponding **A-Scan** is recovered synchronously according to *sound path cursor* position. Indication of starting position of cursor (**L**) corresponding to probe's center accompanies recovered **A-Scan**. On the recovered **A-Scan** there is red **Off-line Gate** presented. Initially **Off-line Gate** covers whole **A-Scan** range

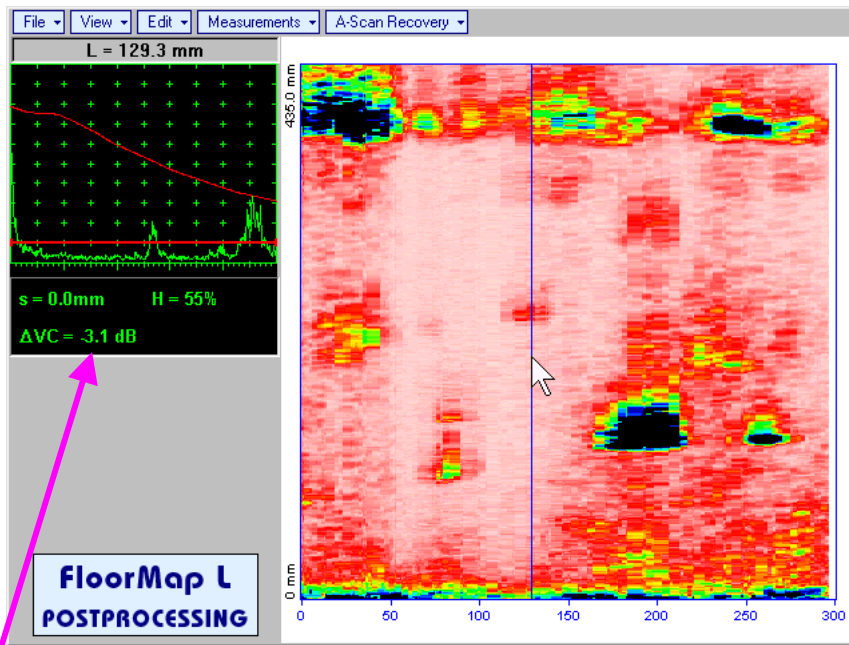

**Automatic Measurements Display** accompanies recovered **A-Scan** and indicates (refer to paragraphs 5.1.12, 5.2.13.1 and 5.2.13.2 of this Operating Manual):

- sound path **s** between reflector and probe's center (measurement mode - **Flank**)
- amplitude **H** of the maximal signal in the **Off-line Gate** expressed in % of full **A-Scan** height
- **ΔVC (dB to DAC)** of the maximal signal in the **Off-line Gate** provided that DAC was active whilst recording **t-FLOORMAP L / FLOORMAP L (CB-Scan)** data

To fix position of *sound path cursor* with corresponding recovered **A-Scan** and **Automatic**





**Measurements Display** data left mouse click or release touch screen stylus or press  on front panel keyboard or **Enter** on external keyboard

To interrupt recovery of **A-Scans** and empty **A-Scan Recovery** field right mouse click or press  on front panel keyboard or **Esc** on external keyboard

- **A-Scan Recovery →OFF** – erases *sound path cursor* with recovered **A-Scan**, indicator of *sound path cursor* position, and **Automatic Measurements Display**



- **Edit→Change Gain→ON** – generates *cursor representing sound path* of probe's central beam in the object under test that may be guided over **t-FLOORMAP L / FLOORMAP L (CB-Scan)** image using either touch screen stylus or mouse or  ,  on front panel keyboard or  ,  on external keyboard – corresponding **A-Scan** is recovered synchronously according to *sound path cursor* position.

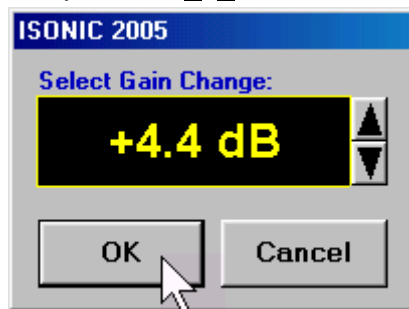

To select reference **A-Scan** release touch screen stylus or left mouse click or press  on front panel keyboard or **Enter** on external keyboard – this generates subwindow allowing off-line re-adjusting of **Gain** for all **A-Scans** captured during **t-FLOORMAP L / FLOORMAP L (CB-Scan)**

recording in **±6dB** range with **±0.1 dB** increments through clicking or pressing and holding on  or pressing  ,  on front panel keyboard or  ,  on external keyboard

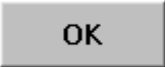



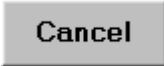







During **Gain** re-adjusting reference **A-Scan** is modified accordingly. Upon completing re-adjusting **Gain**

click on  or press  on front panel keyboard or **Enter** on external keyboard – this applies new **Gain** value to all captured **A-Scans** and redraws **t-FLOORMAP L / FLOORMAP L (CB-Scan)** image accordingly

To interrupt re-adjusting of **Gain** click on  or press  on front panel keyboard or **Esc** on external keyboard

- **Edit→Change Gain→OFF** – negates **Gain** re-adjustment and returns to originally recorded **t-FLOORMAP L / FLOORMAP L (CB-Scan)** image and original **Gain** setting

- Edit→ROI→ON** – generates *cursor representing sound path* of probe's central beam in the object under test that may be guided over **t-FLOORMAP L / FLOORMAP L (CB-Scan)** image using either touch screen stylus or mouse or   on front panel keyboard or   on external keyboard – corresponding **A-Scan** is recovered synchronously according to *sound path cursor* position. To select reference **A-Scan** release touch screen stylus or left mouse click or press  on front panel keyboard or **Enter** on external keyboard – this generates **Off-line Gate** controls       allowing to redefine **Region Of Interest** for **t-FLOORMAP L / FLOORMAP L (CB-Scan)** imaging

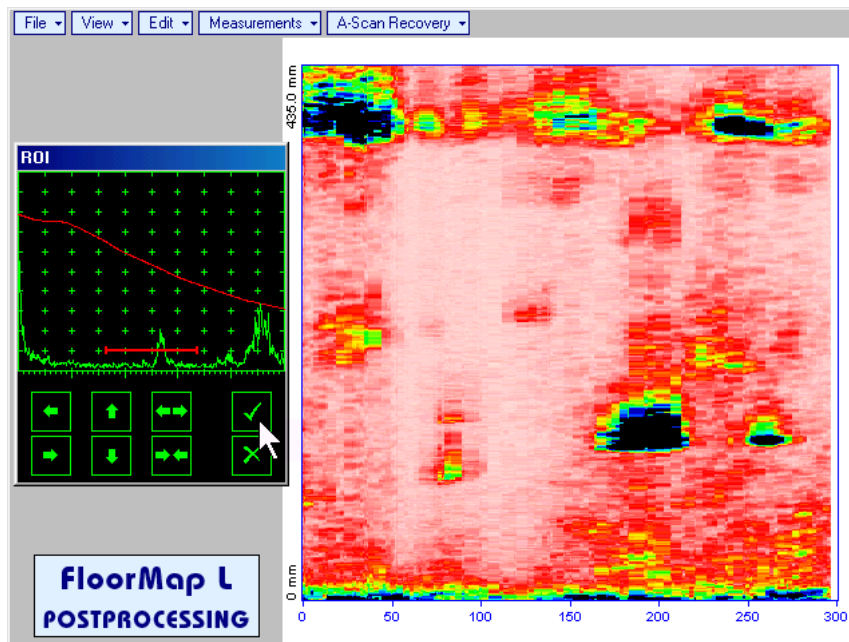

To interrupt selection of reference of **A-Scan** right mouse click or press  on front panel keyboard or **Esc** on external keyboard

To interrupt re-adjustment of **Region Of Interest** after selection of reference of **A-Scan** click on 



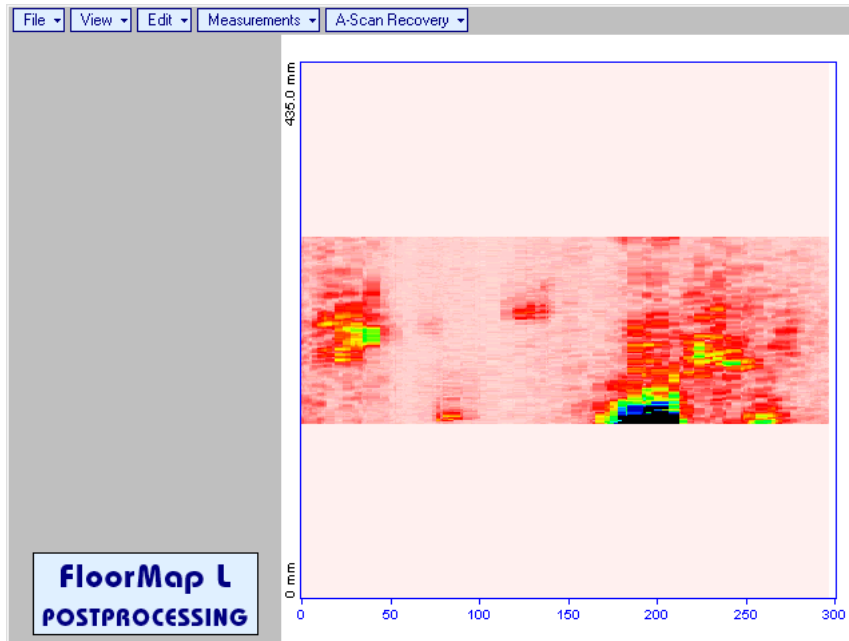

Upon completing redefining of **Region Of Interest** click on  – this applies new **Off-line Gate** to all captured **A-Scans** and updates **t-FLOORMAP L / FLOORMAP L (CB-Scan)** image accordingly – only segment of **t-FLOORMAP L / FLOORMAP L (CB-Scan)** image covered by newly adjusted **Off-line Gate** remains visible

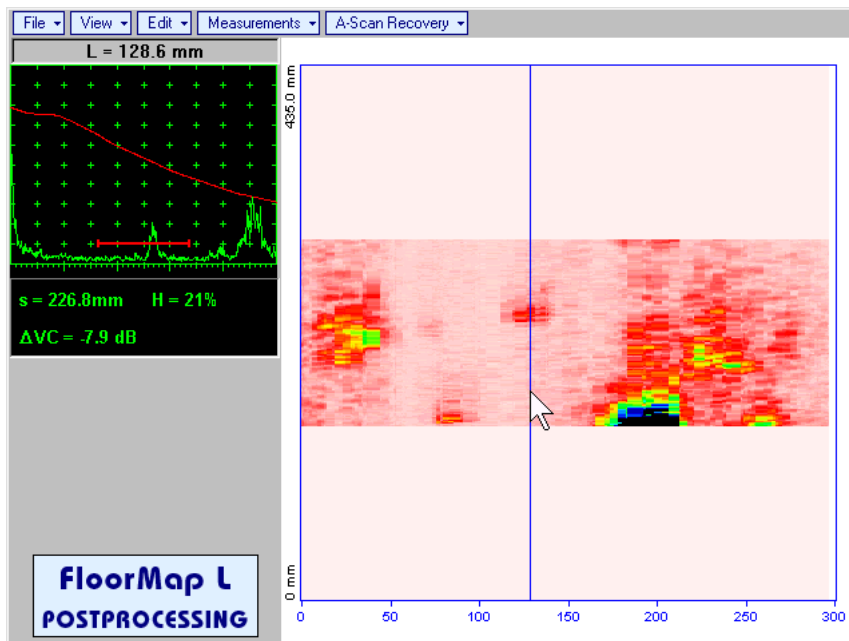

It is possible then to perform **A-Scan** signal evaluation using newly adjusted **Off-Line Gate** through **A-Scan Recovery** → **ON**



- **Edit**→**ROI**→**OFF** – negates **Off-line Gate** re-adjustment and returns to originally recorded **t-FLOORMAP L / FLOORMAP L (CB-Scan)** image and initial **Off-line Gate** setting

- **Edit→Filtering→ON** – generates *amplitude palette bar* with *sliding cursor*, which may be controlled using either touch screen stylus or mouse or ,  on front panel keyboard or ,  on external keyboard . Position of the *sliding cursor* on the *amplitude palette bar* determines filtering level, which is indicated as **Filtering**. All elements of **t-FLOORMAP L / FLOORMAP L (CB-Scan)** image representing signal amplitude below filtering level are suppressed:

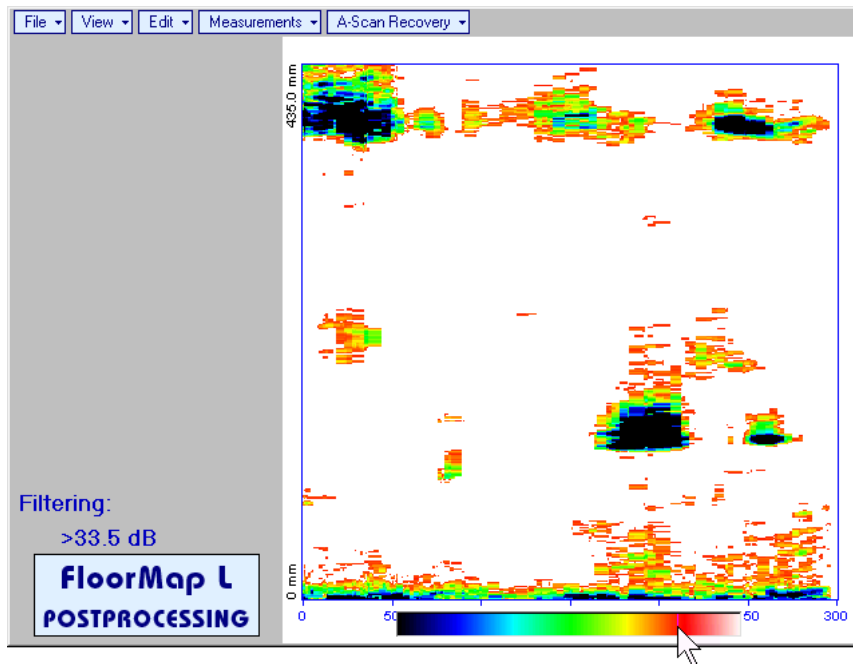

- **Edit→Filtering→OFF** – returns to originally recorded **t-FLOORMAP L / FLOORMAP L (CB-Scan)** image and removes **Filtering** indication

- **Edit**→**Normalize to DAC**→**ON** – applies **DAC/DGS** normalized color palette to **t-FLOORMAP L / FLOORMAP L (CB-Scan)** image, which was recorded with active **DAC/DGS** and redraws **t-FLOORMAP L / FLOORMAP L (CB-Scan)** image correspondingly (**dB to DAC/DGS** normalization)

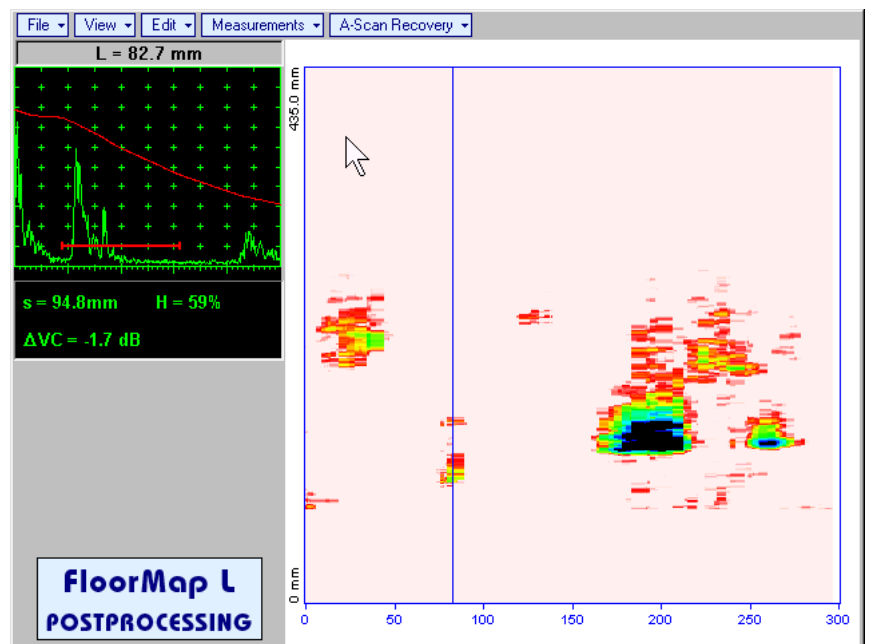
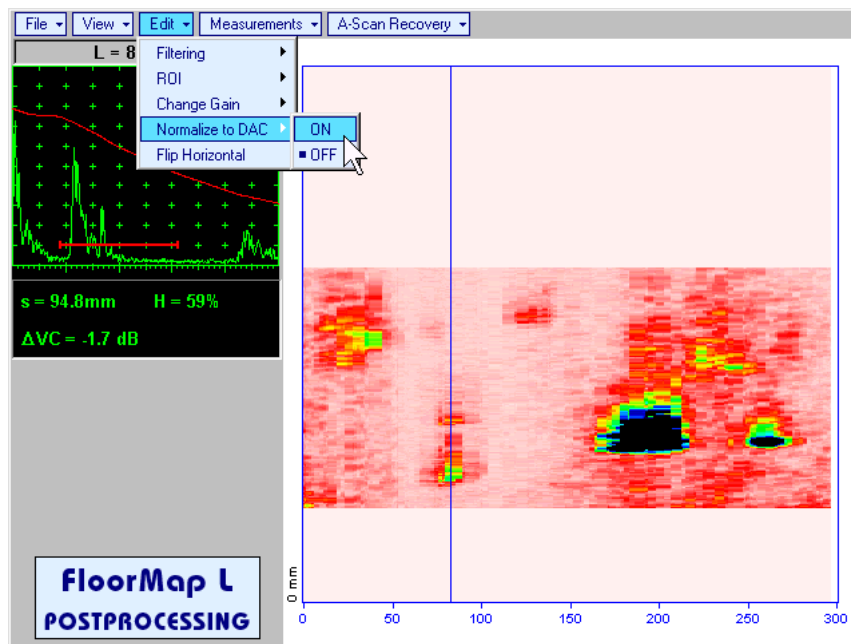

- **Edit**→**Normalize to DAC**→**OFF** – negates **dB to DAC/DGS** normalization and returns to originally recorded **t-FLOORMAP L / FLOORMAP L (CB-Scan)** image





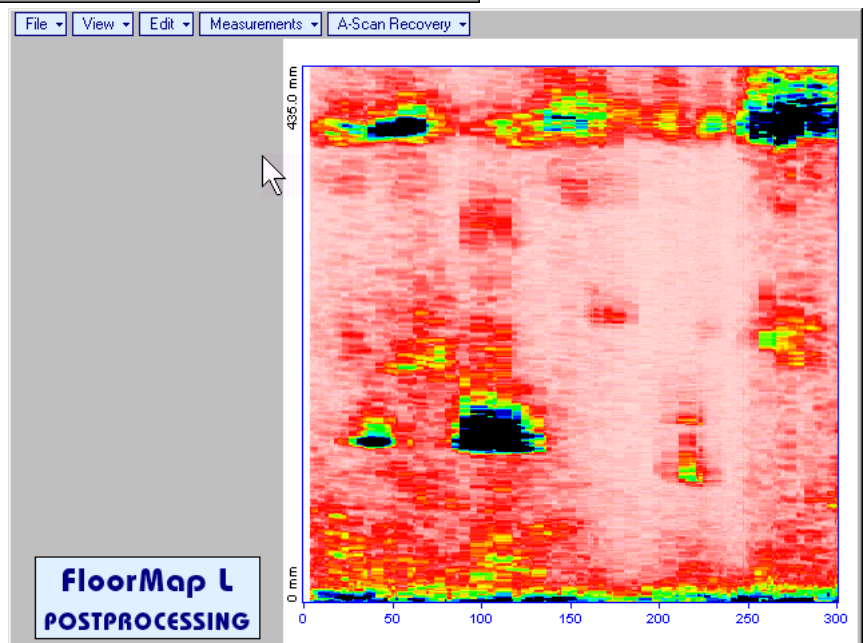
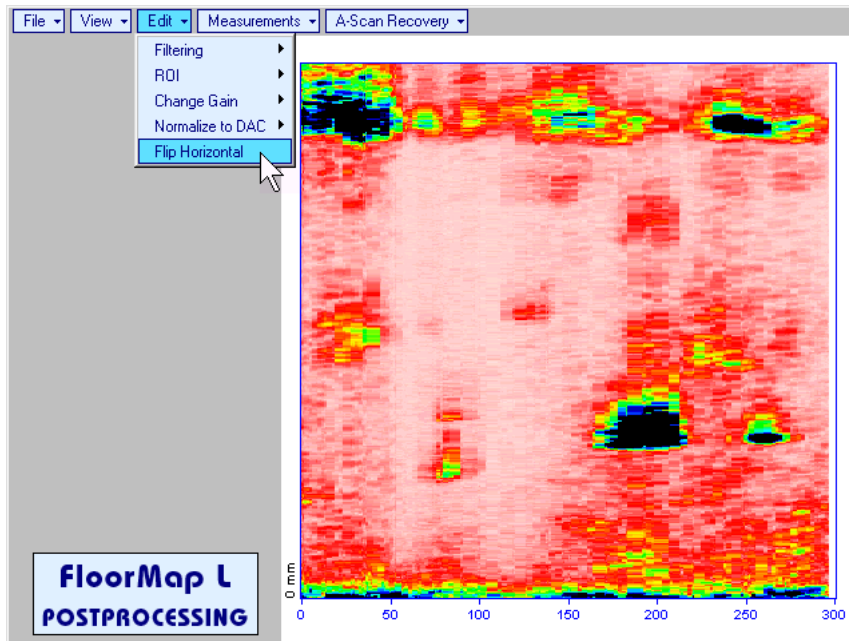

Applying of **Edit**→**Normalize to DAC**→**ON** or **Edit**→**Normalize to DAC**→**OFF** negates **Filtering** (**Edit**→**Filtering**→**OFF**)

- **Edit→Flip Horizontal** – reorders **A-Scans** captured during **t-FLOORMAP L / FLOORMAP L (CB-Scan)** recording in reverse succession and redraws **t-FLOORMAP L / FLOORMAP L (CB-Scan)** image accordingly. This service function may be useful for merging scans of neighboring sections of an object, which were scanned in opposite direction due to access conditions, etc







Applying of **Flip Horizontal** function empties *postprocessing session memory stack*

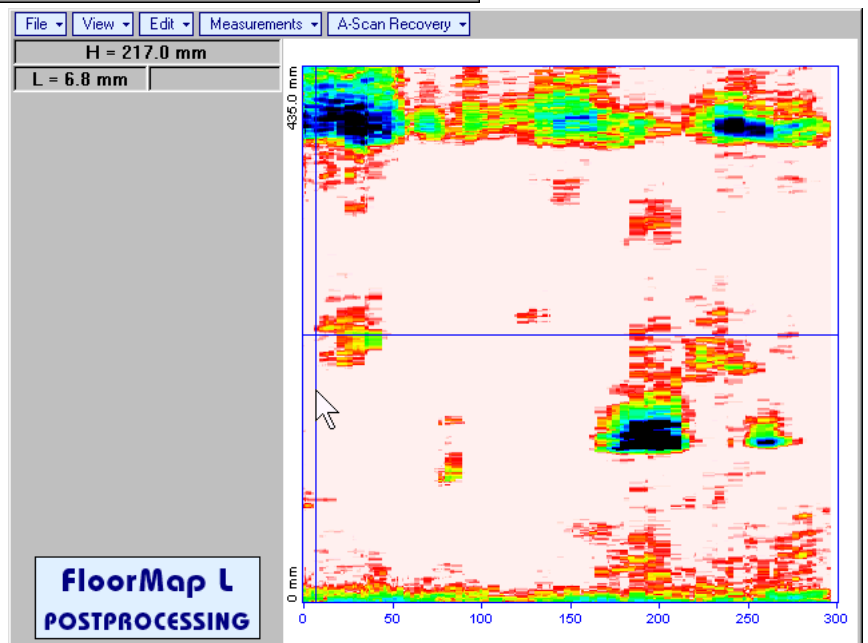
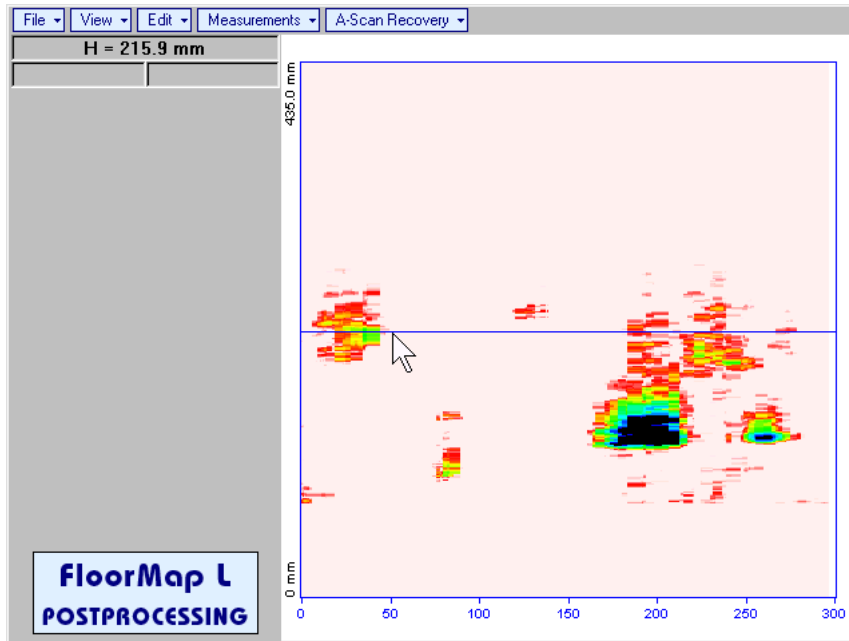

- Measurements→Add Measure→Length** – generates horizontal cursor that may be guided over **t-FLOORMAP L / FLOORMAP L (CB-Scan)** image using either touch screen stylus or mouse or ,  on front panel keyboard or ,  on external keyboard . Horizontal cursor to be positioned over defect area, which's length along the scanning line to be evaluated. Position of horizontal cursor characterizes its coordinate (**H**) relatively scanning line. To fix position of horizontal cursor left mouse click or release touch screen stylus or press  on front panel keyboard or **Enter** on external keyboard



First vertical cursor appears upon fixing horizontal cursor, it may be guided over **t-FLOORMAP L / FLOORMAP L (CB-Scan)** image using either touch screen stylus or mouse or ,  on front panel keyboard or ,  on external keyboard . Coordinate of the first vertical cursor along **t-FLOORMAP L / FLOORMAP L (CB-Scan)** image (**L**) is indicated synchronously. To fix position of the first vertical cursor left mouse click or release touch screen stylus or press  on front panel keyboard or **Enter** on external keyboard

Second vertical cursor appears upon fixing first one, it may be manipulated by the same way. Coordinate of the second vertical cursor along **t-FLOORMAP L / FLOORMAP L (CB-Scan)** image measured with relatively first vertical cursor (**dL**) is indicated synchronously, it represents projection length of defect area provided that vertical cursors are placed properly

To interrupt length measurement procedure at any moment right mouse click or press  on front panel keyboard or **Esc** on external keyboard

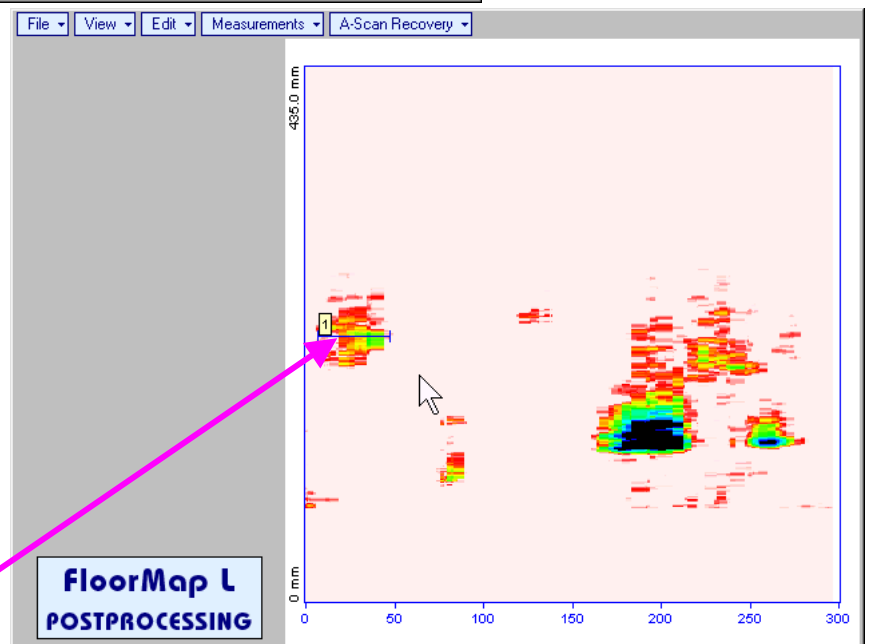
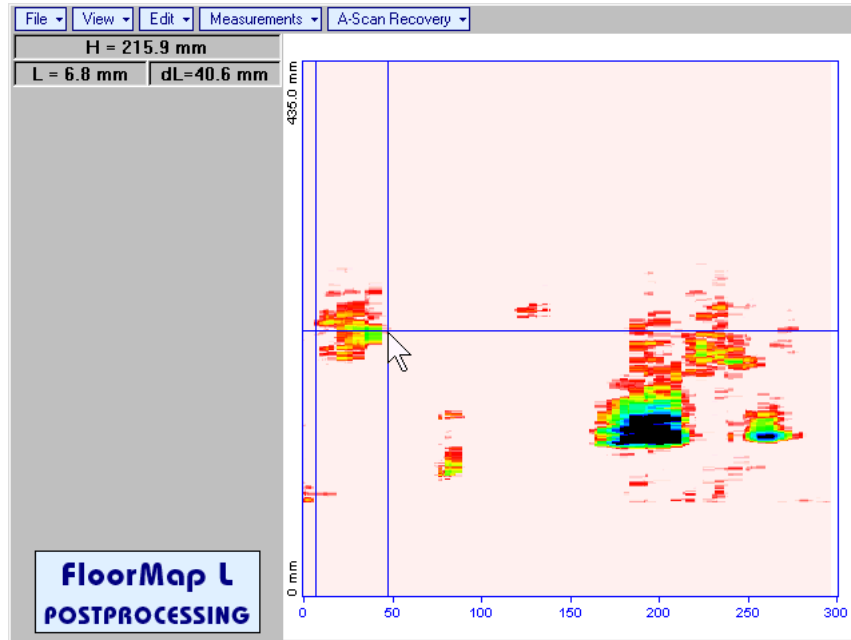

Horizontal **length measurement mark** appears on the **t-FLOORMAP L / FLOORMAP L (CB-Scan)** image upon fixing position of second vertical cursor

Length measurement results may be recalled through double click on the *length measurement mark*

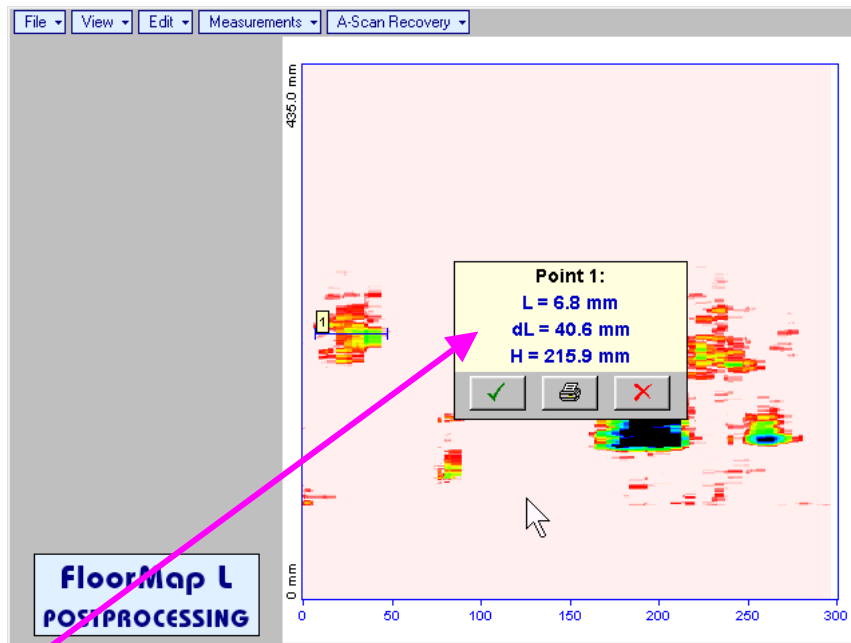

In the **subwindow** appearing:





- **L** is coordinate of left end of the *length measurement mark*
- **dL** is length of defect area covered by *length measurement mark*
- **H** is distance between scanning line and *length measurement mark*

Clicking on  will print current screen snapshot accompanied with *length measurement mark* data

Clicking on  will hide subwindow with *length measurement mark* data

Clicking on  will hide subwindow with *length measurement mark* data and erase corresponding *length measurement mark*



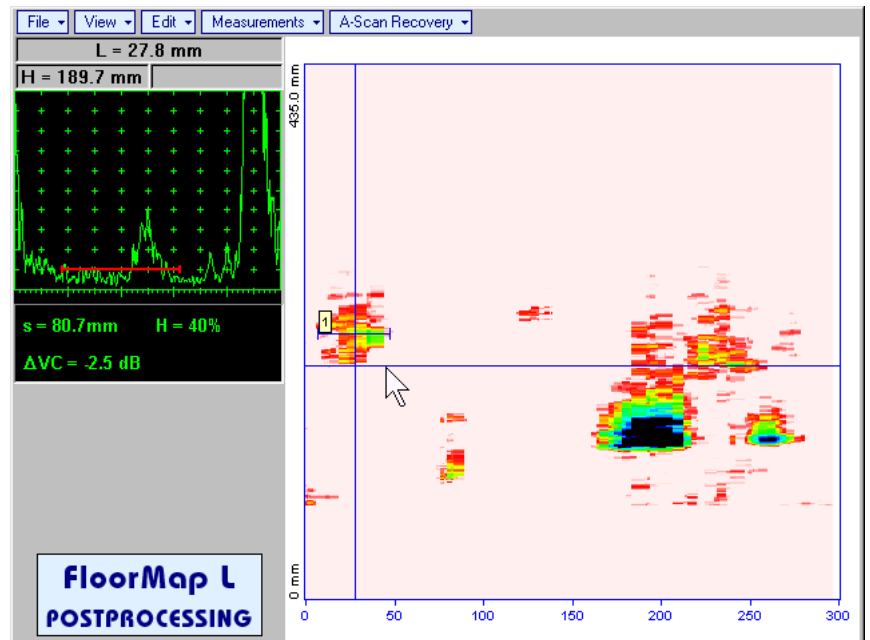
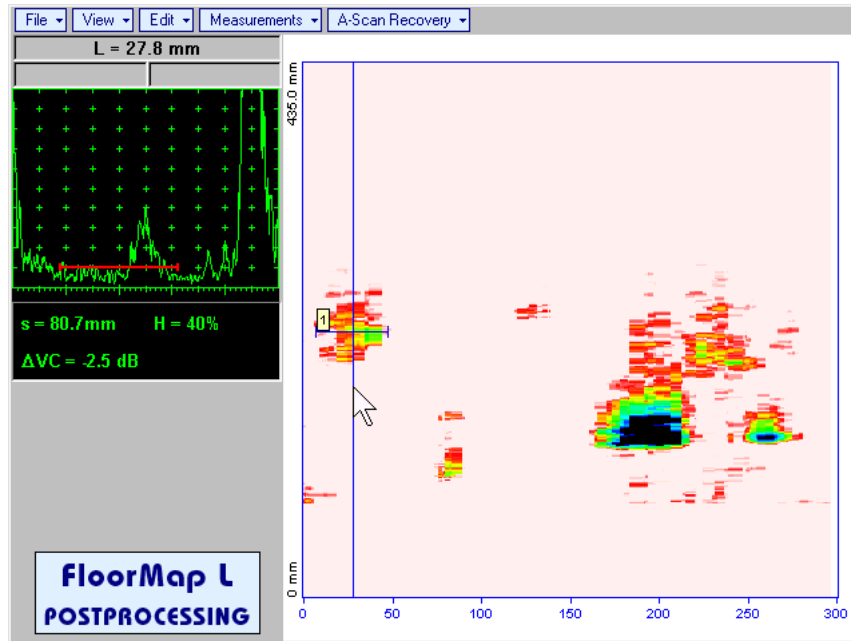

- **Measurements→Add Measure→Width** – generates *cursor representing sound path* of probe's central beam in the object under test that may be guided over **t-FLOORMAP L / FLOORMAP L (CB-Scan)**

image using either touch screen stylus or mouse or ,  on front panel keyboard or ,  on external keyboard – corresponding **A-Scan** is recovered synchronously according to *sound path cursor* position. Indication of starting position of cursor (**L**) corresponding to probe's center accompanies recovered **A-Scan**. *Sound path cursor* to be positioned over defect area, which's width along the sound path line to be evaluated. To fix position of *sound path cursor* left mouse click or release touch screen

stylus or press  on front panel keyboard or **Enter** on external keyboard



First horizontal cursor appears upon fixing *sound path cursor*, it may be guided over **t-FLOORMAP L /**

**FLOORMAP L (CB-Scan)** image using either touch screen stylus or mouse or ,  on front panel keyboard or ,  on external keyboard . Coordinate of the first horizontal cursor along sound path (**H**) is indicated synchronously

To fix position of the first horizontal cursor left mouse click or release touch screen stylus or press  on front panel keyboard or **Enter** on external keyboard . Second horizontal cursor appears upon fixing first one, it may be manipulated by the same way. Coordinate of the second horizontal cursor along sound path measured with relatively first horizontal cursor (**dH**) is indicated synchronously, it represents projection with of defect area provided that horizontal cursors are placed properly. To interrupt width

measurement procedure at any moment right mouse click or press  on front panel keyboard or **Esc** on external keyboard

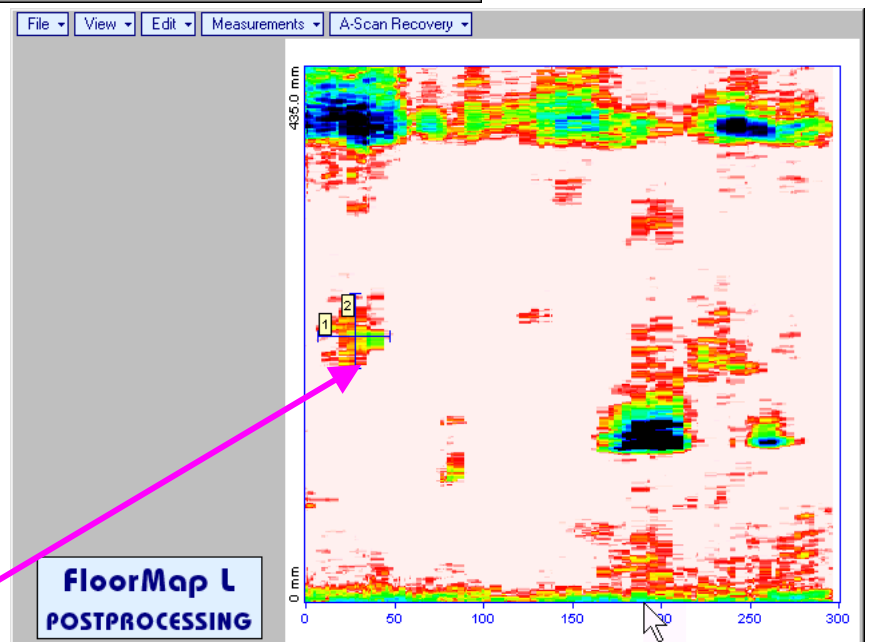
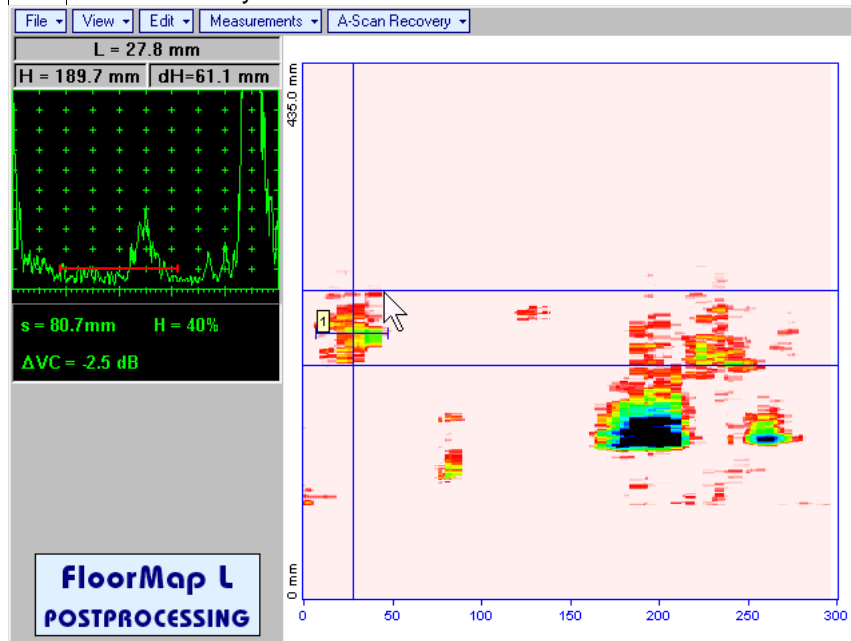

Vertical **width measurement mark** appears on the **t-FLOORMAP L / FLOORMAP L (CB-Scan)** image upon fixing position of second horizontal cursor

Width measurement results may be recalled through double click on the *width measurement mark*. This causes appearance of corresponding A-Scan and **subwindow**

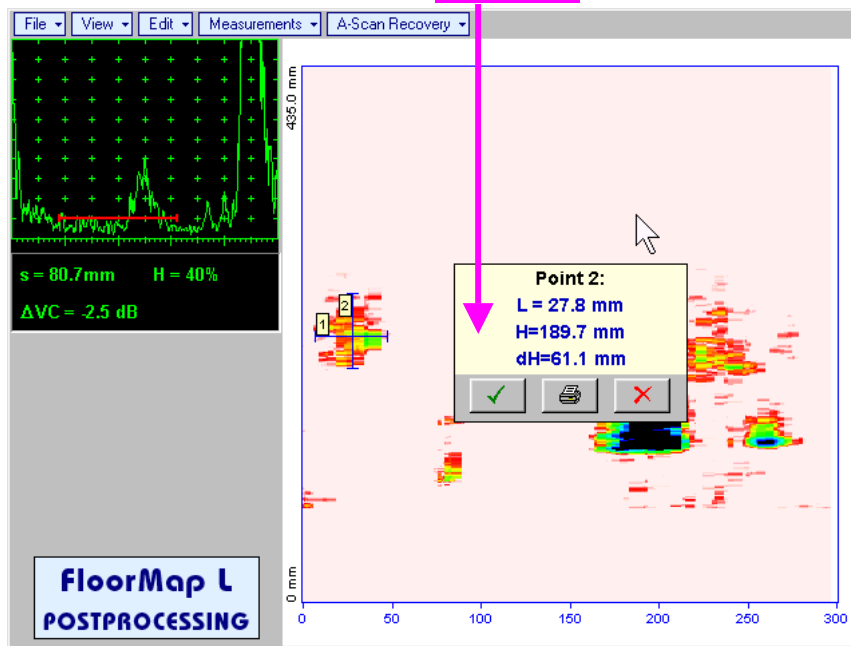

In the subwindow appearing:

- **L** is coordinate of the *width measurement mark* along scanning line
- **H** is distance between scanning line and *width measurement mark*
- **dH** is width of defect area covered by *width measurement mark*

Clicking on  will print current screen snapshot accompanied with *width measurement mark* data

Clicking on  will hide subwindow with *width measurement mark* data

Clicking on  will hide subwindow with *width measurement mark* data and erase corresponding *width measurement mark*

- **Measurements** → **Clear Last** – erases last *length* or *width measurement mark* placed on the **t-FLOORMAP L / FLOORMAP L (CB-Scan)** image
- **Measurements** → **Clear All** – erases all *length* and *width measurement marks* placed on the **t-FLOORMAP L / FLOORMAP L (CB-Scan)** image









# 7. Recording and Imaging – Dual Channel



## 7.1. Main Recording Menu – Dual Channel

Main Recording Menu for Dual Channel Mode is shown below:



There are 3 dual channel recording modes available:

- ◆ **Dual Channel Thickness Profile imaging and recording – BScan(Th)** – click on  or press  on front panel keyboard or **F1** on external keyboard
- ◆ **Dual Channel TOFD Inspection – RF B-Scan and D-Scan Imaging – TOFD** – click  or press  on front panel keyboard or **F2** on external keyboard
- ◆ **CB-Scan horizontal plane-view imaging and recording of defects for shear, surface, and guided wave inspection – FLOORMAP L** click on  or press  on front panel keyboard or **F3** on external keyboard
- ◆ Postprocessing of dual channel scanning and recording files may be activated through click on  or pressing on  on front panel keyboard or **F4** on external keyboard

To return to **Main Operating Surface** of **UDS 3-5** pulser receiver channels click on  or press  or  on front panel keyboard or **Esc** or **F5** on external keyboard



**Main Recording Menu - Dual Channel** is generated from **Main Operating Surface** of **UDS 3-5** pulser receiver channels as it is described in the preamble to Chapter 5.2 of present Operating Manual. Dual channel recording and imaging mode utilizes settings of both **UDS 3-5** pulser receiver channels established prior to entering **Main Recording Menu for Dual Channel Mode**



## 7.2. Dual Channel Thickness Profile Imaging and Recording – BScan(Th)

### 7.2.1. Setting Pulser Receiver Channels



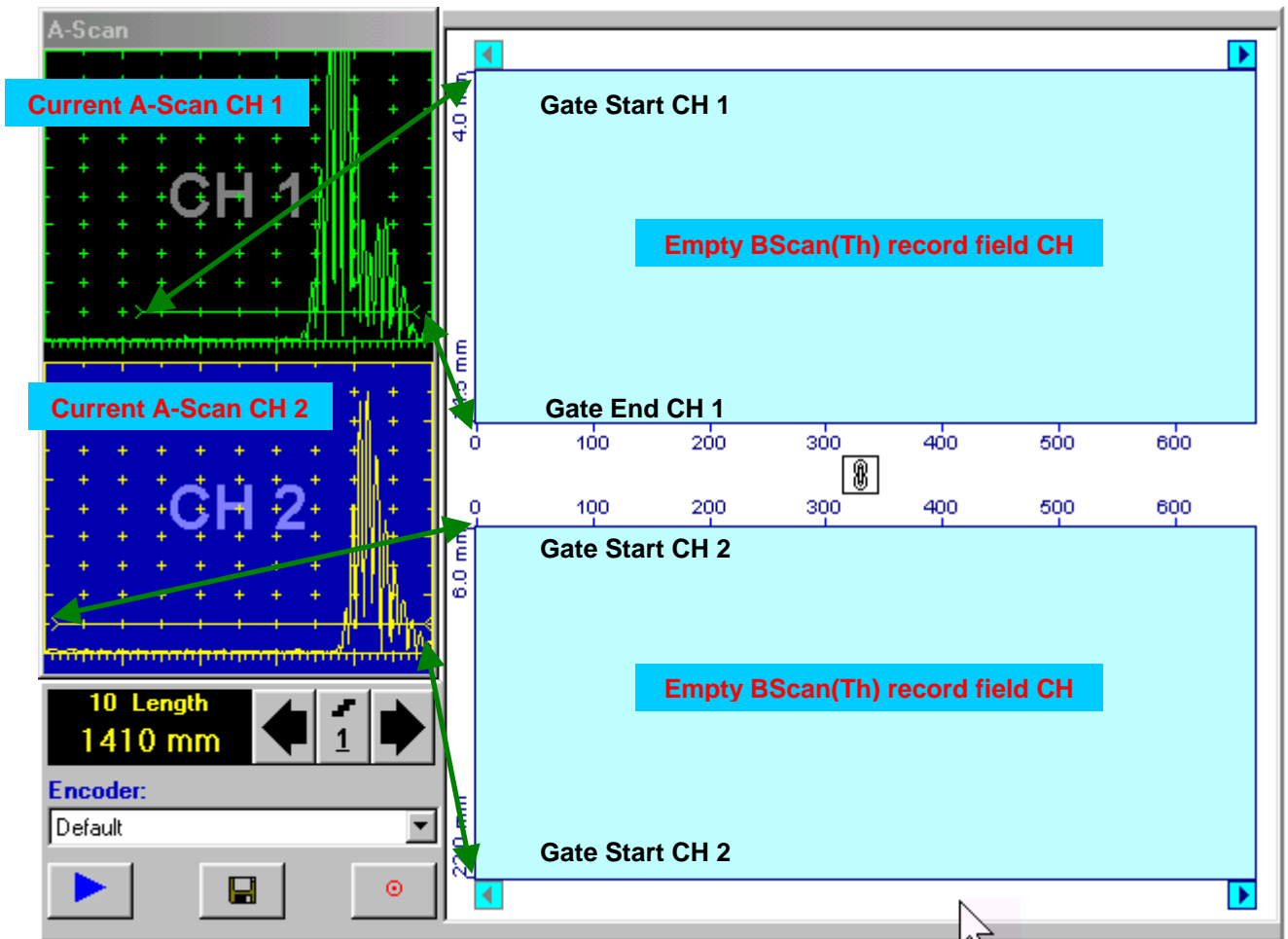

Each channel must be calibrated prior to entering **Main Recording Menu for Dual Channel Mode** according to paragraph 6.3.1 of present Operating Manual

### 7.2.2. Scanning

Dual channel **BScan(Th)** control panel is shown below



#### Scrolling Dual Channel BScan(Th) record fields

The scrolling is possible through clicking on  and  buttons. It is possible to scroll first and second channel images synchronously or separately from each other, mode of scrolling is defined through clicks on  /  button

## Scan Length

*Scan Length* – **Length** represents length of scanning line over section of test object to be displayed

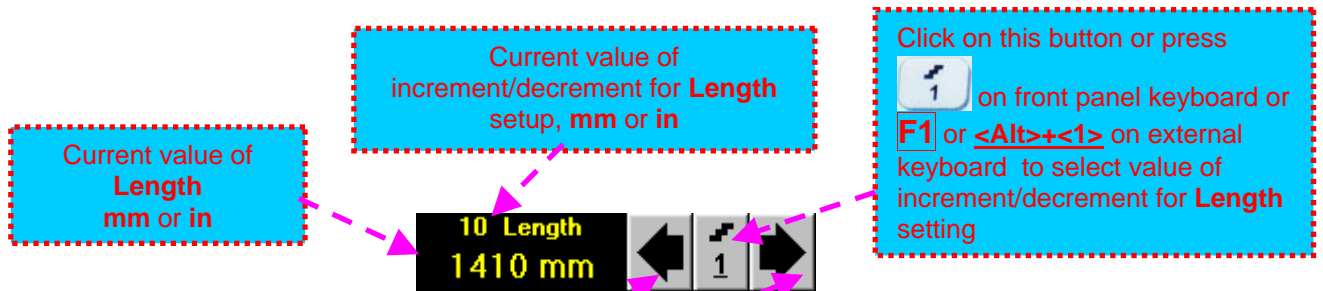

To control **Length** the following manipulations are applicable:

- **Mouse / Touch Screen**

- Click on corresponding **button**

- **Keyboard**

- Press **1** on front panel keyboard or **F1** on external keyboard ⇒ **Length** fore color changes to white - then use **↑**, **→**, **←**, **↓** on front panel keyboard or **↑**, **→**, **←**, **↓** on external keyboard

- **Combined**

- Click on **Length** ⇒ **Length** fore color changes to white - then use **↑**, **→**, **←**, **↓** on front panel keyboard or **↑**, **→**, **←**, **↓** on external keyboard



The value of **Length** is adjustable between 50 and 20000 **mm** or 2 and 800 **in**



## Encoder



Select encoder to be used through appropriate box



Connect encoder to its input on the rear panel of **ISONIC 2007** instrument

### Start/Stop Dual Channel BScan(Th) recording

Click on  or press  on front panel keyboard or **F8** on external keyboard to start **BScan(Th)** recording

 button becomes invisible since **BScan(Th)** recording starts.  button occupies its position.



Click on  or press  on front panel keyboard or **F8** or **<Alt>+<S>** on external keyboard to terminate **BScan(Th)** recording

 button becomes invisible after termination of **BScan(Th)** record.  button returns to its position

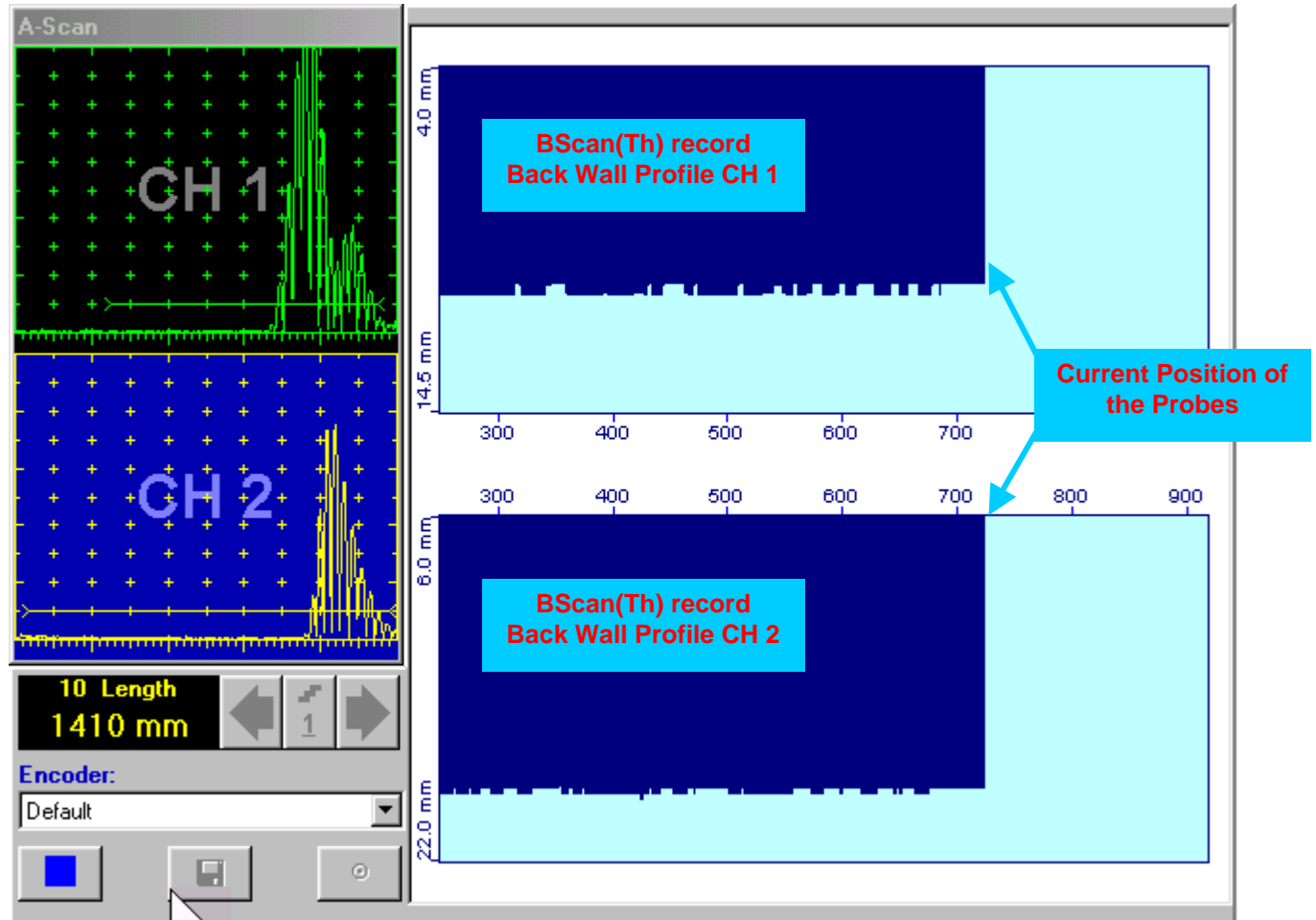

Typical screen during dual channel **BScan(Th)** recording is presented below:



### Save record into a file

Click on  or press  on front panel keyboard or **F12** on external keyboard to save captured **Dual Channel BScan(Th)** record accompanied with instrument calibration dump and text notes / comments into a file. Refer to paragraph 5.2.17 of this Operating Manual to proceed with file saving

### Return to Main Recording Menu - Dual Channel

Click on  or press  on front panel keyboard or **ESC** on external keyboard to return to **Main Recording Menu - Dual Channel**



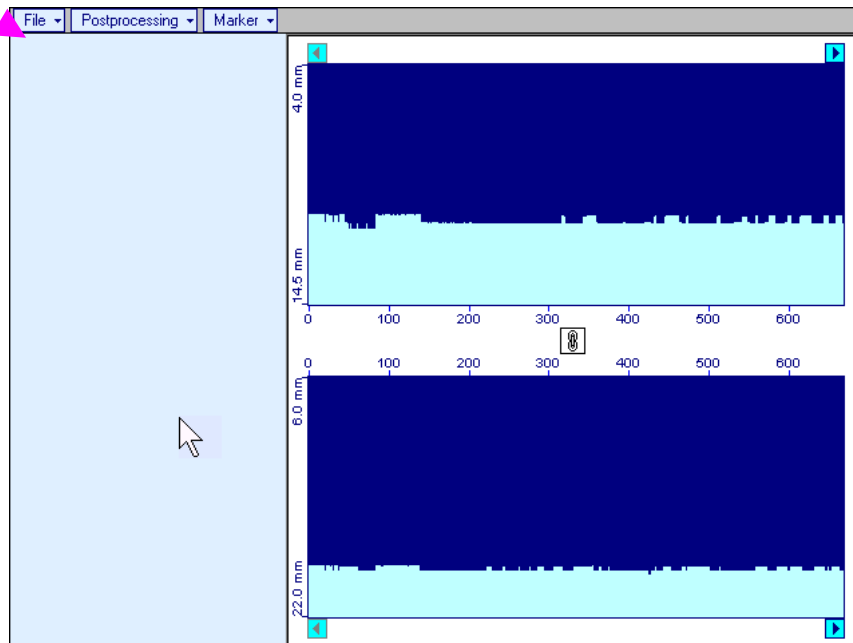

## 7.2.3. Postprocessing

The screen as below appears upon opening file. All postprocessing procedures are performed through **menu bar** – touch screen stylus or front panel or external mouse to be used





### Menu Bar Functions

- **File→Print** – prints out dual channel **BScan(Th)** image
- **File→Exit** – returns to **Main Recording Menu - Dual Channel**

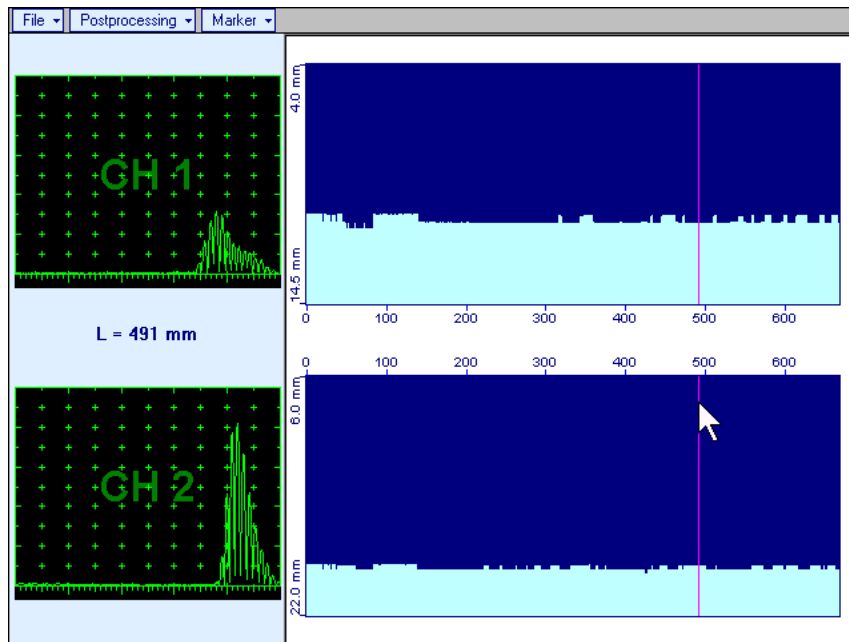
- Marker→ADD** – generates *cursor representing sound path* of probes central beams in the object under test that may be guided over dual channel **BScan(Th)** image using either touch screen stylus or mouse or ,  on front panel keyboard or ,  on external keyboard – corresponding **A-Scans** are recovered synchronously according to *sound path cursor* position





To fix position of *sound path cursor* with corresponding recovered **A-Scan** left mouse click or release touch screen stylus or press  on front panel keyboard or **Enter** on external keyboard

To interrupt recovery of **A-Scans** and empty **A-Scans Recovery** field right mouse click or press  on front panel keyboard or **Esc** on external keyboard

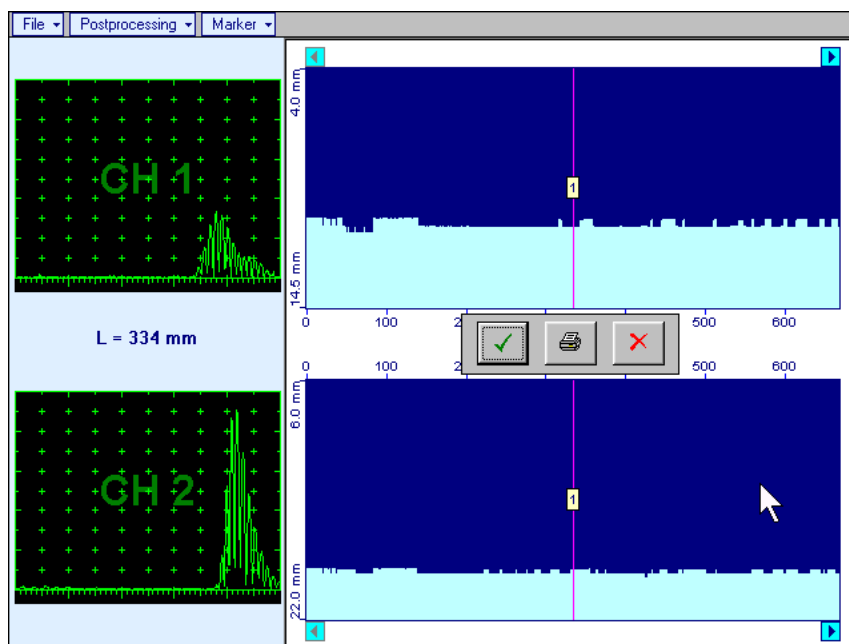
Double click on fixed marker number will cause appearance of both related **A-Scans** and generating of pop up controls:



- clicking on  will print out dual channel **BScan(Th)** image with marker on it and related **A-Scans** then close pop up controls and related **A-Scans**

- clicking on  will close popup controls and related **A-Scans**
- clicking on  will erase marker and close popup controls and related **A-Scans**

To interrupt recovery of **A-Scans** and empty **A-Scan Recovery** field right mouse click or press on front panel keyboard or  on external keyboard

- **Marker→ADD→Clear Last** – erases last fixed marker
- **Marker→ADD→Clear All** – erases all fixed markers
- **Postprocessing→CH 1** – zooms **BScan(Th)** record of the *first channel* and initiates comprehensive postprocessing procedure – refer to paragraph 6.3.2.5 of present Operating Manual to get fully instructed
- **Postprocessing→CH 2** – zooms **BScan(Th)** record of the *first channel* and initiates comprehensive postprocessing procedure – refer to paragraph 6.3.2.5 of present Operating Manual to get fully instructed

## 7.3. Dual Channel TOFD Inspection – RF B-Scan and D-Scan Imaging and Recording

### 7.3.1. Setting Pulser Receiver Channels

Each channel must be calibrated prior to entering **Main Recording Menu for Dual Channel Mode** according to paragraph 6.5.1 of present Operating Manual

### 7.3.2. Pre-Scanning Settings

#### Scan Length

*Scan Length* – **Length** represents length of scanning line over section of test object to be displayed

The screenshot shows the 'TOFD Inspection Setup' menu with the following settings:

- 200 Length**: 1190 mm (highlighted in white)
- 2 CH1 Base**: 114 mm
- 1 CH2 Base**: 114 mm
- 2 Displacement**: 84 mm
- Averaging**: 2
- Encoder**: Default

Callouts from the image:

- Current value of Length mm or in**: Points to the '200 Length' field.
- Current value of increment/decrement for Length setup, mm or in**: Points to the '1' in the increment/decrement field.
- Click on this button or press [1] on front panel keyboard or F1 or <Alt>+<1> on external keyboard to select value of increment/decrement for Length setting**: Points to the increment/decrement field.

To control **Length** the following manipulations are applicable:

- **Mouse / Touch Screen**
  - Click on corresponding **button**
- **Keyboard**
  - Press on front panel keyboard or **F1** on external keyboard ⇒ **Length** fore color changes to white - then use , , , on front panel keyboard or , , , on external keyboard
- **Combined**
  - Click on **Length** ⇒ **Length** fore color changes to white - then use , , , on front panel keyboard or , , , on external keyboard



The value of **Length** is adjustable between 50 and 20000 **mm** or 2 and 800 **in**

## CH 1 Base

CH 1 Base represents Probe Separation for Channel 1

The screenshot shows the 'TOFD Inspection Setup' menu with the following parameters and their current values:

- 200 Length: 1190 mm
- 2 CH1 Base: 114 mm
- 1 CH2 Base: 114 mm
- 2 Displacement: 84 mm
- Averaging: 2

Each parameter has a set of navigation buttons (left arrow, up/down arrows, right arrow) and a numeric keypad button (1-5). The '2 CH1 Base' parameter is highlighted in white, indicating it is the active parameter.

Callouts provide the following information:

- Current value of CH 1 Base mm or in**: Points to the '114 mm' value.
- Current value of increment/decrement for CH 1 Base setup, mm or in**: Points to the '2' value in the numeric keypad button.
- Click on this button or press  $\uparrow$  2 on front panel keyboard or F2 or <Alt>+<2> on external keyboard to select value of increment/decrement for CH 1 Base setting**: Points to the numeric keypad button '2'.

To control CH 1 Base the following manipulations are applicable:

- **Mouse / Touch Screen**

- Click on corresponding button

- **Keyboard**

- Press  $\uparrow$  2 on front panel keyboard or F2 on external keyboard  $\Rightarrow$  CH 1 Base fore color changes to white - then use  $\uparrow$ ,  $\rightarrow$ ,  $\leftarrow$ ,  $\downarrow$  on front panel keyboard or  $\uparrow$ ,  $\rightarrow$ ,  $\leftarrow$ ,  $\downarrow$  on external keyboard

- **Combined**

- Click on CH 1 Base  $\Rightarrow$  CH 1 Base fore color changes to white - then use  $\uparrow$ ,  $\rightarrow$ ,  $\leftarrow$ ,  $\downarrow$  on front panel keyboard or  $\uparrow$ ,  $\rightarrow$ ,  $\leftarrow$ ,  $\downarrow$  on external keyboard



The value of CH 1 Base is adjustable between 25 and 500 mm or 1 and 20 in



## CH 2 Base

CH 2 Base represents **Probe Separation** for Channel 2

The screenshot shows the 'TOFD Inspection Setup' menu with the following parameters:

- 200 Length: 1190 mm
- 2 CH1 Base: 114 mm
- 1 CH2 Base: 114 mm (highlighted)
- 2 Displacement: 84 mm
- Averaging: 2

Encoder: Default

Buttons: < Back, Next >

Callout boxes:

- Top: Current value of increment/decrement for CH 2 Base setup, mm or in
- Left: Current value of CH 2Base mm or in
- Right: Click on this button or press on front panel keyboard or **F3** or **<Alt>+<3>** on external keyboard to select value of increment/decrement for CH 2 Base setting

To control **CH 2 Base** the following manipulations are applicable:

- **Mouse / Touch Screen**

- Click on corresponding button

- **Keyboard**

- Press on front panel keyboard or **F3** on external keyboard ⇒ **CH 2 Base** fore color changes to white - then use , , , on front panel keyboard or , , , on external keyboard

- **Combined**

- Click on **CH 2 Base** ⇒ **CH 2 Base** fore color changes to white - then use , , , on front panel keyboard or , , , on external keyboard



The value of **CH 2 Base** is adjustable between 25 and 500 **mm** or 1 and 20 **in**

## Displacement

**Displacement** represents **Distance between two TOFD probes pair along the scanning line**; entering of displacement is necessary to obtain **Aligned Dual channel TOFD Map**

The screenshot shows the 'TOFD Inspection Setup' menu with the following settings:

- 200 Length: 1190 mm
- 2 CH1 Base: 114 mm
- 1 CH2 Base: 114 mm
- 2 Displacement: 84 mm
- Averaging: 2
- Encoder: Default

Callouts provide the following information:

- Current value of increment/decrement for Displacement setup, mm or in**: Points to the increment/decrement buttons (1, 2, 3, 4, 5) next to each setting.
- Click on this button or press on front panel keyboard or **F4** or **<Alt>+<4>** on external keyboard to select value of increment/decrement for Displacement setting**: Points to the button with the number 4 and an arrow icon.
- Current value of Displacement mm or in**: Points to the '2 Displacement 84 mm' setting.

To control **Displacement** the following manipulations are applicable:

- **Mouse / Touch Screen**
  - Click on corresponding **button**
- **Keyboard**
  - Press on front panel keyboard or **F4** on external keyboard ⇒ **Displacement** fore color changes to white - then use , , , on front panel keyboard or , , , on external keyboard
- **Combined**
  - Click on **Displacement** ⇒ **Displacement** fore color changes to white - then use , , , on front panel keyboard or , , , on external keyboard



The value of **Displacement** is adjustable between -100 and +100 mm or -4 and +4 in

## Averaging

Sometimes **Averaging** of sequential **A-Scans** is required to improve signal to noise ratio of **TOFD** records

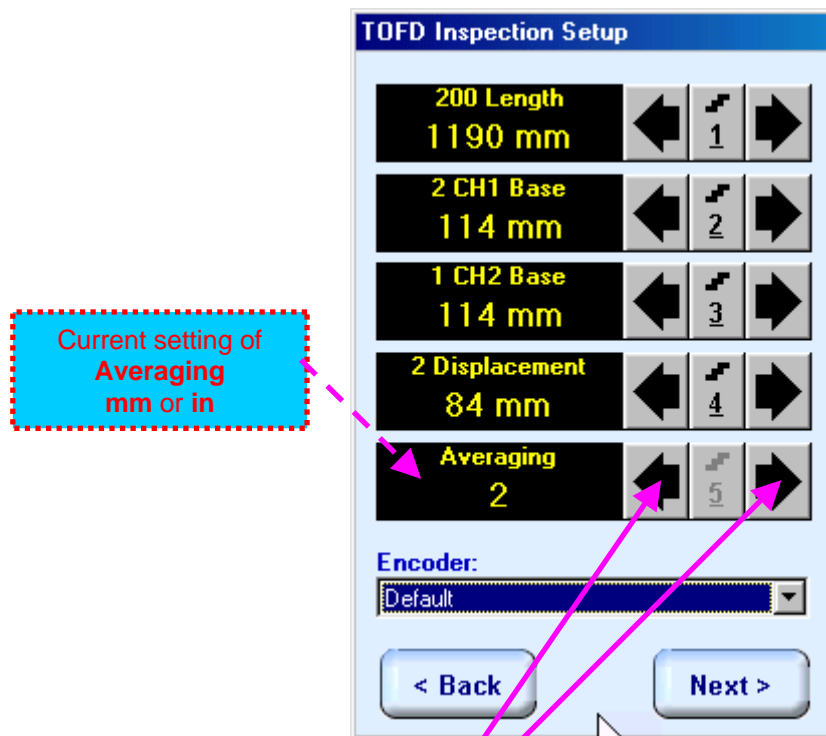









To control **Averaging** the following manipulations are applicable:









- **Mouse / Touch Screen**

- Click on corresponding **button**

- **Keyboard**

- Press  on front panel keyboard or **F5** on external keyboard ⇒ **Averaging** fore color changes to white - then use , , ,  on front panel keyboard or , , ,  on external keyboard

- **Combined**

- Click on **Averaging** ⇒ **Averaging** fore color changes to white - then use , , ,  on front panel keyboard or , , ,  on external keyboard



**Averaging** may be either inactive (1) or active with factor 2, 4, or 8

## Encoder

Select encoder to be used through appropriate box



Connect encoder to its input on the rear panel of **ISONIC 2007** instrument

### Return to Main Recording Menu - Dual Channel

Click on  or press  on front panel keyboard or **Esc** on external keyboard to return to **Main Recording Menu - Dual Channel**

### Start Scanning



Click on  or press  on front panel keyboard or **F8** on external keyboard to proceed to **Dual Channel TOFD Scanning**

## 7.3.3. Scanning

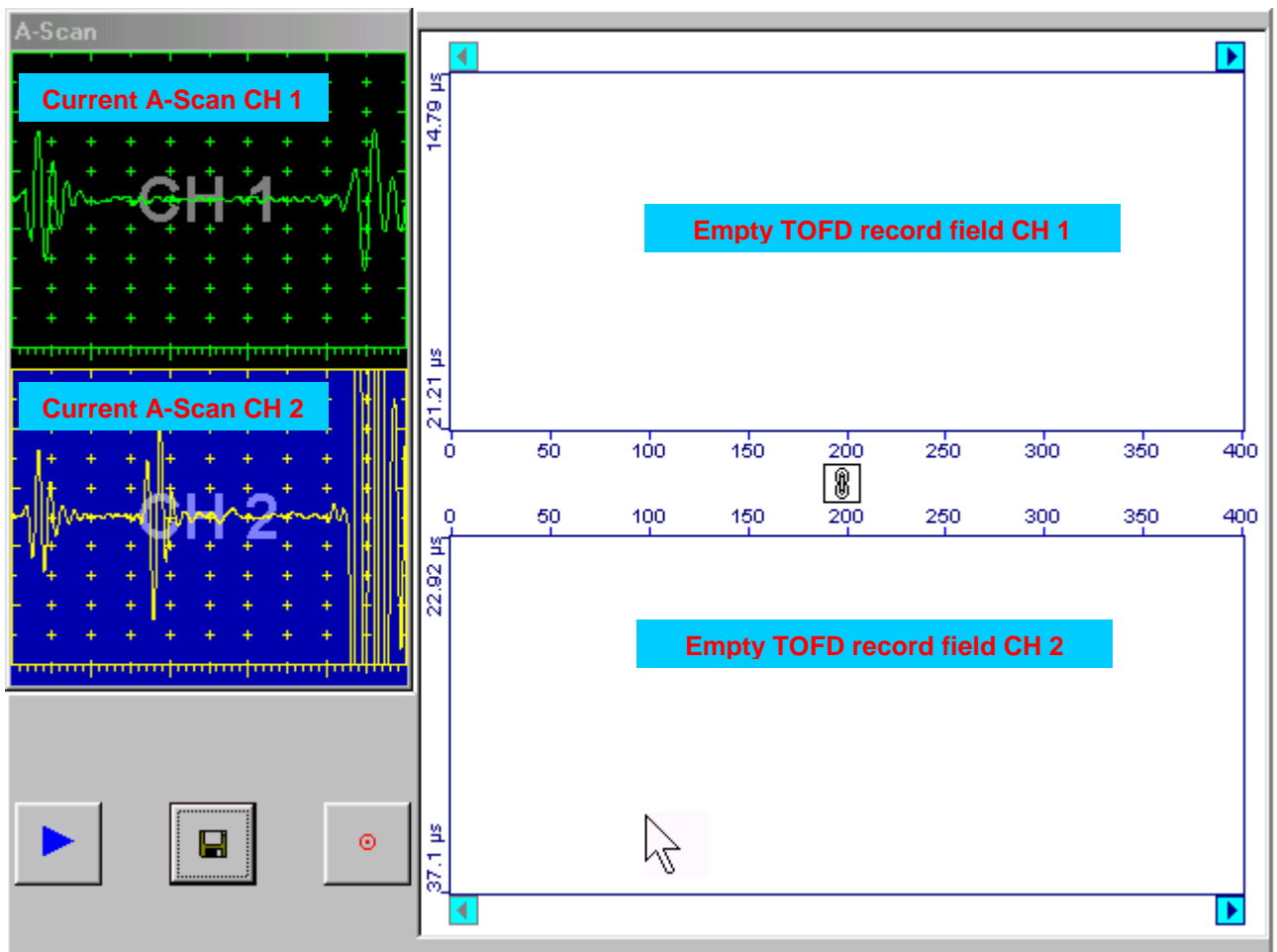
Dual channel **Dual Channel TOFD Scanning** control panel is shown below









### Scrolling Dual Channel TOFD record fields



The scrolling is possible through clicking on  and  buttons. It is possible to scroll first and second channel images synchronously or separately from each other, mode of scrolling is defined through clicks on

 /  button

### Start/Stop Dual Channel TOFD recording



Click on  or press  on front panel keyboard or **F8** on external keyboard to start **TOFD** recording

 button becomes invisible since **TOFD** recording starts.  button occupies its position. Click on  or press  on front panel keyboard or **F8** or **<Alt>+<S>** on external keyboard to terminate **TOFD** recording

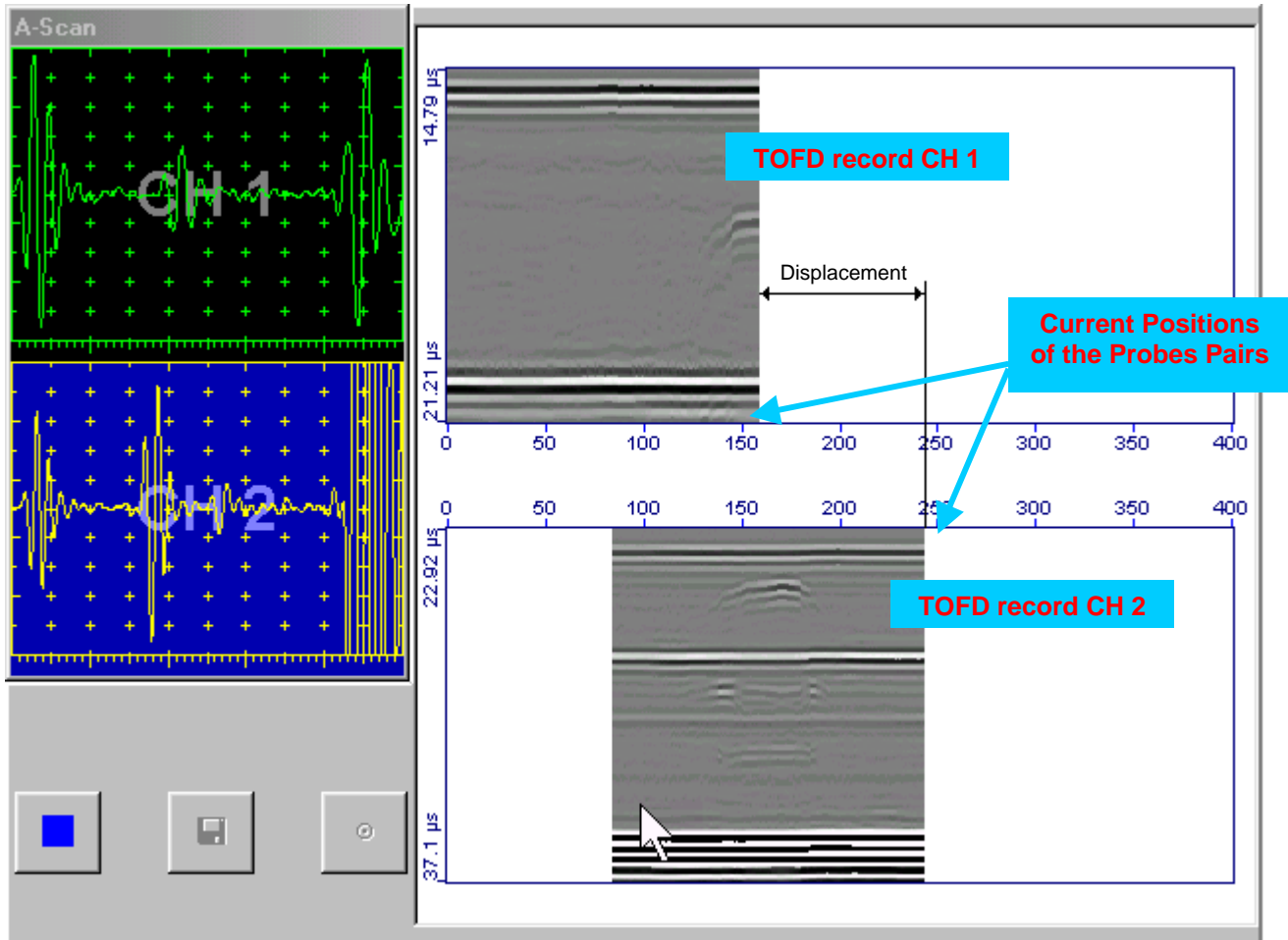

 button becomes invisible after termination of **TOFD** record.  button returns to its position  
Typical screen during dual channel **TOFD** recording is presented below:



### Save record into a file

Click on  or press  on front panel keyboard or **F12** on external keyboard to save captured **Dual Channel TOFD** record accompanied with instrument calibration dump and text notes / comments into a file. Refer to paragraph 5.2.17 of this Operating Manual to proceed with file saving

### Return to Pre-Scanning Settings Menu

Click on  or press  on front panel keyboard or **ESC** on external keyboard to return to **Pre-Scanning Settings Menu**



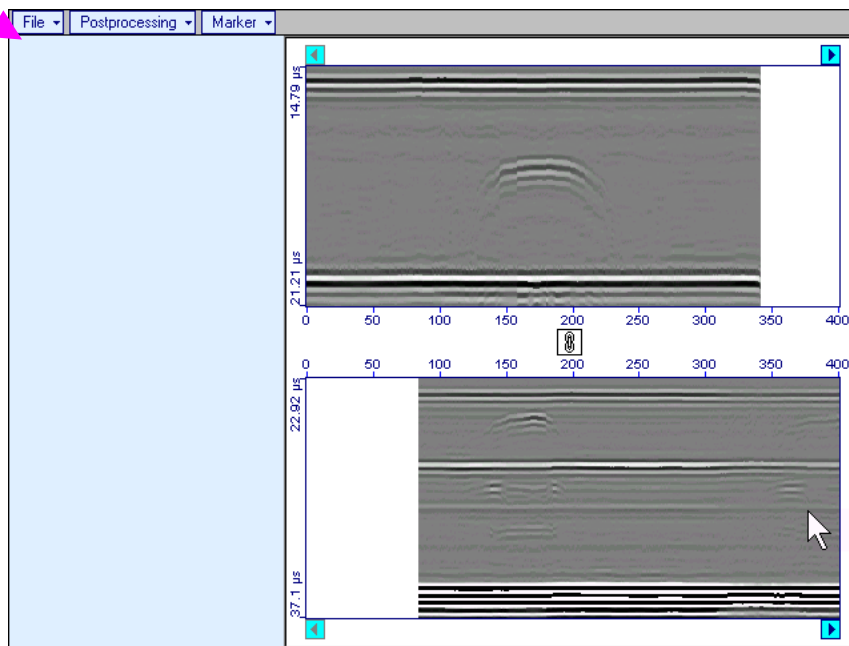

### 7.3.4. Postprocessing

The screen as below appears upon opening file. All postprocessing procedures are performed through **menu bar** – touch screen stylus or front panel or external mouse to be used





#### Menu Bar Functions

- **File→Print** – prints out dual channel TOFD image
- **File→Exit** – returns to **Main Recording Menu - Dual Channel**

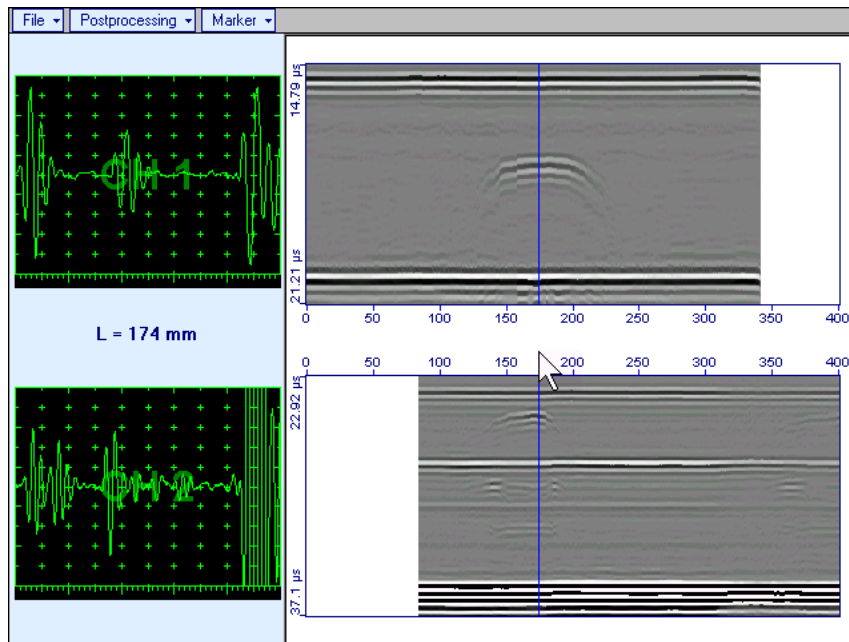
- Marker→ADD** – generates *cursor representing sound path* of probes central beams in the object under test that may be guided over dual channel **TOFD** image using either touch screen stylus or mouse or  ,  on front panel keyboard or  ,  on external keyboard – corresponding **A-Scans** are recovered synchronously according to *sound path cursor* position





To fix position of *sound path cursor* with corresponding recovered **A-Scan** left mouse click or release touch screen stylus or press  on front panel keyboard or **Enter** on external keyboard

To interrupt recovery of **A-Scans** and empty **A-Scans Recovery** field right mouse click or press  on front panel keyboard or **Esc** on external keyboard

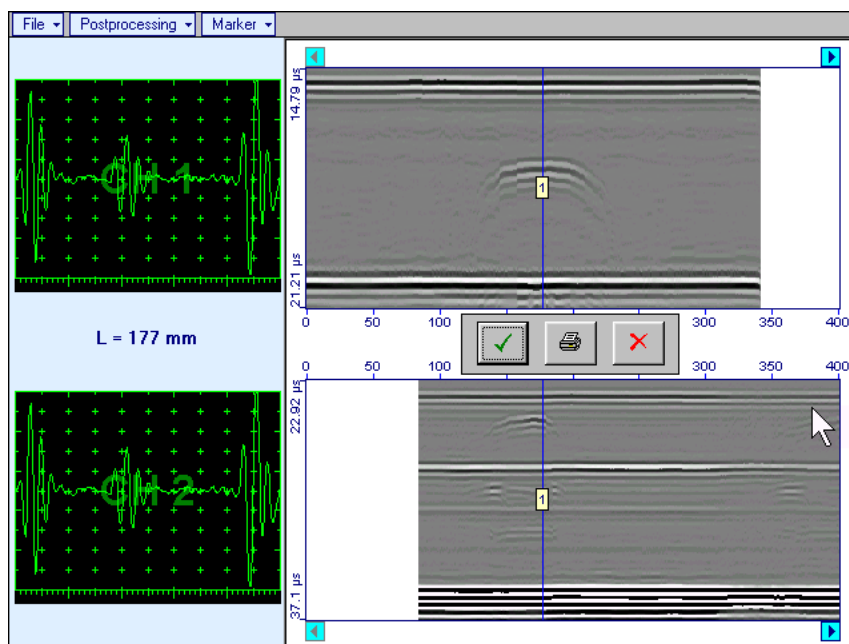
Double click on fixed marker number will cause appearance of both related **A-Scans** and generating of popup controls:



- clicking on  will print out dual channel **TOFD** image with marker on it and related **A-Scans** then close popup controls and related **A-Scans**

- clicking on  will close popup controls and related **A-Scans**
- clicking on  will erase marker and close popup controls and related **A-Scans**

To interrupt recovery of **A-Scans** and empty **A-Scan Recovery** field right mouse click or press on front panel keyboard or  on external keyboard

- **Marker→ADD→Clear Last** – erases last fixed marker
- **Marker→ADD→Clear All** – erases all fixed markers
- **Postprocessing→CH 1** – zooms **TOFD** record of the *first channel* and initiates comprehensive postprocessing procedure – refer to paragraph 6.5.2.5 of present Operating Manual to get fully instructed
- **Postprocessing→CH 2** – zooms **TOFD** record of the *first channel* and initiates comprehensive postprocessing procedure – refer to paragraph 6.5.2.5 of present Operating Manual to get fully instructed



## 7.4. CB-Scan horizontal plane-view imaging and recording of defects for shear, surface, and guided wave inspection – FLOORMAP L

### 7.4.1. Setting Pulser Receiver Channels

Each channel must be calibrated prior to entering **Main Recording Menu for Dual Channel Mode** according to paragraph 6.6.1 of present Operating Manual







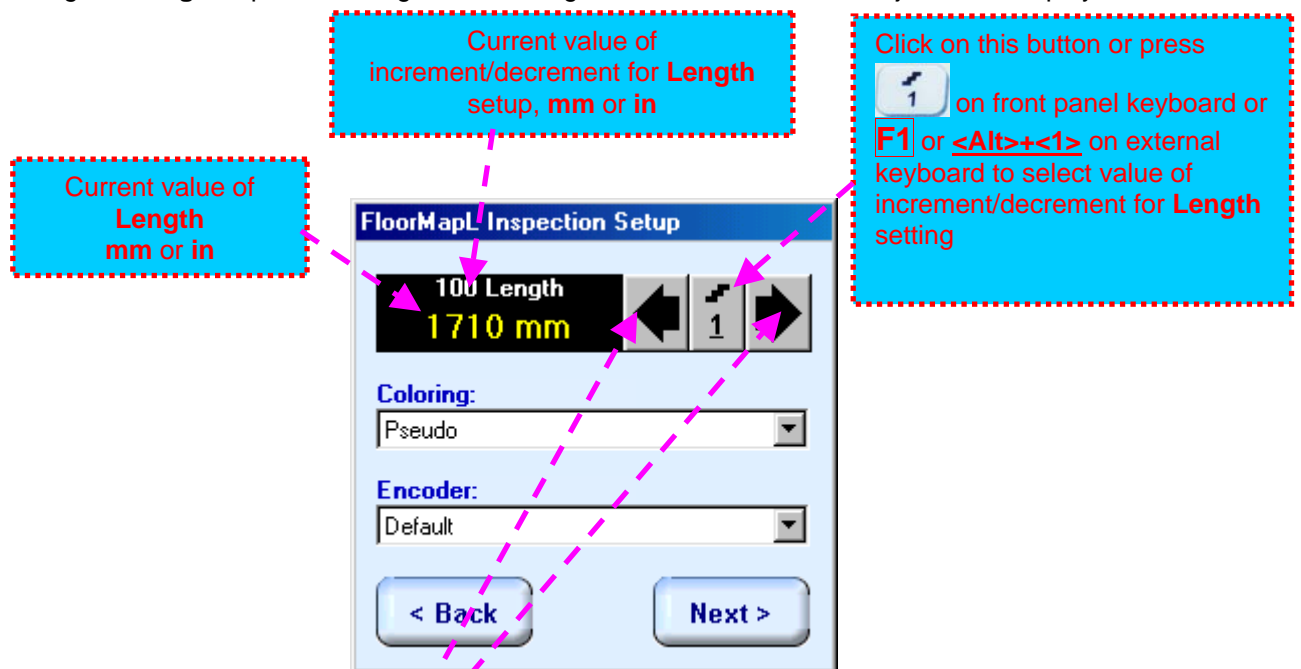









### 7.4.2. Pre-Scanning Settings

#### Scan Length

*Scan Length* – **Length** represents length of scanning line over section of test object to be displayed



To control **Length** the following manipulations are applicable:

- **Mouse / Touch Screen**
  - Click on corresponding **button**
- **Keyboard**
  - Press  on front panel keyboard or **F1** on external keyboard ⇒ **Length** fore color changes to white - then use , , ,  on front panel keyboard or , , ,  on external keyboard
- **Combined**
  - Click on **Length** ⇒ **Length** fore color changes to white - then use , , ,  on front panel keyboard or , , ,  on external keyboard



The value of **Length** is adjustable between 50 and 20000 **mm** or 2 and 800 **in**

### **CB-Scan (FLOORMAP L) Record Palette**

There are four palettes available through – select through



### **Encoder**

Select encoder to be used through appropriate box

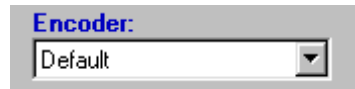



Connect encoder to its input on the rear panel of **ISONIC 2007** instrument

### **Return to Main Recording Menu - Dual Channel**

Click on  or press  on front panel keyboard or **Esc** on external keyboard to return to **Main Recording Menu - Dual Channel**

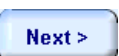
### **Start Scanning**



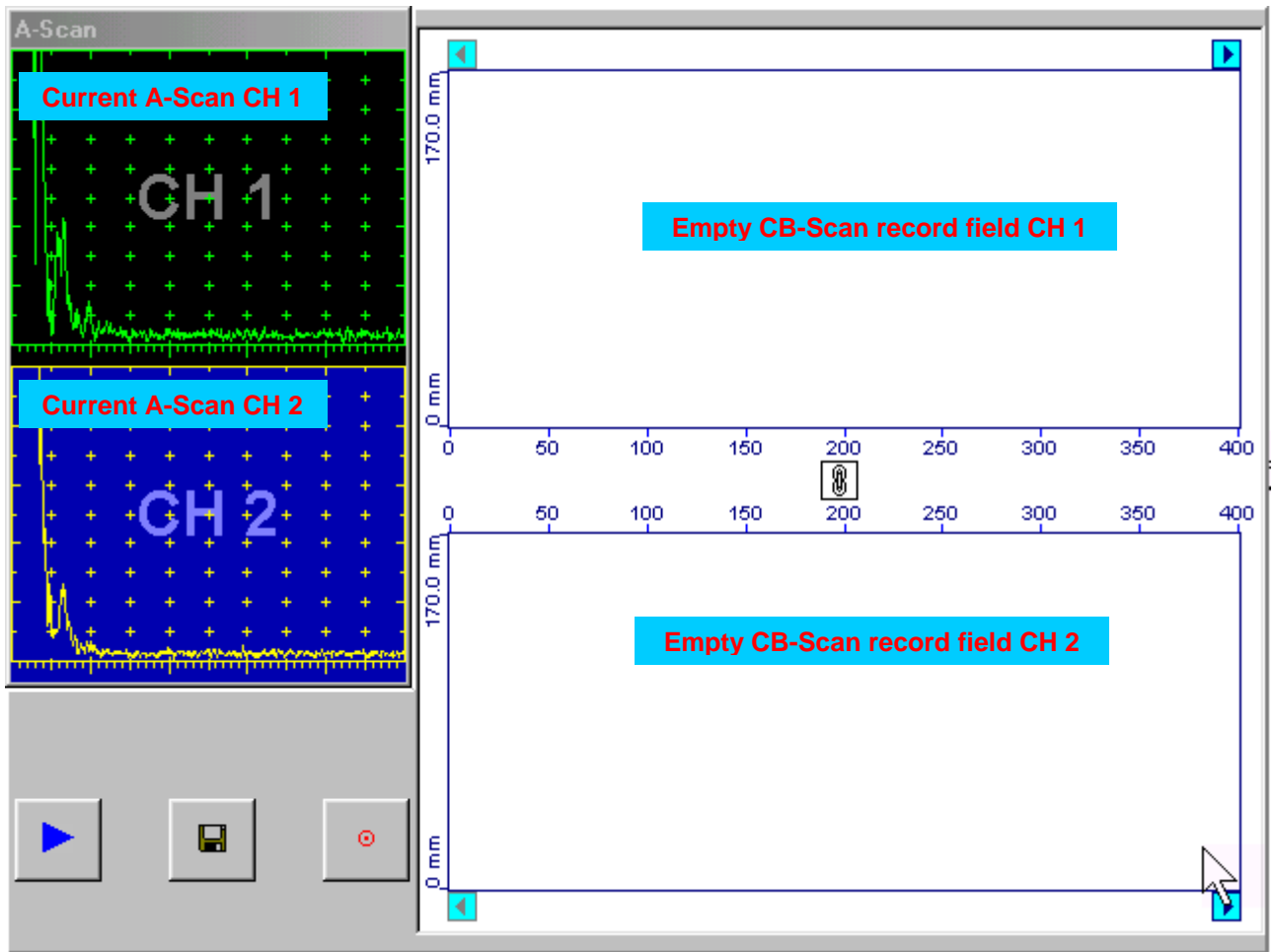

Click on  or press  on front panel keyboard or **F8** on external keyboard to proceed to **Dual Channel CB-Scan (FLOORMAP L) Recording**

### 7.4.3. Scanning



Dual channel **Dual Channel CB-Scan (FLOORMAP L) Recording** control panel is shown below







#### Scrolling Dual Channel CB-Scan (FLOORMAP L) record fields

The scrolling is possible through clicking on  and  buttons. It is possible to scroll first and second channel images synchronously or separately from each other, mode of scrolling is defined through clicks on  /  button

### Start/Stop Dual Channel CB-Scan (FLOORMAP L) recording

Click on  or press  on front panel keyboard or **F8** on external keyboard to start **CB-Scan (FLOORMAP L)** recording



 button becomes invisible since **CB-Scan (FLOORMAP L)** recording starts.  button occupies its position. Click on  or press  on front panel keyboard or **F8** or **<Alt>+<S>** on external keyboard to terminate **CB-Scan (FLOORMAP L)** recording

 button becomes invisible after termination of **CB-Scan (FLOORMAP L)** record.  button returns to its position

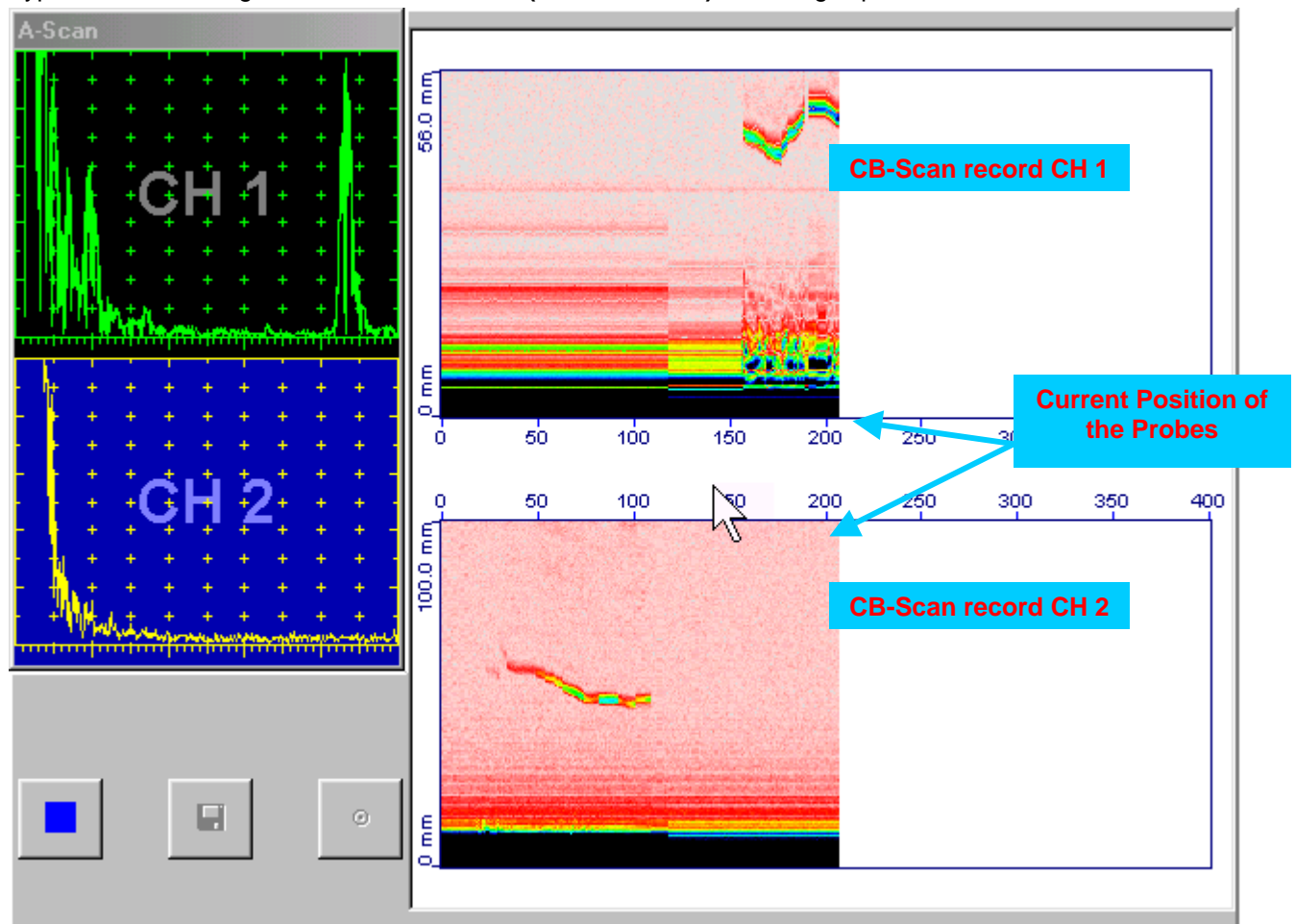

Typical screen during dual channel **CB-Scan (FLOORMAP L)** recording is presented below:



### Save record into a file

Click on  or press  on front panel keyboard or **F12** on external keyboard to save captured **Dual Channel CB-Scan (FLOORMAP L)** record accompanied with instrument calibration dump and text notes / comments into a file. Refer to paragraph 5.2.17 of this Operating Manual to proceed with file saving

### Return to Pre-Scanning Settings Menu

Click on  or press  on front panel keyboard or **ESC** on external keyboard to return to **Pre-Scanning Settings Menu**



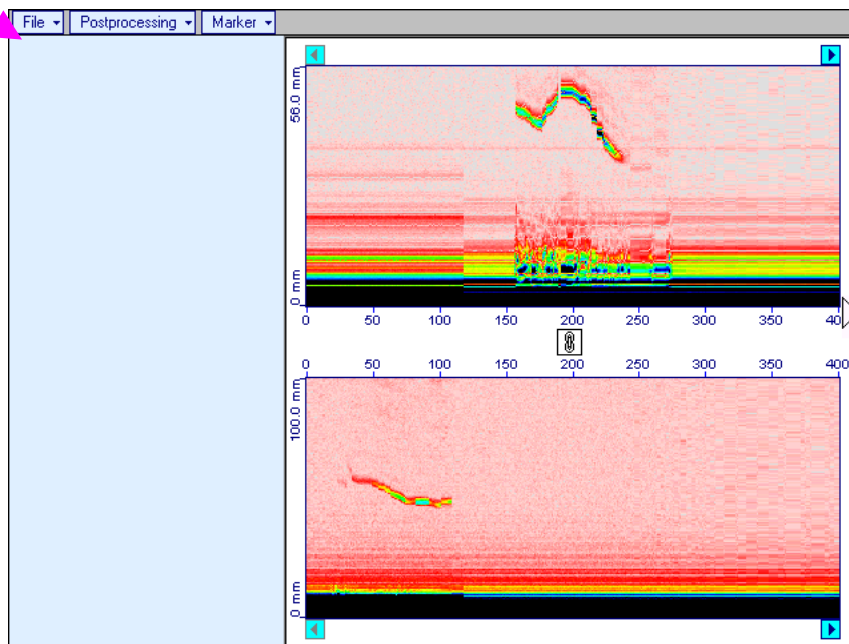

## 7.4.4. Postprocessing

The screen as below appears upon opening file. All postprocessing procedures are performed through **menu bar** – touch screen stylus or front panel or external mouse to be used





### Menu Bar Functions

- **File→Print** – prints out dual channel **CB-Scan (FLOORMAP L)** image
- **File→Exit** – returns to **Main Recording Menu - Dual Channel**

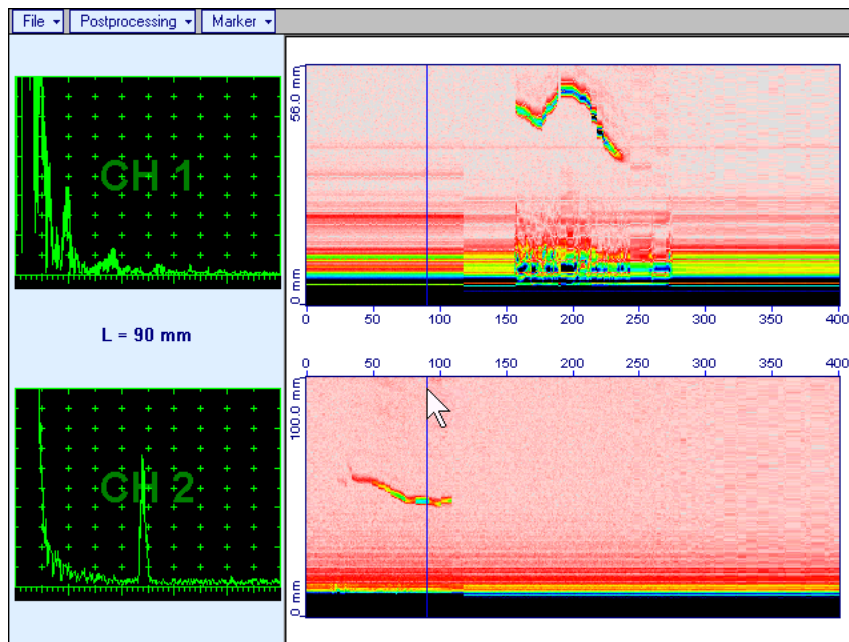
- Marker→ADD** – generates *cursor representing sound path* of probes central beams in the object under test that may be guided over dual channel **CB-Scan (FLOORMAP L)** image using either touch screen stylus or mouse or   on front panel keyboard or   on external keyboard – corresponding **A-Scans** are recovered synchronously according to *sound path cursor* position





To fix position of *sound path cursor* with corresponding recovered **A-Scan** left mouse click or release touch screen stylus or press  on front panel keyboard or **Enter** on external keyboard

To interrupt recovery of **A-Scans** and empty **A-Scans Recovery** field right mouse click or press  on front panel keyboard or **Esc** on external keyboard

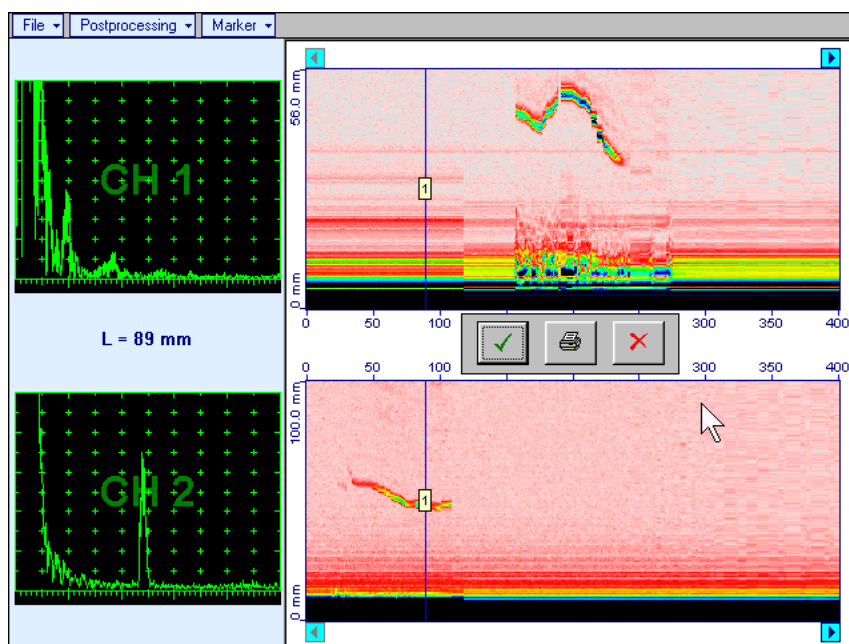
Double click on fixed marker number will cause appearance of both related **A-Scans** and generating of popup controls:



- clicking on  will print out dual channel **CB-Scan (FLOORMAP L)** image with marker on it and related **A-Scans** then close popup controls and related **A-Scans**

- clicking on  will close popup controls and related **A-Scans**
- clicking on  will erase marker and close popup controls and related **A-Scans**

To interrupt recovery of **A-Scans** and empty **A-Scan Recovery** field right mouse click or press on front panel keyboard or  on external keyboard

- **Marker→ADD→Clear Last** – erases last fixed marker
- **Marker→ADD→Clear All** – erases all fixed markers
- **Postprocessing→CH 1** – zooms **CB-Scan (FLOORMAP L)** record of the *first channel* and initiates comprehensive postprocessing procedure – refer to paragraph 6.6.2.5 of present Operating Manual to get fully instructed
- **Postprocessing→CH 2** – zooms **CB-Scan (FLOORMAP L)** record of the *first channel* and initiates comprehensive postprocessing procedure – refer to paragraph 6.6.2.5 of present Operating Manual to get fully instructed

# 8. Incremental Encoders



## 8.1. Standard Encoder SK 2001108 ABI – Single Channel Operation

Encoder **SK 2001108 ABI** is originally designed for **BScan(Th)** and **ABIScan** recording with **ISONIC 2001**, **ISONIC 2005**, **ISONIC 2006**, **ISONIC 2007**, **ISONIC 2008** instruments – single channel operation

To start use of the encoder refer to simple guidance as below

### Step 1

Fit probe into appropriate probe holder and connect signal cable(s) to probe



### Step 2

Fit probe holder with probe into encoder



### Step 3

Connect probe signal cable(s) to appropriate coaxial socket on **ISONIC 2007** instrument – refer to paragraph 4.2 of this Operating Manual

Connect encoder data cable to the appropriate D-Type connector on rear panel of **ISONIC 2007** instrument – refer to paragraph 4.2 of this Operating Manual

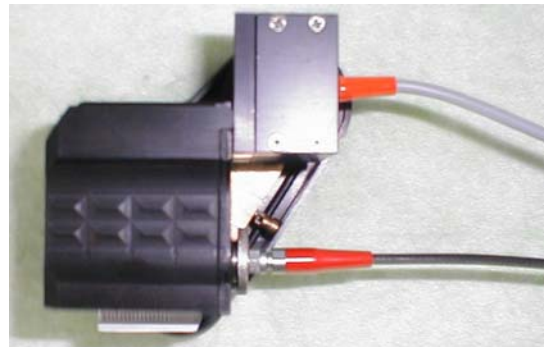

# 8.2. Standard Encoder SK 2001108 FM – Single Channel Operation

Encoder **SK 2001108 FM** is originally designed for **TOFD** and **FLOORMAP L** recording with **ISONIC 2001**, **ISONIC 2005**, **ISONIC 2006**, **ISONIC 2007**, **ISONIC 2008** instruments – single channel operation. To start use of the encoder refer to simple guidance as below

## 8.2.1. TOFD

Insert ultrasonic probes into their probe holders then:

- ❑ Fit probe holders with probes on **TOFD** bar and fix them at at necessary separation distance
- ❑ Fix twister **S 904050** on the **TOFD** bar
- ❑ Fit encoder **SK 2001108 FM** into twister **S 904050** and provide necessary orientation of encoder's wheel – it must be oriented at parallel to the desired probes' trace either along or across the weld – refer to the sketch and photos below

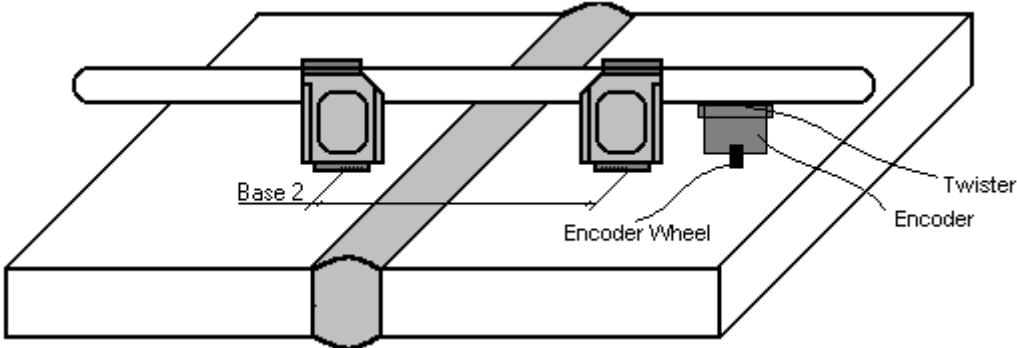

**TOFD** Fixture and encoder positioning for scanning along the weld

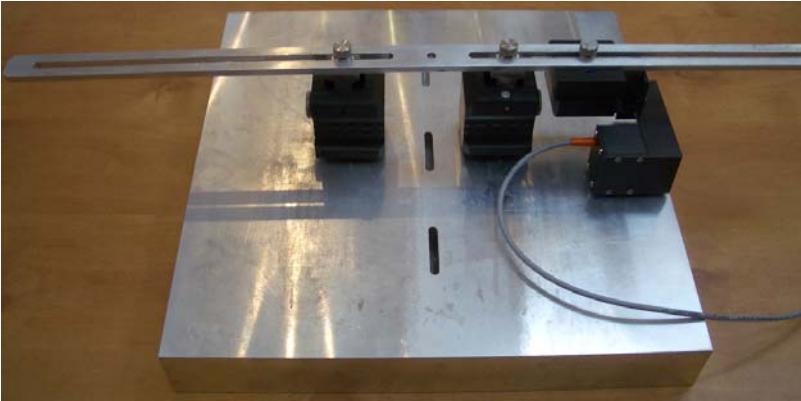

**TOFD** Fixture and encoder positioning for scanning across the weld

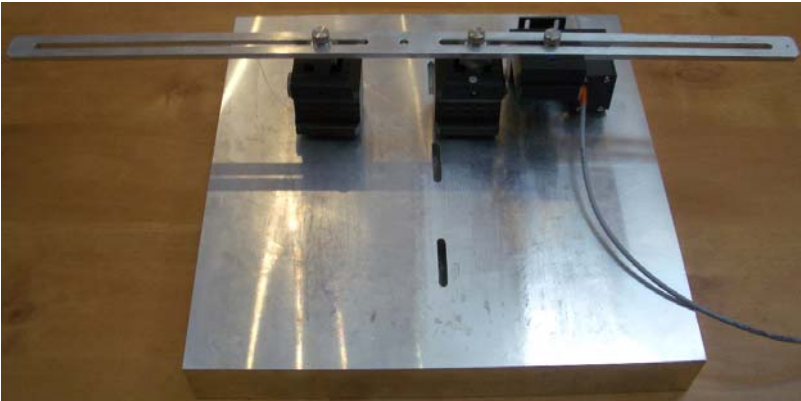



### 8.2.2. FLOORMAP L

Encoder **SK 2001108 FM** allows 2 ways of direct fitting of S 544 series guided wave probes or other probes fitted into appropriate probe holders:

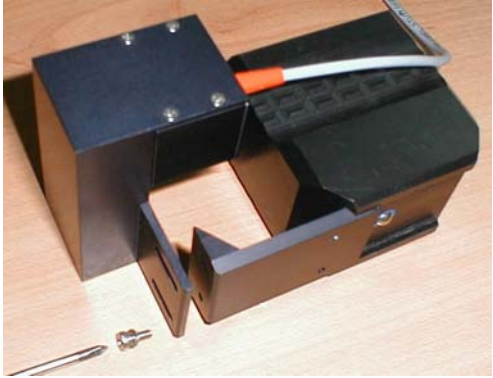
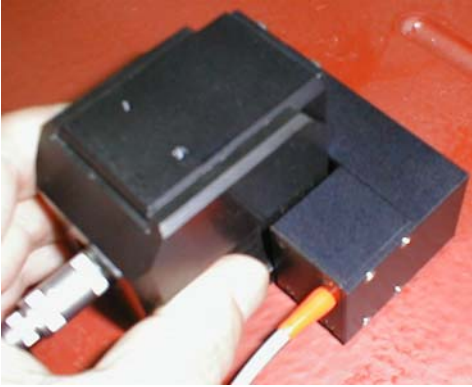
- Both encoder's wheel and probe contact face are situated on scanning surface:

| Fitting probe into encoder  | Ready to scan  |
|---|--|
|  |  |

- Encoder's wheel is situated on surface, which is rectangular to scanning surface:

| Fitting probe into encoder  | Ready to scan  |
|---|--|
|  |  |

## 8.3. Customized Encoders for Proprietary Inspection Tasks – Single and Dual Channel Operation

Various custom made encoders for proprietary inspection tasks may be used with **ISONIC 2007**. For appropriate encoder data cable and connector pin-out contact

- ❑ Nearest Sonotron NDT representative

OR

- ❑ Directly to Sonotron NDT – mail to [support@sonotronndt.com](mailto:support@sonotronndt.com) with subject **ISONIC 2007 encoder connection**



**Improper cable out-coming from custom made encoder for proprietary inspection tasks may lead to warranty exempted damaging ISONIC 2007 instrument**

## 8.4. Encoder Calibration

Every encoder to be calibrated prior to use with **ISONIC 2007**





To proceed with the calibration in the **ISONIC 2007 start screen** **click on** or press  on front panel keyboard or **F2** on external keyboard

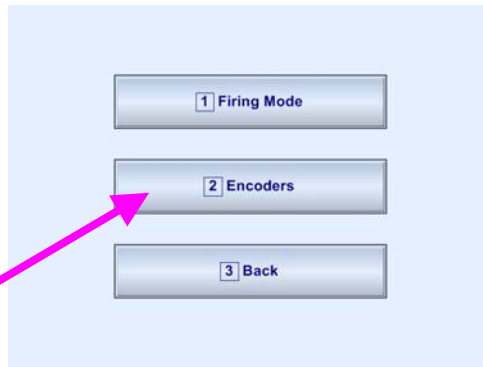

In the appeared **ISONIC 2007 Settings Menu** **click on** or press  on front panel keyboard or **F3** on external keyboard



Then **click on** or press 

To calibrate encoder or press  or **click on**

To select encoder increment press  or **click on**

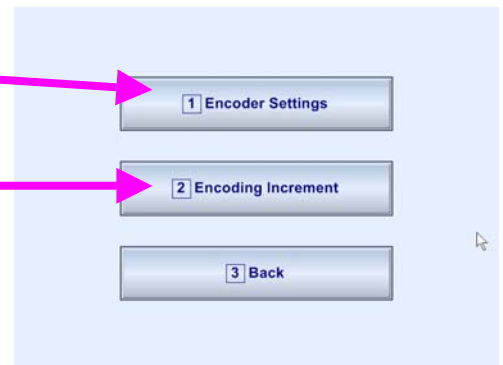

### **Encoder Calibration Procedure**

In the appeared **ISONIC Encoder Settings** window **click on** or press **<Alt>+<A>** on external keyboard

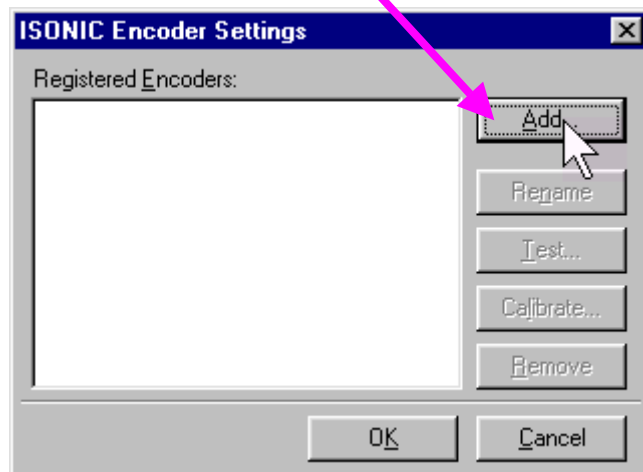

The **Calibrate Encoder** window appears; it contains simple instructions to follow:

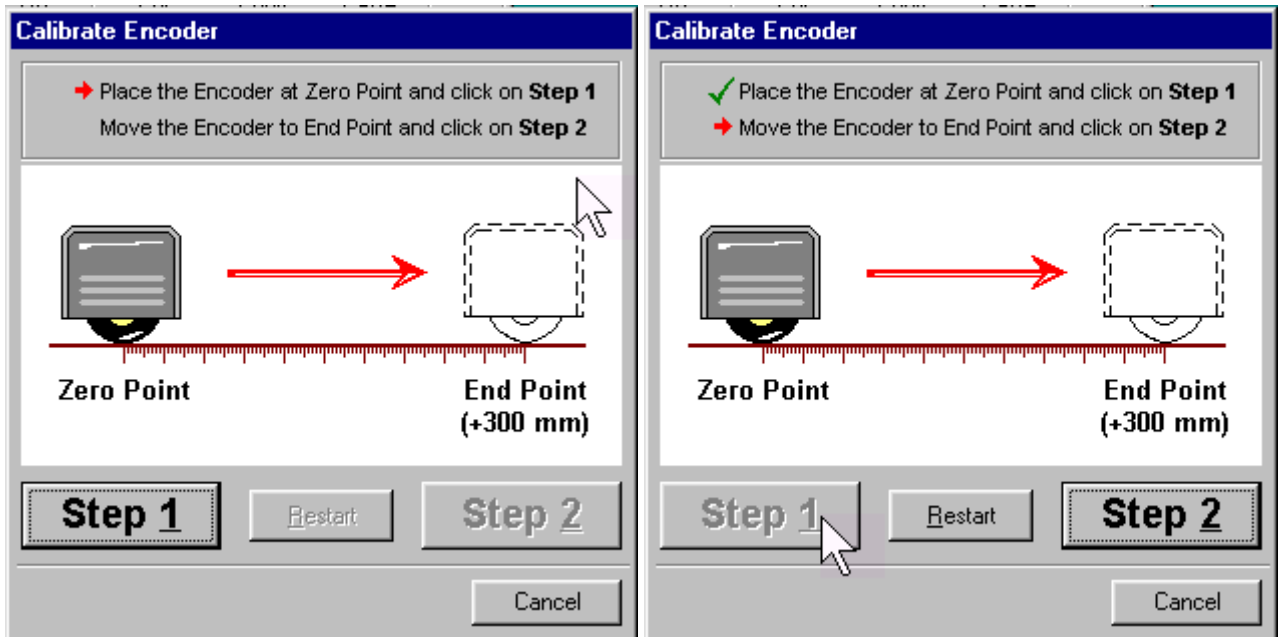



Encoder's wheel while calibrating must pass linearly the distance of **300 mm (12 in)** between **Zero Point** designated through clicking on **Step 1** or pressing **<Alt>+<1>** on external keyboard and **End Point** along scale bar attached to flat surface

Upon reaching **End Point** and clicking on **Step 2** or pressing **<Alt>+<2>** on external keyboard new **Encoder Test** window appears



If it's necessary to re-designate **Zero Point** click on **Restart** or press **<Alt>+<R>** on external keyboard

In the **Encoder Test** window:

- ❑ Click on **Reset** or press **<Alt>+<R>** on external keyboard to designate **local zero point** for continuing test
- ❑ Click on **Yes** or press  on front panel keyboard or **Enter** or **<Alt>+<Y>** on external keyboard to name the selected encoder – **Key in the Encoder Name window** appears
- ❑ Click on **No** or press  on front panel keyboard or press **Esc** or **<Alt>+<N>** on external keyboard to recalibrate the encoder – return to **Calibrate Encoder window**

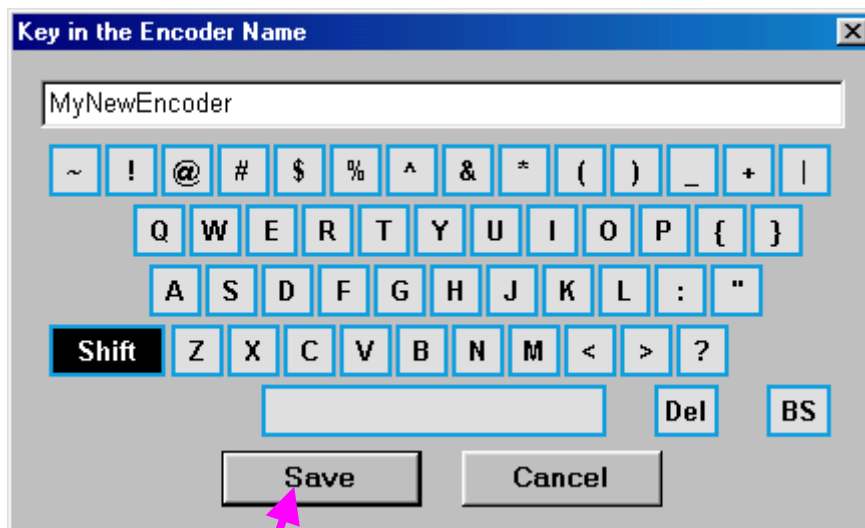
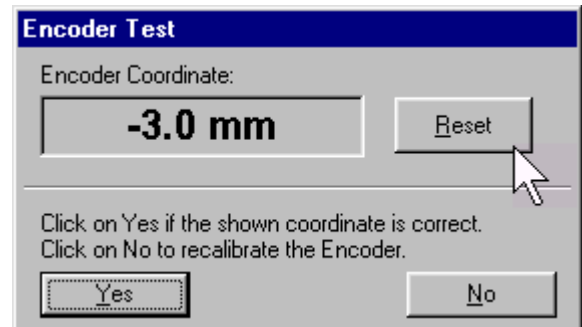

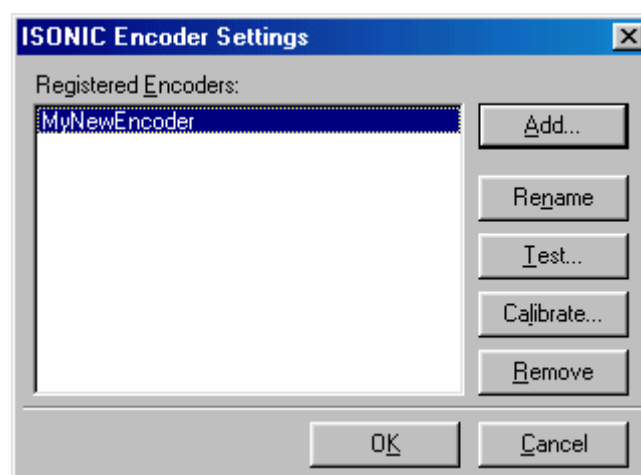

Upon keying in new Encoder name **click on** **ISONIC Encoder Settings** window returns upon

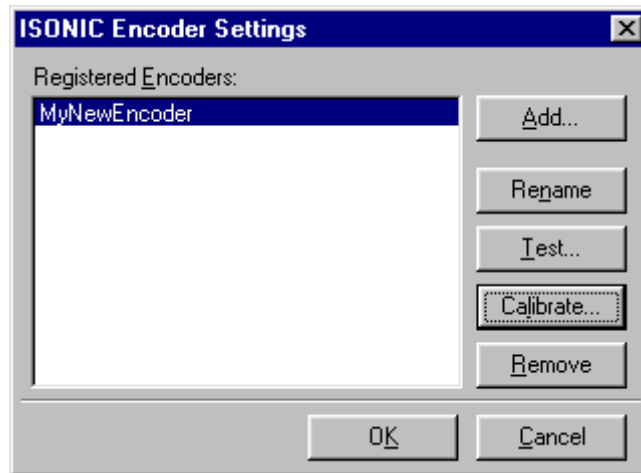

To update the registry of **ISONIC 2007** with new encoder data click on the **OK** or press  on front panel keyboard or **Enter** or **<Alt>+<Y>** on external keyboard – this will automatically return to **ISONIC 2007 Settings Menu**



While running encoder calibration next time:

- ❑ Click on **Add...** or press **<Alt>+<A>** on external keyboard to proceed with next new encoder by the same way as described above
- ❑ Click on **Rename** or press **<Alt>+<N>** on external keyboard to rename the selected encoder
- ❑ Click on **Test** or press **<Alt>+<T>** on external keyboard to check the accuracy of selected encoder calibration
- ❑ Click on **Calibrate** or press **<Alt>+<L>** on external keyboard to recalibrate selected encoder
- ❑ Click on **Remove** or press **<Alt>+<R>** on external keyboard to remove selected encoder from the registry of **ISONIC 2007**
- ❑ Click on the **Cancel** or press  on front panel keyboard or press **Esc** or **<Alt>+<C>** on external keyboard to negate all changes and return to **ISONIC 2007 Settings Menu**
- ❑ Click on the **OK** or press  on front panel keyboard or **Enter** or **<Alt>+<K>** on external keyboard to update the registry of **ISONIC 2007** and return to **ISONIC 2007 Settings Menu**



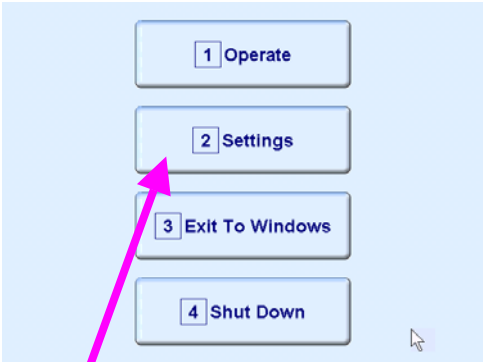

## 9. Miscellaneous

# 9.1. International Settings



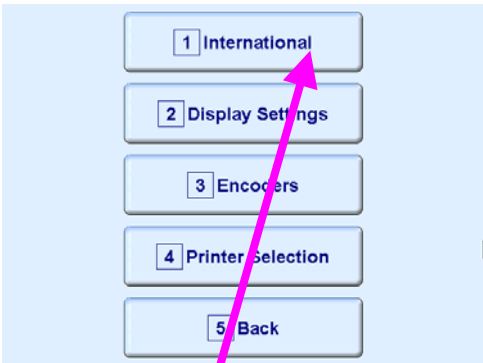

In the **ISONIC 2007 start screen** **click on** or press  on front panel keyboard or **F2** on external keyboard



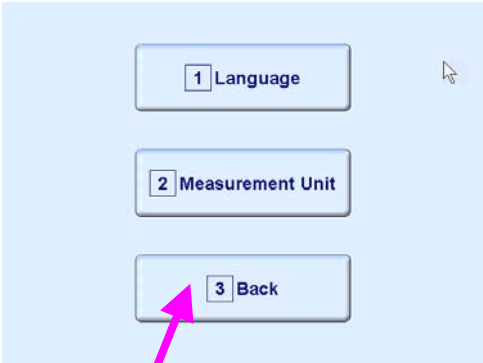

In the appeared **ISONIC 2007 Settings Menu** **click on** or press  on front panel keyboard or **F1** on external keyboard , the **International Settings** screen appears:

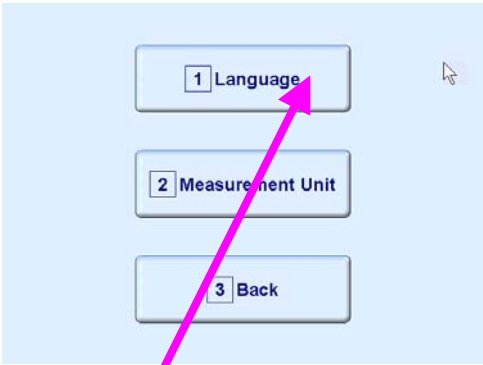

To return to **ISONIC 2007 Settings Menu** **click on** or press  or  on front panel keyboard or **F3** or **Esc** on external keyboard

### 9.1.1. Language



In the **International Settings** screen **clicks on** or press  on front panel keyboard or **F1** on external keyboard

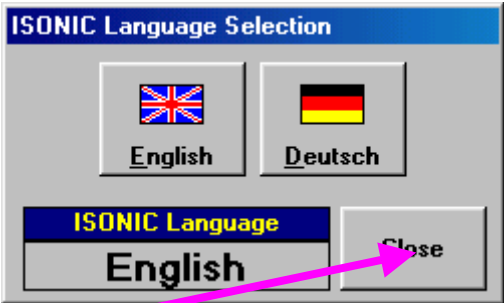

Select language then **click on**

 Standard languages of **ISONIC 2007** are English and German. Other languages are available upon request

### 9.1.2. Metric and Imperial Units

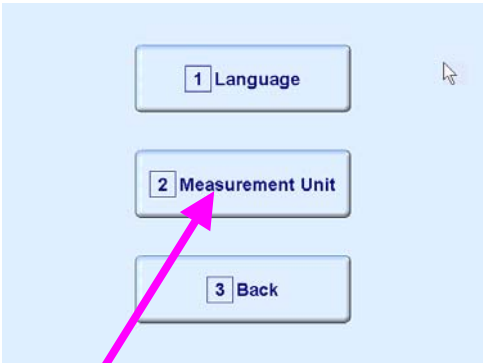

In the **International Settings** screen **click on** or press  on front panel keyboard or **F2** on external keyboard

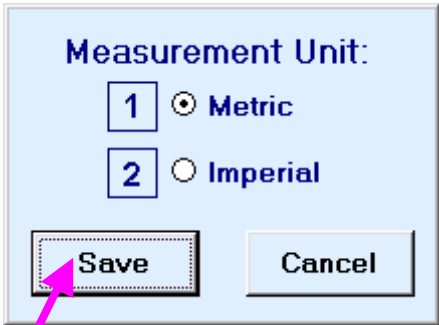

Select measurement units then **click on**

# 9.2. Display Settings



In the **ISONIC 2007 Settings Menu** click on or press  on front panel keyboard or **F2** on external keyboard

## 9.2.1. A-Scan Color Scheme



In the **Display Settings Menu** click on or press  on front panel keyboard or **F1** on external keyboard then mark selected color scheme for both CH 1 and CH 2

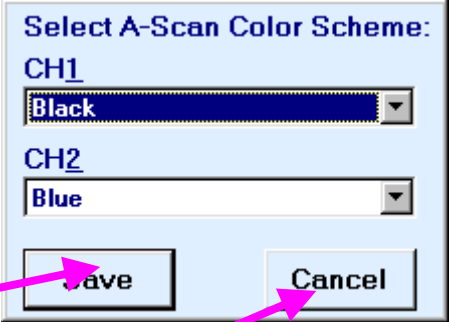

then click on

To negate new selection click on



There are 4 A-Scan Color Schemes available:

Black

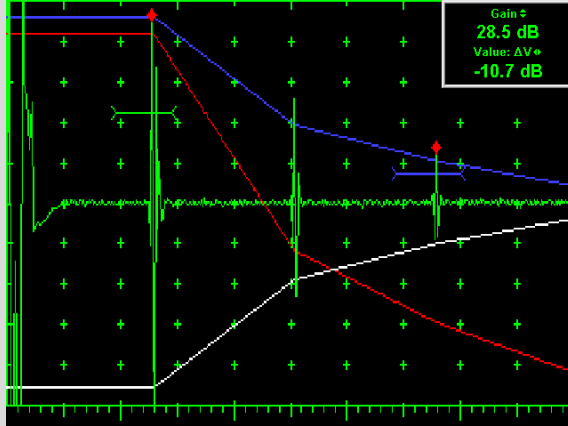

Gray

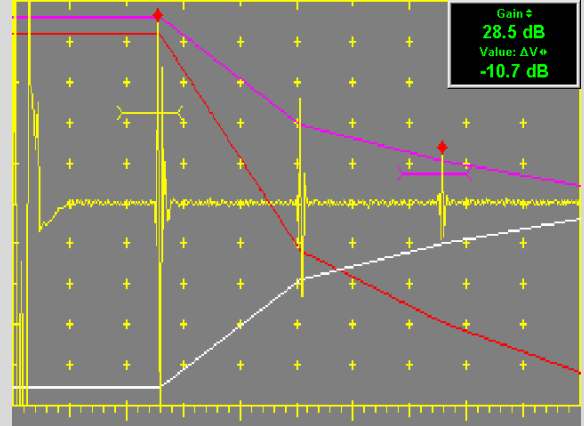

Blue

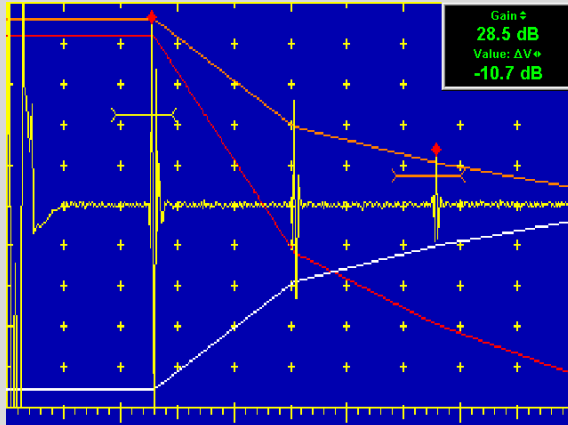

White

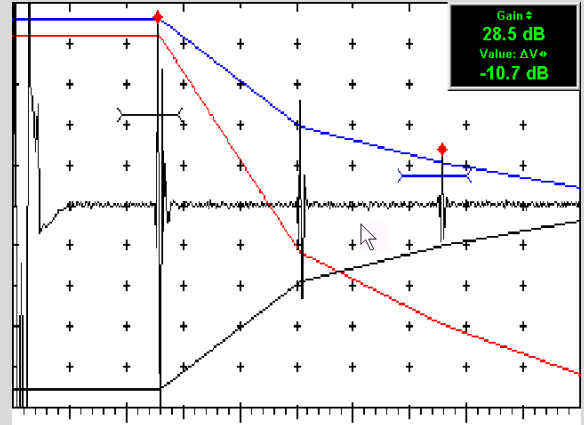

## 9.2.2. TOFD Display Settings

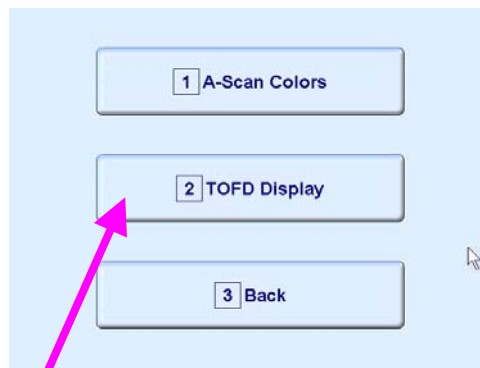

In the **Display Settings Menu** **click on** or press  on front panel keyboard or **F2** on external keyboard then check the selected options:

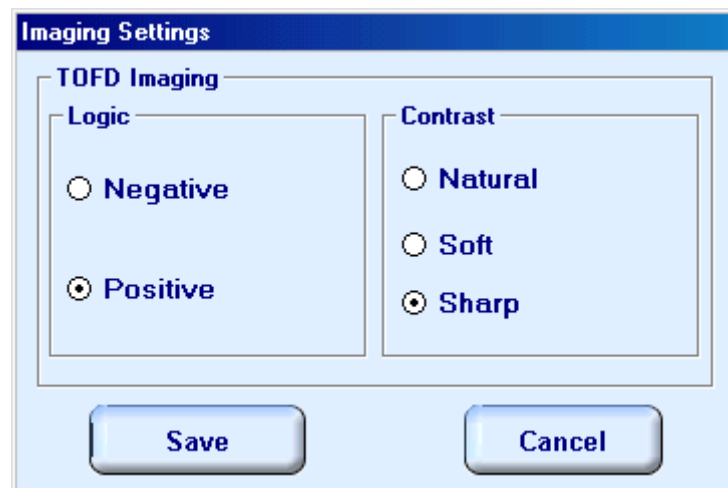



## Natural Contrast TOFD Display

### Negative

256 brightness levels of **TOFD Map** from absolutely white to absolutely black are distributed for RF signals, which's half waves do vary from minus 100% to plus 100% of A-Scan display height. Positive half wave signals equal or exceeding plus 100% of A-Scan display height are represented by absolutely black color. Negative half wave signals equal or exceeding minus 100% of A-Scan display height are represented by absolutely white color

### Positive

256 brightness levels of **TOFD Map** from absolutely black to absolutely white are distributed for RF signals, which's half waves do vary from minus 100% to plus 100% of A-Scan display height. Positive half wave signals equal or exceeding plus 100% of A-Scan display height are represented by absolutely white color. Negative half wave signals equal or exceeding minus 100% of A-Scan display height are represented by absolutely black color

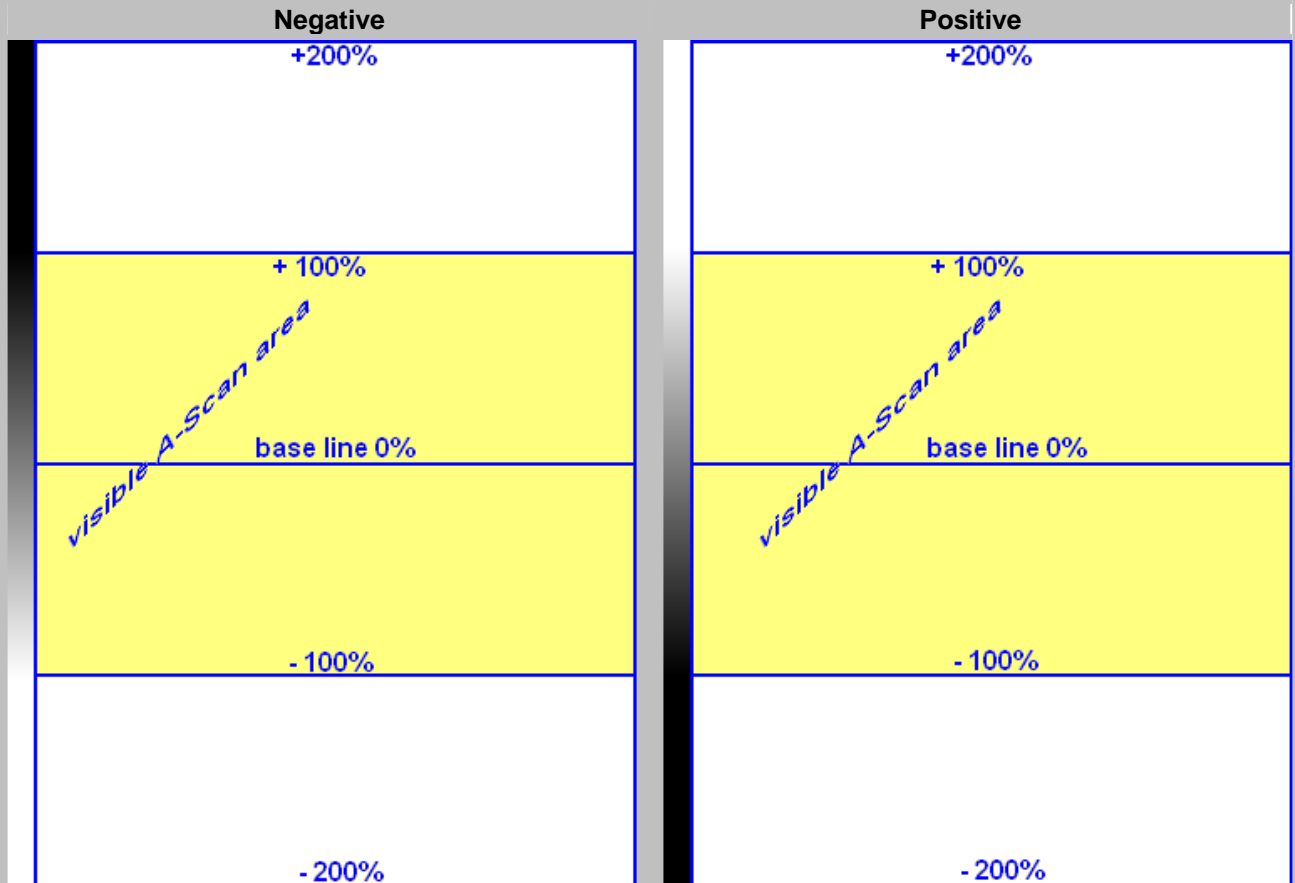





## Soft Contrast TOFD Display

### Negative

256 brightness levels of **TOFD Map** from absolutely white to absolutely black are distributed for RF signals, which's half waves do vary from minus 200% to plus 200% of A-Scan display height. Positive half wave signals equal or exceeding plus 200% of A-Scan display height are represented by absolutely black color. Negative half wave signals equal or exceeding minus 200% of A-Scan display height are represented by absolutely white color

### Positive

256 brightness levels of **TOFD Map** from absolutely black to absolutely white are distributed for RF signals, which's half waves do vary from minus 200% to plus 200% of A-Scan display height. Positive half wave signals equal or exceeding plus 200% of A-Scan display height are represented by absolutely white color. Negative half wave signals equal or exceeding minus 200% of A-Scan display height are represented by absolutely black color

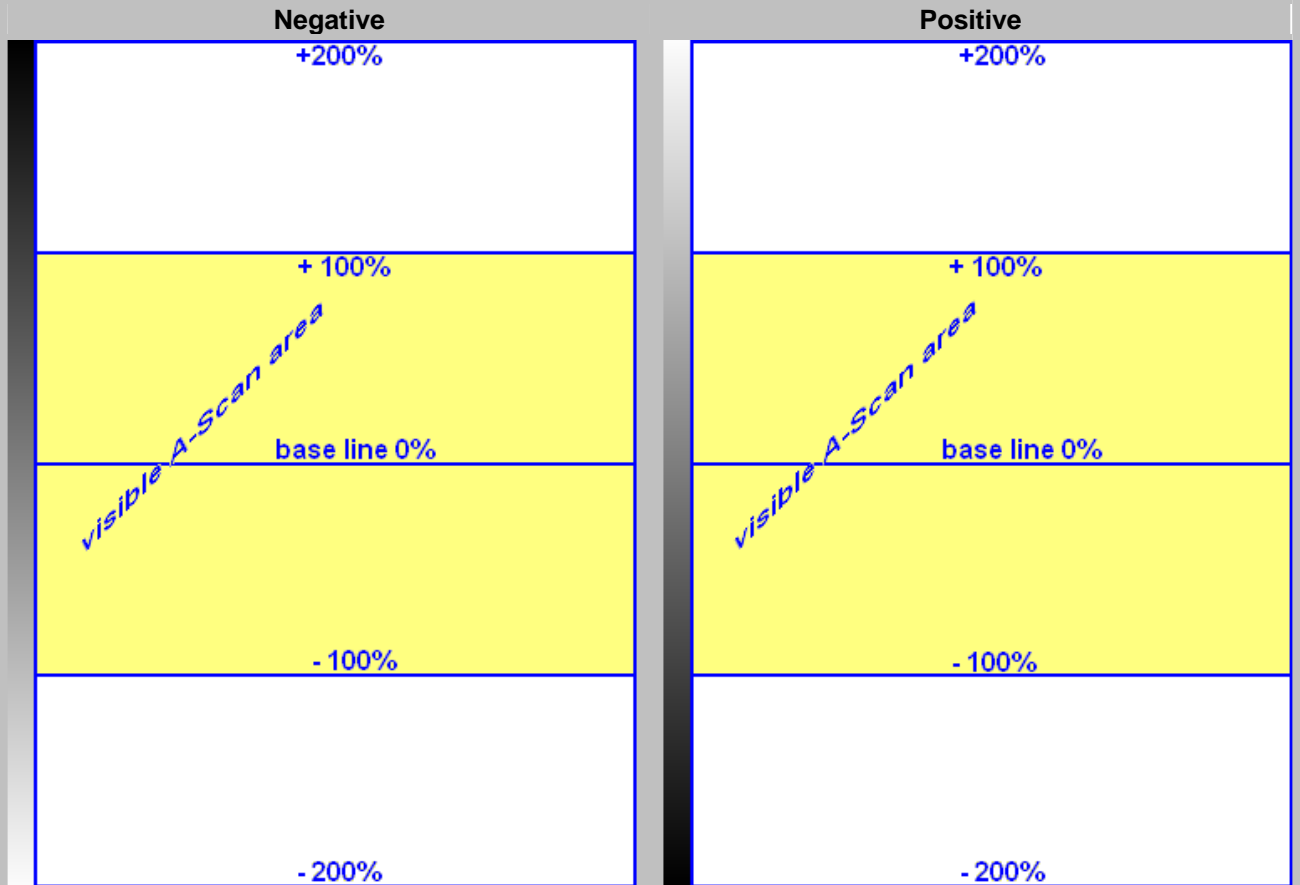



## Sharp Contrast TOFD Display

### Negative

256 brightness levels of **TOFD Map** from absolutely black to absolutely white are distributed for RF signals, which's half waves do vary from minus 50% to plus 50% of A-Scan display height. Positive half wave signals equal or exceeding plus 50% of A-Scan display height are represented by absolutely black color. Negative half wave signals equal or exceeding minus 50% of A-Scan display height are represented by absolutely white color

### Positive

256 brightness levels of **TOFD Map** from absolutely black to absolutely white are distributed for RF signals, which's half waves do vary from minus 50% to plus 50% of A-Scan display height. Positive half wave signals equal or exceeding plus 50% of A-Scan display height are represented by absolutely white color. Negative half wave signals equal or exceeding minus 50% of A-Scan display height are represented by absolutely black color



## 9.3. Firing Mode



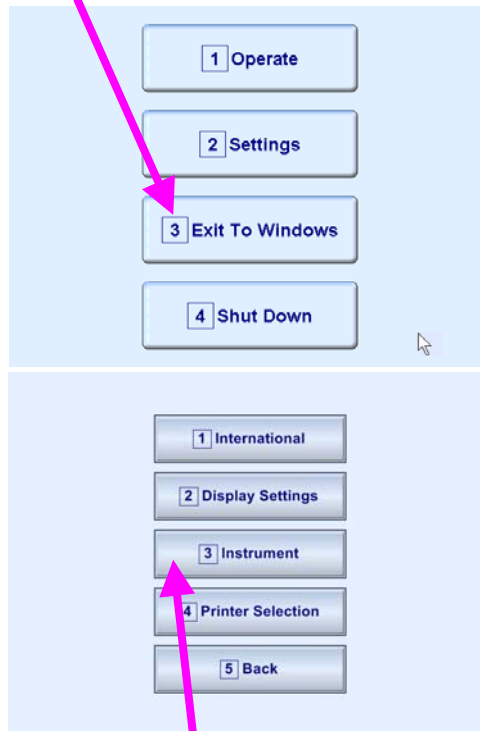

The content the present paragraph is applicable to ISONIC 2007 instruments manufactured on April 10, 2012 or later and to earlier manufactured instruments provided their firmware was modified by Sonotron NDT on April 10, 2012 or later

In the **ISONIC 2007 start screen** click on or press 

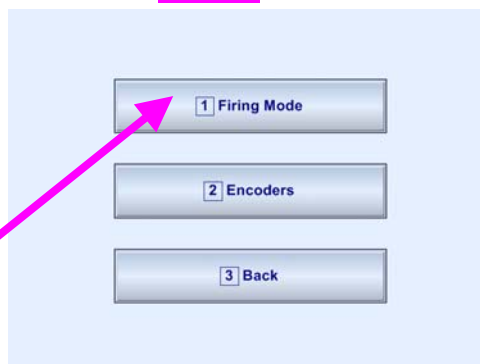

In the appeared **ISONIC 2007 Settings Menu** click on or press 



Then click on or press  - this will open simple dialogue for selection of **Firing Mode** for **Multi Channel** inspection:

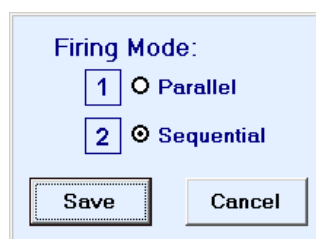



## 9.4. Printer Selection

This option is available if there are more than 1 printer drivers installed in **ISONIC 2007**

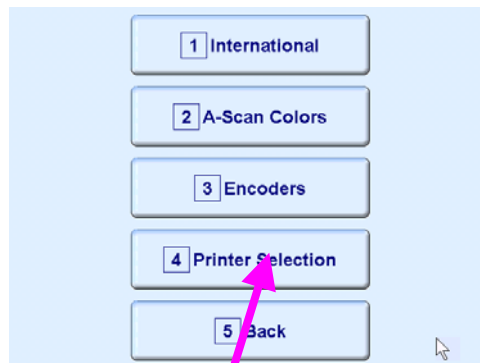

In the **ISONIC 2007 start screen** click on **2** or press  on front panel keyboard or **F2** on external keyboard



In the appeared **ISONIC 2007 Settings Menu** click on **4** or press  on front panel keyboard or **F4** on external keyboard

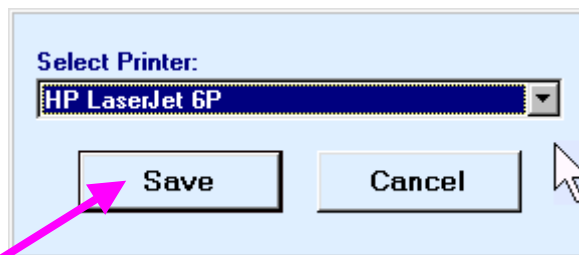

Select printer then click on **Save**

## 9.5. Exit to Windows



In the **ISONIC 2007 start screen** click on **3** or press  on front panel keyboard or **F3** on external keyboard

To return to **ISONIC 2007** Operation double click on icon  located in the Windows Desktop



Exit to Windows is required for:

- Connection to network
  - Printing inspection results to network printer
  - Transferring data to / from remote PC
- Installing printer driver(s)
- Installing USB memory stick (disk on key) driver (for **ISONIC 2007** instruments running under Windows 98 SE Operating System)
- Quasi-disk management

In order to prevent overloading of **ISONIC 2007** quasi-disk and memory with data and non **ISONIC 2007** software that may affect instrument performance it's not allowed to install non **ISONIC 2007** software except drivers noted above. Affecting of instrument performance through installing on non **ISONIC 2007** software except drivers noted above is the warranty exemption damage

## 9.6. Connection to Network

To connect **ISONIC 2007** to local area network using Ethernet connector (refer to paragraph 4.2 of this Operating Manual) and standard Windows rules

## 9.7. External USB Devices

### 9.7.1. Mouse

Use one of 2 USB Connectors (refer to paragraph 4.2 of this Operating Manual). **ISONIC 2007** finds and registers external USB mouse automatically through standard Windows routine. Microsoft optical mouse is recommended

### 9.7.2. Keyboard

Use one of 2 USB Connectors (refer to paragraph 4.2 of this Operating Manual). **ISONIC 2007** finds and registers USB keyboard automatically through standard Windows routine. Microsoft keyboard is recommended

### 9.7.3. Memory Stick (Disk on Key)

Use one of 2 USB Connectors (refer to paragraph 4.2 of this Operating Manual)

**ISONIC 2007** running under Windows XP Embedded finds and registers USB memory stick (disk on key) automatically through standard Windows routine.

For **ISONIC 2007** instruments running under Windows 98 SE preliminary driver setup is required. To install driver use network connection (refer to paragraph 8.5 of this Operating Manual)

### 9.7.4. Printer

Use one of 2 USB Connectors (refer to paragraph 4.2 of this Operating Manual). Preliminary driver setup is required. To install driver use network connection (refer to paragraph 8.5 of this Operating Manual) or USB memory stick (disk on key) if it's already registered in **ISONIC 2007**

## 9.7.5. ISONIC Alarmer

For a variety of manual and automatic inspection applications it may be necessary:

- generating sound alarm on defect detection
- controlling some external devices, such as sorters, multi-element go/no go display panels, etc
- starting inspection and recording process upon receiving triggering signal from an external device
- etc

A variety of above tasks is resolved by simple **ISONIC Alarmer** (part # SE 554780987), which is interfaced to ISONIC 2005, 2006, 2007, 2008 instrument through USB port



- **ISONIC Alarmer** may be connected to the instrument at any moment since **ISONIC 2007 Start Screen** became active (refer to paragraph 4.3 of this Operating Manual)
- **ISONIC Alarmer** may be disconnected from the instrument at any moment prior to shut down (refer to paragraph 4.3 of this Operating Manual)

**ISONIC Alarmer** includes:

- Internal Speaker, which is switched ON / OF according to alarm logic settings of UDS 3-5 Pulser Receiver in the ISONIC 2005, 2006, 2007 instruments / UDS 3-6 Pulser Receiver of ISONIC 2008 Instrument
- Speaker Volume Control Wheel
- Headphone Connector
- Input / Output Control chip
- 25-pin programmable Input / Output interface

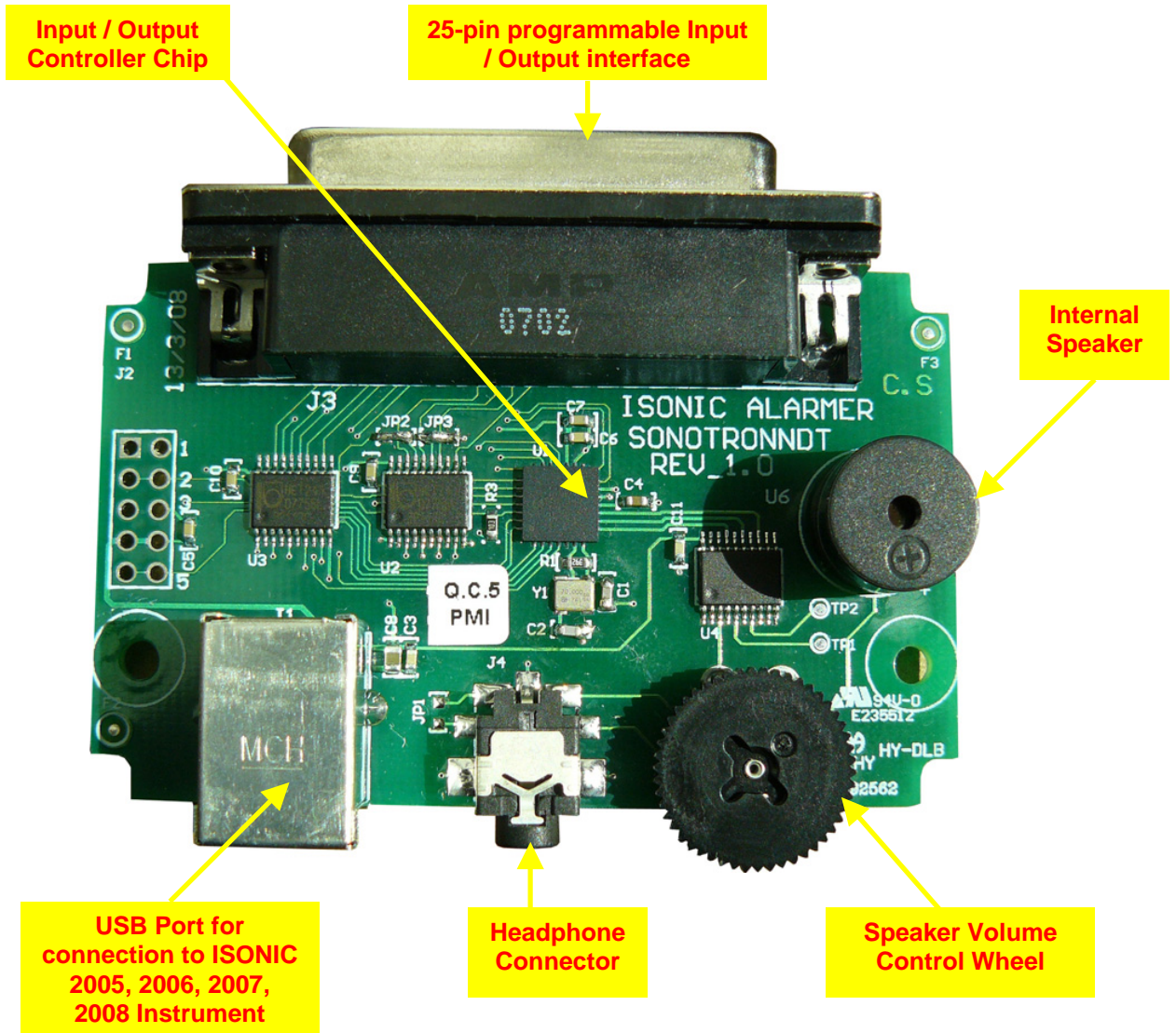

Initially **ISONIC Alarmer** is configured to deliver sound through speaker and headphone connector (standard configuration)

25-pin input / output interface is configured according to the duty book, which is agreed with the customer (optional configuration)



Standard configuration pin-out of 25-pin input / output interface D-Type connector is shown below:

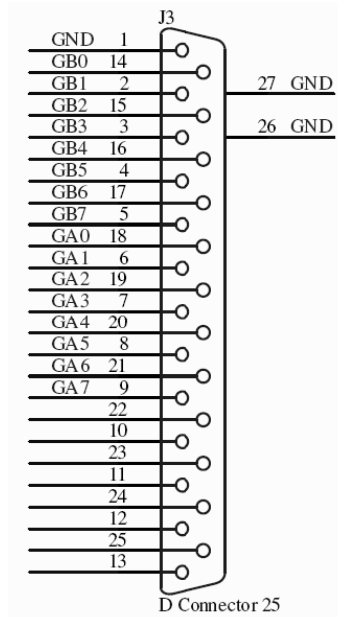

| Pin Number | Function  |
|------------|---|
| 1          | Ground  |
| 2          | Alarm Gate B – Channel 1 (Only Channel for ISONIC 2005, 2006) |
| 3          | Alarm Gate B – Channel 3                                      |
| 4          | Alarm Gate B – Channel 5                                      |
| 5          | Alarm Gate B – Channel 7                                      |
| 6          | Alarm Gate A – Channel 1 (Only Channel for ISONIC 2005, 2006) |
| 7          | Alarm Gate A – Channel 3                                      |
| 8          | Alarm Gate A – Channel 5                                      |
| 9          | Alarm Gate A – Channel 7                                      |
| 10         | NC  |
| 11         | NC  |
| 12         | NC  |
| 13         | NC  |
| 14         | Alarm Gate B – Channel 0                                      |
| 15         | Alarm Gate B – Channel 2                                      |
| 16         | Alarm Gate B – Channel 4                                      |
| 17         | Alarm Gate B – Channel 6                                      |
| 18         | Alarm Gate A – Channel 0                                      |
| 19         | Alarm Gate A – Channel 2                                      |
| 20         | Alarm Gate A – Channel 4                                      |
| 21         | Alarm Gate A – Channel 6                                      |
| 22         | NC  |
| 23         | NC  |
| 24         | NC  |
| 25         | NC  |

## 9.8. External VGA screen / VGA projector

Connect to appropriate connector (refer to paragraph 4.2 of this Operating Manual) while at least one of 2 devices either **ISONIC 2007** or external screen / projector is switched OFF then switch on one or both devices

## 9.9. Software Upgrade

Refer to <http://www.sonotronndt.com/support.htm> in the Internet

## 9.9. ISONIC Office and ISONIC Office 2005 Software packages for office PC

**ISONIC Office** and **ISONIC Office 2005** software packages allow performing of all-function postprocessing for all types of inspection files captured using **ISONIC 2007** in an office PC. All postprocessing procedures are identical to the postprocessing procedures and menus inside the unity itself. If Microsoft Word is installed in an office PC then at any moment postprocessing snapshots including all graphics and accompanying setup and / or measurement data may be converted into the MS Word® \*.doc file

## 9.10. ISONIC Par2Txt Converter Software package



Contents of this chapter is valid for the **ISONIC Par2Txt Converter** SW Package version 2.0.0.1 or higher

**ISONIC Par2Txt Converter** converts variously configured \*.PAR files created by **ISONIC 2001** and **ISONIC 2007** instruments into \*.txt files. Both pure **A-Scans** and **A-Scans** accompanied with frequency domain (**FFT**) graphs are presented in ASCII format in \*.txt files. This allows further off-line signal analysis using popular software packages Mathlab®, Labview®, and the like



Click on *Start* then select *Programs* ⇒ *ISONIC* ⇒ *ISONIC Par2Txt Converter* or click on  icon located in the desktop to run **ISONIC Par2Txt Converter** - window as below appears:

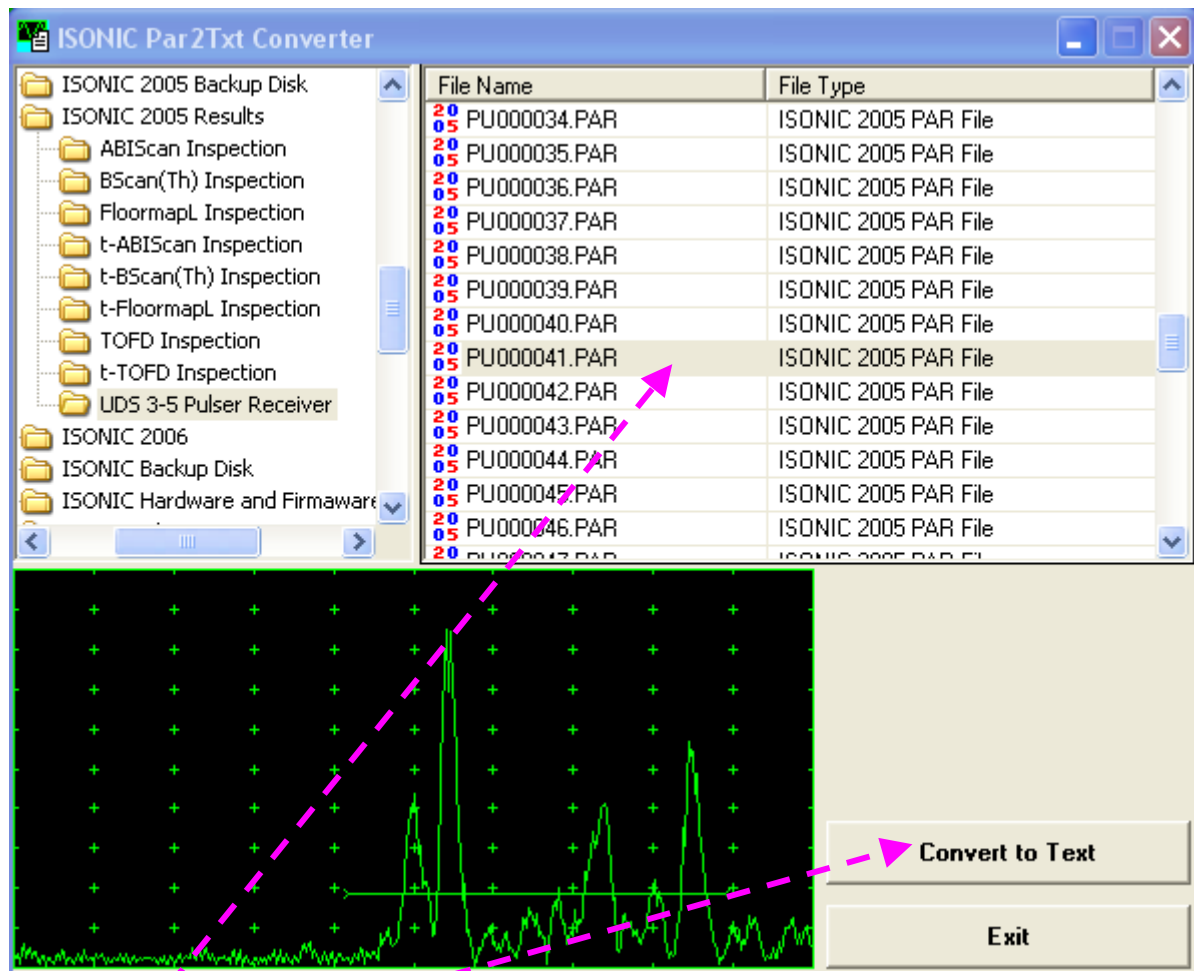

Select the **file of interest** then **click on**

As a result the corresponding **\*.txt file** appears

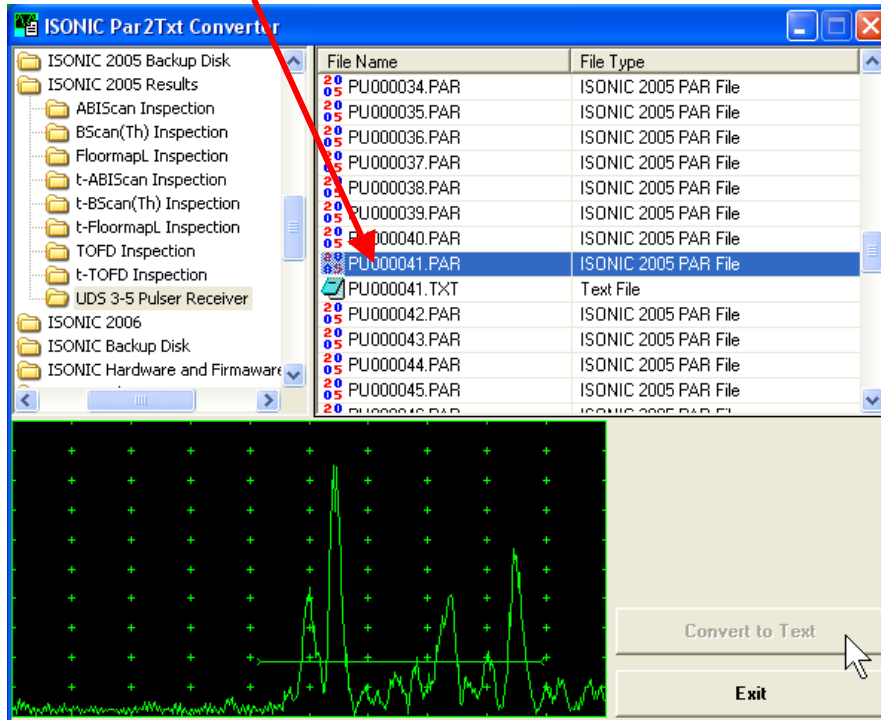

To preview the contents of \*.txt file **double click on its name** or mark it and **click on**

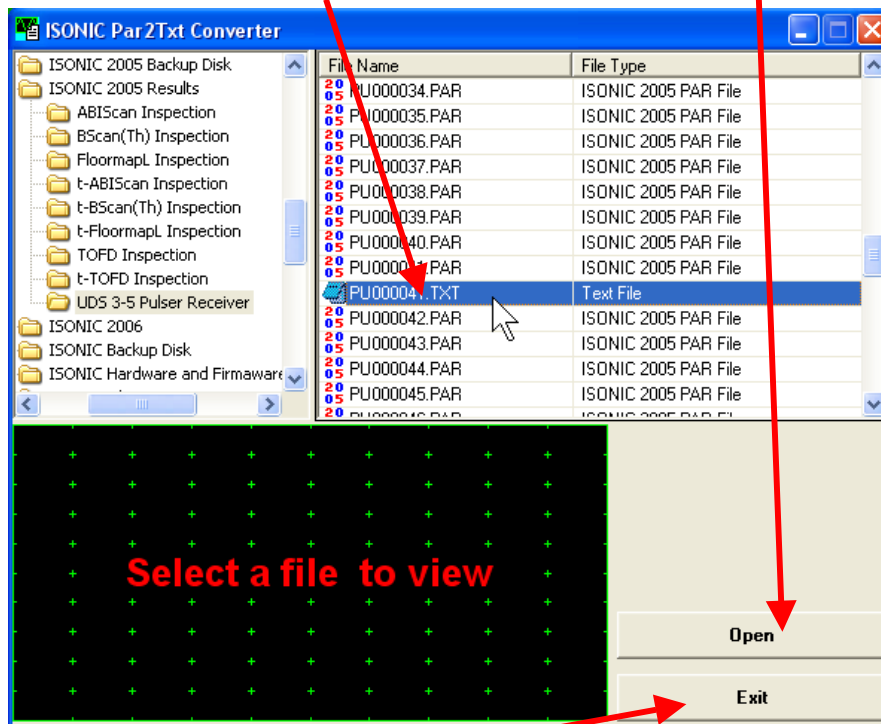

To end ISONIC Par2Txt Converter session **click on**

## 9.11. ISONIC D-Line and ISONIC D-Spreadsheet Creator Software packages

ISONIC D-Line and ISONIC D-Spreadsheet Creator software packages for office computer equipped with Microsoft® Office allow converting of t-BScan(Th)/BScan(Th) files (special format \*.bsi) into Microsoft® Excel (.xls) spreadsheet file



### ISONIC D-Line



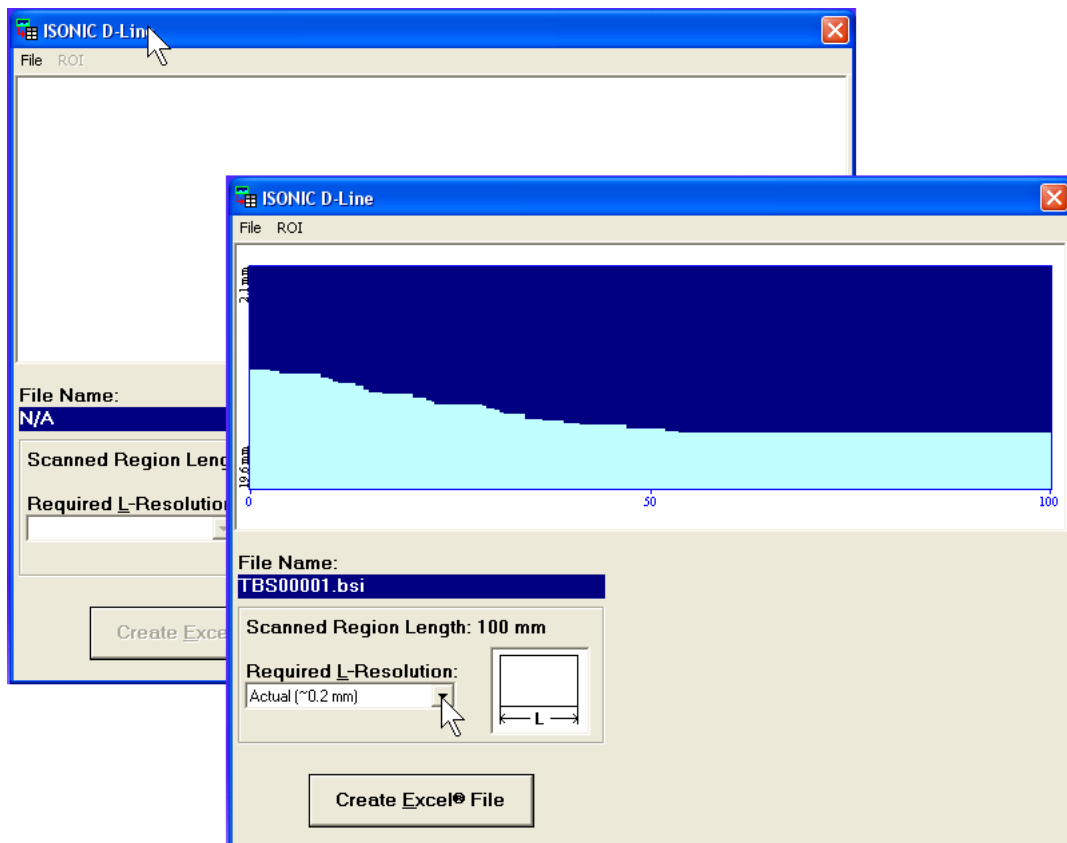



Click on *Start* then select *Programs* ⇒ *ISONIC* ⇒ *ISONIC D-Line* or click on  icon located in the desktop to run **ISONIC D-Line**

- **File → Open** allows selection and loading of \*.bsi format t-BScan(Th)/BScan(Th) data file



On completing download:

- **ROI → ON** – generates *cursor representing sound path* of probe's central beam in the object under test that may be guided over **t-BScan(Th) / BScan(Th)** image using either mouse or ,  buttons on keyboard – corresponding **A-Scan** is recovered synchronously according to cursor position. To select reference **A-Scan** left mouse click or press **Enter** on external keyboard – this generates off-line **Gate**

**A** controls , , , , ,  allowing to redefine **Region Of Interest** for **t-BScan(Th) / BScan(Th)** imaging

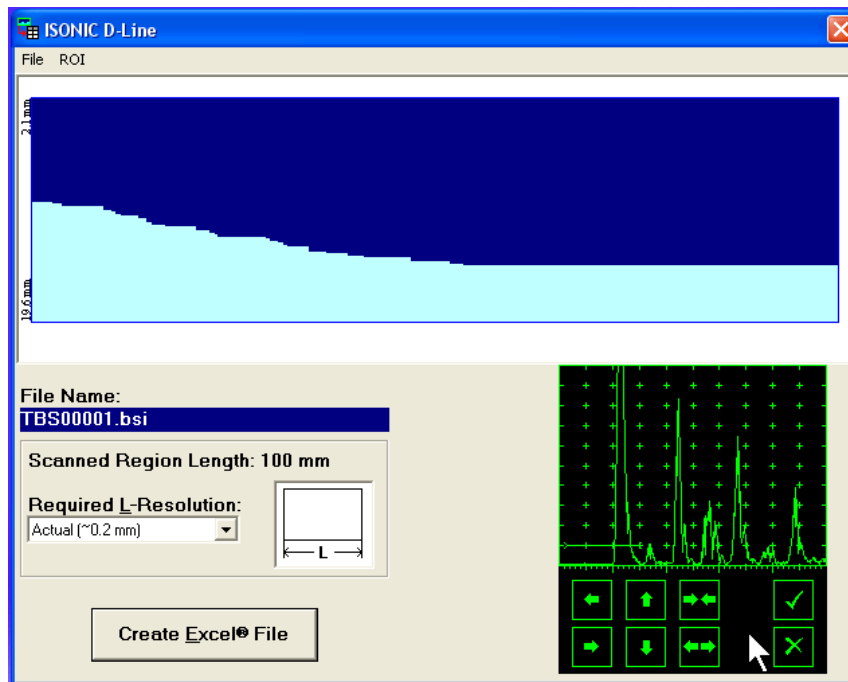

Upon completing redefining of **Region Of Interest** click on  – this applies new **Gate A** to all captured **A-Scans** and updates **t-BScan(Th) / BScan(Th)** image accordingly

To interrupt selection of reference of **A-Scan** right mouse click or press **ESC** on keyboard

To interrupt re-adjustment of **Region Of Interest** after selection of reference of **A-Scan** click on 

- **ROI→OFF** – negates **Gate A** re-adjustment and returns to originally recorded **t-BScan(Th) / BScan(Th)** image and original **Gate A** setting

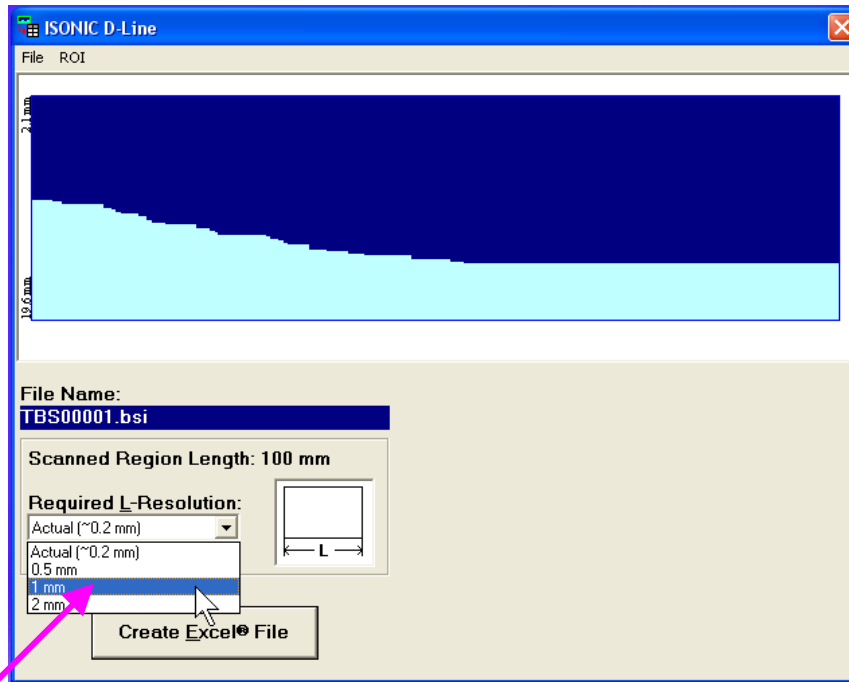

- Required L-Resolution** – this control allows selecting of necessary longitudinal scanning coordinate increments for depth spreadsheet to be created. Best possible resolution (actual) corresponding to minimal possible increment is default – it corresponds to single depth reading per each coordinate. On selecting coordinate increment larger than actual **ISONIC D-Line** software will analyze all depth readings with actual resolution for each interval covered by selected increment and place minimal values into corresponding cells

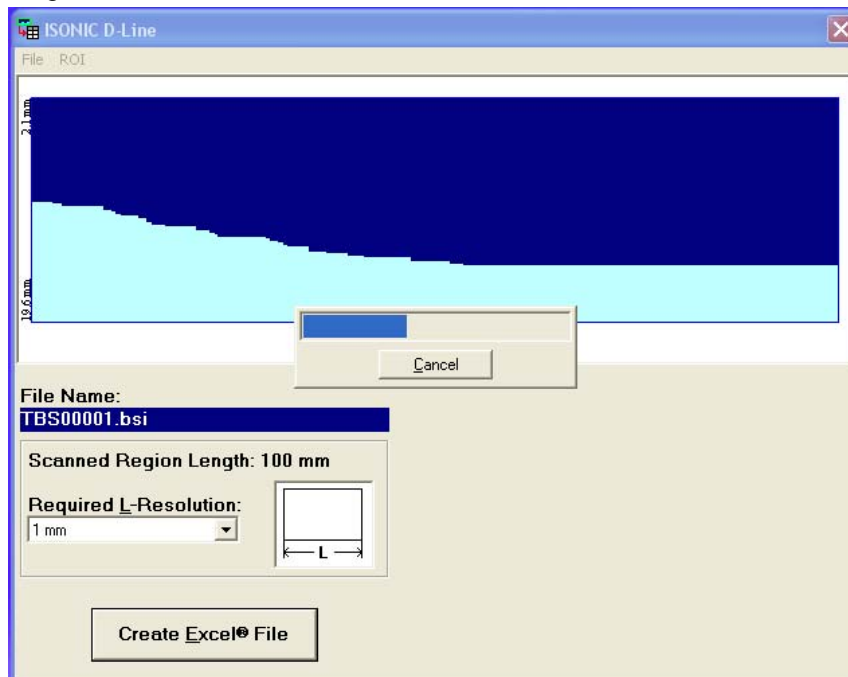

- Create Excel® File** – clicking on this button will initiate automatic creation of spreadsheet followed by starting Microsoft® Excel software
- File→Exit** – quits **ISONIC D-Line** software

## ISONIC D-Spreadsheet Creator



Click on *Start* then select *Programs* ⇒ *ISONIC* ⇒ *ISONIC D-Spreadsheet Creator* or click on the icon located in the desktop to run **ISONIC D-Spreadsheet Creator**

**File → Open** allows selection and loading of \*.bsi format t-BScan(Th)/BScan(Th) data file

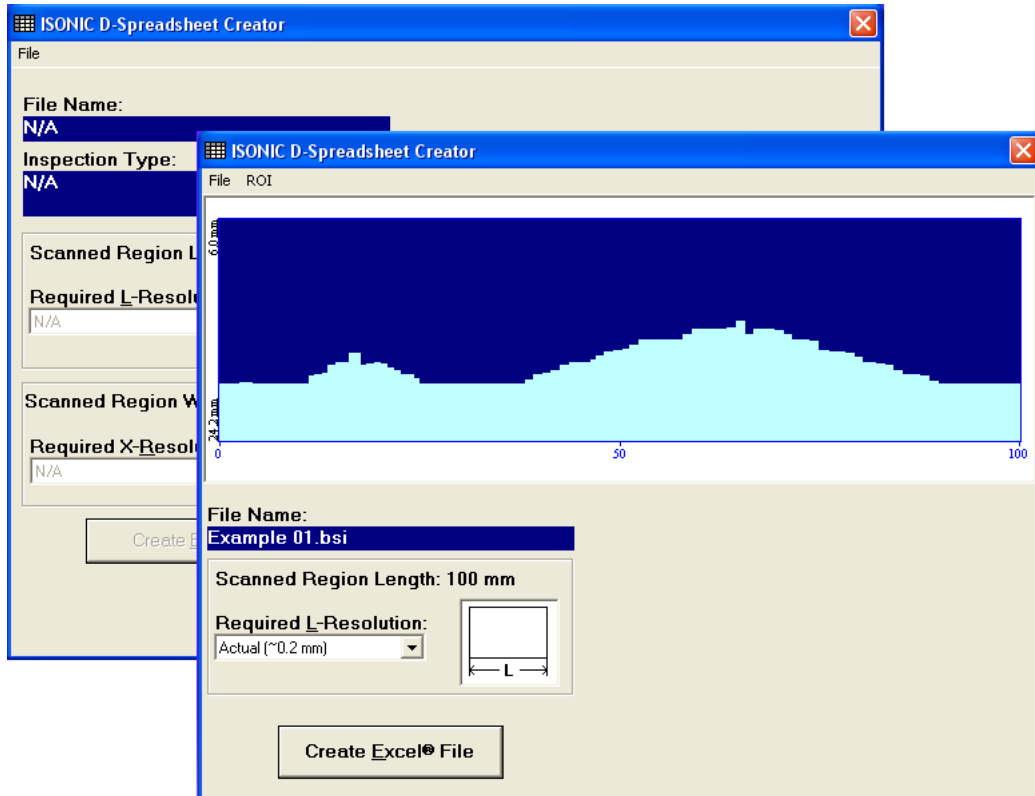

- **File → Open** allows selection and loading of \*.bsi format t-BScan(Th)/BScan(Th) data file

All further operations are identical to above described for **ISONIC D-Line**



## 9.12. Charging Battery

Battery of **ISONIC 2007** may be charged while disconnected from the unit. The special charger is required (refer to Chapter 3 of this Operating Manual). Connect charger to the battery as it is shown below



There is **Charge** LED on the charger. While charging the battery this LED emits solid light. **Charge** LED starts flashing upon charge is completed



If a battery is new and almost completely discharged then "boiling" effect in the electrolyte may start earlier than battery is fully charged. In order to prevent battery charger stops on detecting boiling "boiling" effect:

- ❑ If temperature inside battery does not exceed 60°C deg limit then **Charge** LED starts flashing – for such case it is necessary to disconnect charger from mains for few minutes and to connect it to mains again. The normal charging will continue
- ❑ If temperature inside battery exceeds 60°C deg limit then **Temp** LED starts flashing – for such case it is necessary to disconnect charger from mains for at least 2 hours and to connect it to mains again. The normal charging will continue

After few charge / discharge cycles battery becomes "trained" and probability of "boiling" effect decreases to almost zero

## 9.13. Silicon Rubber Jacket

Establishing Image:



Remove the plastic screw-caps from both sides of the handle using a pair of tweezers:



Remove the screw (and washer) from each side of the handle:



Remove the handle and put it aside (along with all the metal parts):



Align the holes with the ports on the machine. Slip the Silicone Rubber Jacket around the machine until it fits properly and covers all edges:



A view of the front and back side:



Put the handle back in position (along with all the metal parts):



Screw-in the screw (and washer) on each side of the handle:

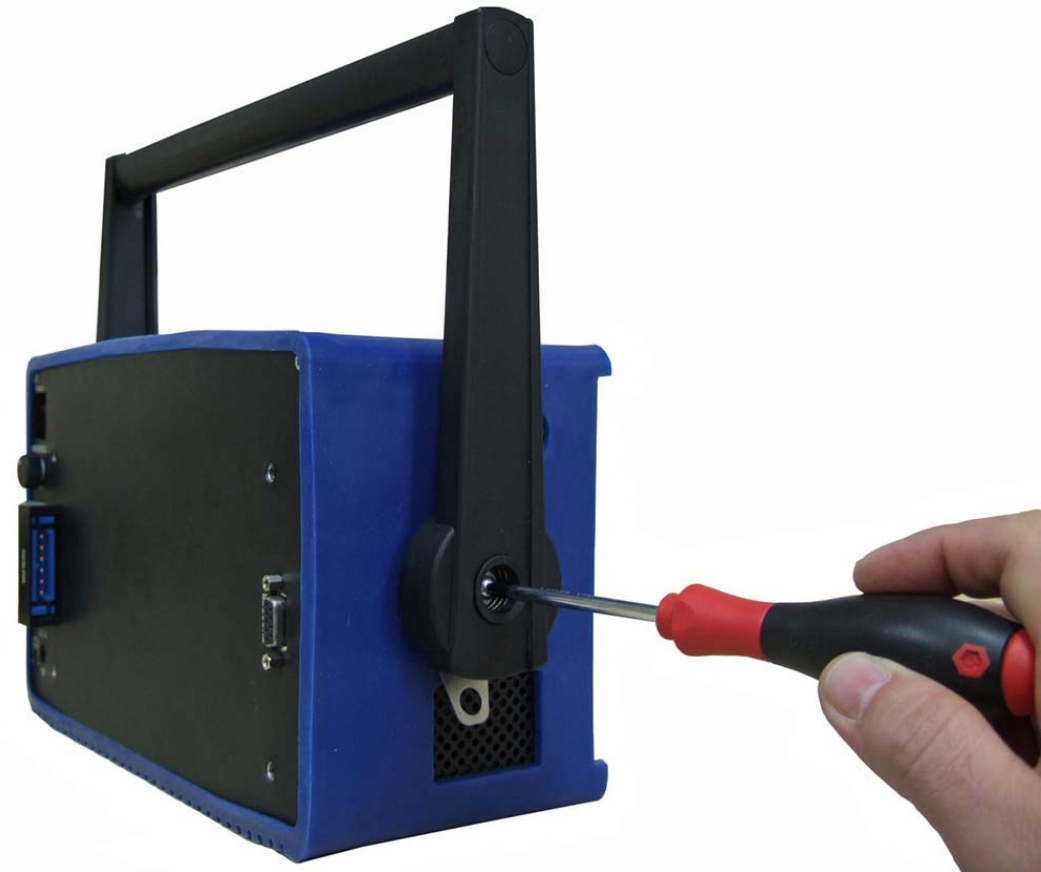

Push the plastic screw caps on both sides of the handle into place:



DONE!



# 10. Dual Channel TOFD preamplifier

SA 80442 Fixed Gain Dual Channel Preamplifier Package from Sonotron NDT improves long cable connection to ultrasonic probes, which may be required in NDT practice very often. Typical applications are TOFD, Corrosion Detection, and the like implemented through use of probes fitted into the scanner / crawler frame



**Technical Data:**

|  |   |
|--|---|
| Independent Channels                   | <b>2</b>  |
| Frequency Band                         | <b>0.2...25 MHz at -3 dB</b>  |
| Advanced Low Noise Design              | <b>34 nV peak to peak input referred to 20 dB gain / 25 MHz bandwidth</b> |
| Gain                                   | <b>20 dB</b>  |
| Output Impedance                       | <b>50 Ω</b>   |
| Output Driving Capacity – Cable Length | <b>≤ 30 m</b>   |
| Terminals                              | <b>Input 2 X LEMO 00<br/>Output 2 X LEMO 01</b>                           |
| Power                                  | <b>4 X Dry Alkaline Batteries AA Size</b>                                 |
| Flashing LED Indicators                | <b>Channel 1 Switch ON<br/>Channel 2 Switch ON<br/>Low Battery</b>        |
| Housing                                | <b>Sealed IP 67 Rugged Aluminum Case</b>                                  |
| Dimensions                             | <b>62 X 30 X 112 mm (2.44 X 1.18 X 4.4 “)</b>                             |
| Weight                                 | <b>320 g (0.7 lbs)</b>  |